

**Impulse Winding  
Tester  
SME1203-1**

**User Manual**

**scientific**

---

**Copyright © Scientific All rights reserved.**

This instrument contains proprietary information, no part of this manual may be photocopied, reproduced or translated without any prior written consent.

Information in this manual supercede all corresponding previous released material.

Scientific continues to improve products and reserves rights to amend part or all of the specifications, procedures, equipment at any time without notice.

Rev 1.02 / 1015

**Scientific Mes-Technik Pvt. Ltd.,**

B-14 Industrial Estate, Pologround,  
INDORE 452015(INDIA)  
Tel : 0731-2422330/31/32/33  
Fax : 0731-2422334,561641  
Email : [info@scientificindia.com](mailto:info@scientificindia.com)



## Safety Summary

The following general safety precautions must be observed during all phases of operation, service, and repair of this instrument. Failure to comply with these precautions or with specific WARNINGS elsewhere in this manual may impair the protection provided by the equipment. In addition it violates safety standards of design, manufacture, and intended use of the instrument.

We assume no liability for the customer's failure to comply with these requirements.

### **Ground the Instrument**

To avoid electric shock hazard, the instrument chassis and cabinet must be connected to a safety earth ground by the supplied power cable with earth blade.

### **DO NOT Operate In an Explosive Atmosphere**

Do not operate the instrument in the presence of flammable gasses or fumes. Operation of any electrical instrument in such an environment constitutes a definite safety hazard.

### **Keep Away From Live Circuits**

Operating personnel must not remove instrument covers. Component replacement and internal adjustments must be made by qualified maintenance personnel. Do not replace components with the power cable connected. Under certain conditions, dangerous voltages may exist even with the power cable removed. To avoid injuries, always disconnect power and discharge circuits before touching them.

### **DO NOT Service or Adjust Alone**

Do not attempt internal service or adjustment unless another person, capable of rendering first aid and resuscitation, is present.

### **DO NOT Substitute Parts or Modify Instrument**

Because of the danger of introducing additional hazards, do not install substitute parts or perform unauthorized modifications to the instrument. Return the instrument to one of Scientific Sales and Service Office for service and repair to ensure that safety features are maintained.

### **Dangerous Procedure Warnings**

**Warnings**, such as the example below, precede potentially dangerous procedures throughout this manual. Instructions contained in the warnings must be followed.

**Warning: Dangerous voltages, capable of causing death, are present in this instrument. Use extreme caution when handling, testing, and adjusting this instrument.**

# Impulse Winding Tester SME1203-1

## Table Of Contents

<b>Chapter 1 General Information</b> .....	7
1.1 Product Introduction.....	7
1.2 Incoming Inspection.....	7
1.3 Power Requirements.....	8
1.4 Operation Environment.....	9
1.5 Comparison Methods.....	9
1.5.1 Area Size Comparison.....	9
1.5.2 Differential Areal Comparison.....	10
1.5.3 Corona Discharge Comparison.....	11
1.5.4 Differential Phase Comparison.....	11
<b>Chapter 2 SME1203-1 Overview</b> .....	13
2.1 Front Panel Summary.....	13
2.2 Rear Panel Summary.....	15
2.3 Display Area Definition.....	17
2.4 Basic Operation.....	18
<b>Chapter 3 DISP Menu Operation</b> .....	21
3.1 MEAS DISP Page.....	21
3.1.1 TIME BASE ZOOM Function.....	24
3.1.2 Comparator Setup.....	24
3.1.3 Measurement Function.....	30
3.1.4 File Manager.....	36
3.1.5 Useful Tools.....	39
3.1.6 Impulse Voltage.....	40
3.1.7 Sample Rate.....	40
3.2 Statistic Display Page.....	43
3.2.1 Statistic Function ON/OFF.....	44
3.2.2 Clear the Statistic Data.....	44
3.2.3 Save the Statistic Data to the Current File.....	45
3.2.4 File Manager.....	45
3.2.5 Useful Tools.....	45
<b>Chapter 4 SETUP Menu Operation</b> .....	46
4.1 MEAS DISP Page.....	46

4.1.1 Impulse Voltage.....	48
4.1.2 Trigger Mode.....	48
4.1.3 Averaging Rate.....	49
4.1.4 Delay Time.....	49
4.1.5 Comparator Function ON/OFF.....	50
4.1.6 Voltage Adjustment ON/OFF.....	50
4.1.7 Standard Waveform Sample Mode.....	51
4.1.8 Waveform Display Mode.....	51
4.1.9 ON/OFF State for each comparison method.....	51
4.1.10 Start and End Positions for each comparison method.....	52
4.1.11 Difference limit for each comparison method.....	53
4.1.12 File Manager.....	53
4.1.13 Useful Tools.....	53
<b>Chapter 5 SYSTEM Menu Operation.....</b>	<b>54</b>
5.1 SYSTEM SETUP Page.....	54
5.1.1 LCD Contrast Adjustment.....	55
5.1.2 Alarm Mode for PASS.....	55
5.1.3 Alarm Mode for FAIL.....	56
5.1.4 PASS/FAIL Display ON/OFF.....	57
5.1.5 Keystroke Beeper ON/OFF.....	57
5.1.6 Display Language.....	57
5.1.7 Password Protection.....	57
5.1.8 Bus Operation Mode.....	58
5.1.9 GPIB Address.....	58
5.1.10 Test Mode Setup.....	58
5.1.11 File Manager.....	59
5.1.12 Useful Tools.....	59
<b>Chapter 6 Remote Operation.....</b>	<b>60</b>
6.1 RS-232 Interface Operation.....	60
6.1.1 RS-232 Connection.....	60
6.1.2 Serial Interface Specifications.....	62
6.1.3 Software Protocol.....	62
6.2 GPIB interface operation.....	62
6.2.1 GPIB Connection.....	62
6.2.2 GPIB Interface Capability.....	65
6.2.3 GPIB Addressing.....	65
6.2.4 General Bus Commands.....	65

6.3 Waveform Data Format.....	66
<b>Chapter 7 Handler Interface.....</b>	<b>67</b>
7.1 Basic Information.....	67
7.2 Electrical Characteristics.....	68
7.2.1 DC Isolated Outputs.....	68
7.2.2 DC Isolated Input.....	70
7.3. Setting Up the Handler Interface Board.....	71
<b>Chapter 8 SCPI Command Reference.....</b>	<b>72</b>
8.1 Command structure.....	72
8.2 Command Syntax.....	72
8.2.1 Notation Conventions and Definitions.....	72
8.2.2 Short-form Rules.....	73
8.2.3 Basic Rules of Command Structure.....	73
8.2.4 Multiple Command Rules.....	74
8.2.5 Command Path Rules.....	74
8.3 Command Reference.....	74
8.3.1 DISPlay Subsystem.....	75
8.3.2 COMParator Subsystem.....	77
8.3.3 Impulse VOLTage Subsystem.....	83
8.3.4 Sample RATE Subsystem.....	85
8.3.5 Standard WAVE Subsystem.....	86
8.3.6 STATistic Subsystem.....	88
8.3.7 TRIGger Subsystem.....	89
8.3.8 FETCh? Subsystem.....	90
8.3.9 MEASure Subsystem.....	93
8.3.10 ABORt Subsystem.....	94
8.3.11 Mass MEMory Subsystem.....	94
8.3.12 Common Commands.....	96
8.4 Error and Warning Messages.....	97
<b>Chapter 9 Specifications.....</b>	<b>98</b>
<b>Chapter 10 Warranty and Despatch Procedure.....</b>	<b>99</b>
10.1 Maintenance.....	99
10.1.1 Power Line Fuse Replacement.....	99
10.2 Despatch Procedure for Service.....	100
10.3 Warranty Conditions.....	101

## Impulse Winding Tester SME1203-1

### Chapter 1 General Information

Thanks very much for choosing and using our product. If you have any questions after reviewing this manual, please contact your local representative or call directly to our application engineers for further consultation.

#### 1.1 Product Introduction

Due to the influence of wire material, magnetic material, framework and manufacture technics, winding products such as transformers, motor windings may have defects of low insulation between winding layers, circles and leads. SME1203-1 Impulse Winding Tester, adopting the high-speed sampling technique, is a new generation test instrument for insulation performance of winding products.

SME1203-1 compares the standard waveform stored in the non-volatile memory with the current tested waveform. SME1203-1 provides the PASS or FAIL comparison result according to AREA SIZE, DIFFERENTIAL AREA, CORONA DISCHARGE or DIFFERENTIAL PHASE. With its strong functions, accurate comparison methods, easy operation and various Interfaces, SME1203-1 can provide a perfect test solution for most winding products.

#### 1.2 Incoming Inspection

The SME1203-1 was carefully inspected mechanically and electrically before shipment. After unpacking all items from the shipping carton, please check for any obvious signs of physical damage that may have occurred during transportation. Report any damage to the shipping agent immediately. Save the original packing carton for possible future reshipment. The following items are included with every Model SME1203-1 order:

- Model SME1203-1 Impulse Winding Tester
- High Voltage test clip leads
- Foot switch
- Power cable
- Two fuses of 1A
- SME1203-1 User's Manual

Verify that you have received all the items above when you get the tester. If anything is missing, please contact our representative or our sales office.

**NOTE: IEEE-488 interface, Scanner interface and USB adapter are optional.**

### **1.3 Power Requirements**

The SME1203-1 requires the following power source:

Voltage: 220 V

Frequency: 50 Hz

Power: 40 VA maximum

In accordance with international safety standards, this instrument is equipped with a three-wire power cable. When connected to an appropriate ac power outlet, this cable grounds the instrument frame.

The type of power cable shipped with each instrument depends on the country of destination.

***NOTE: For protection from electrical shock, the power cable ground must not be disconnected.***

***The power plug must be plugged into an outlet that provides a protective earth ground connection.***



## 1.4 Operation Environment

The SME1203-1 must be operated under within the following environment conditions, and sufficient space must be kept behind the SME1203-1 to avoid obstructing the air flow of the cooling fans.

Temperature: 0°C to 40°C

Humidity: less than 90% RH

## 1.5 Comparison Methods

### 1.5.1 Area Size Comparison

When comparison method is set to AREA SIZE, the area sizes of both standard waveform and the tested waveform are calculated between A and B. The percent deviation is the ratio of the area size difference to the area size of the standard waveform between A and B, expressed as a percentage.

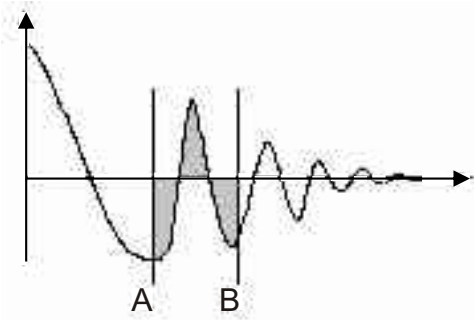


Figure 1-2 Area Size Comparison

The formula used to calculate the percent deviation is as follows.

$$\Delta\% = \left| \frac{\text{AREA}_{\text{TEST}} - \text{AREA}_{\text{STANDARD}}}{\text{AREA}_{\text{STANDARD}}} \right| \times 100\%$$

Where,  $\text{AREA}_{\text{TEST}}$  : The area size of tested waveform between A and B.

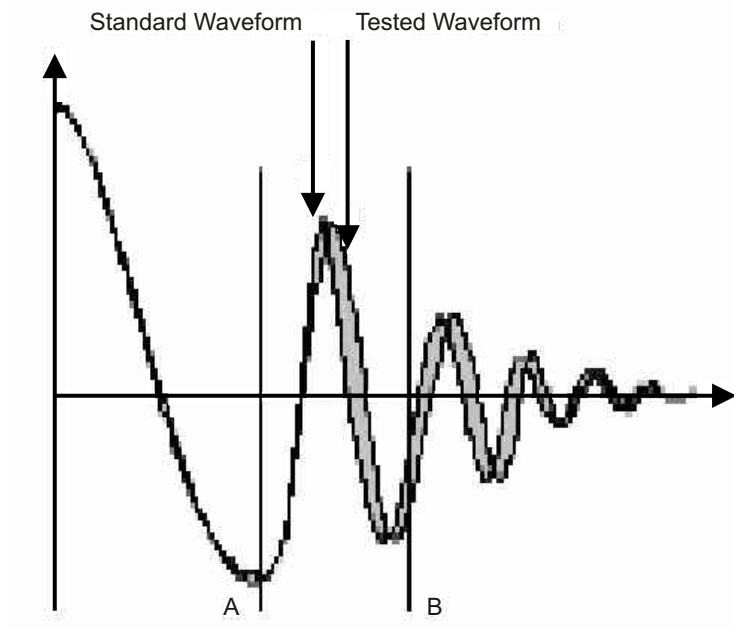
$\text{AREA}_{\text{STANDARD}}$  : The area size of standard waveform between A and B.

When  $\Delta\%$  is less than the difference limit, then the comparison result will be PASS. When  $\Delta\%$  is more than the difference limit, then the comparison result will be FAIL.

The area size of the waveform is nearly proportional to the energy loss in the winding. When a sample winding has a short circuit between layers, the short circuit area is reflected as an increase of energy loss.

### 1.5.2 Differential Area Comparison

When comparison method is set to Differential Area, the SME1203-1 calculates the area size of differential portion between the standard waveform and the tested waveform from A to B. The differential portion area size is indicated as the shaded part in Figure 1-3. The percent deviation is the ratio of the differential portion area size to the area size of the standard waveform between A and B, expressed as a percentage.



**Figure 1-3 Differential Area Comparison**

The formula used to calculate the percent deviation is as follows.

$$\Delta\% = \frac{|\text{AREA}_{\text{DIFFERENTIAL}}|}{|\text{AREA}_{\text{STANDARD}}|} \times 100\%$$

Where,  $\text{AREA}_{\text{DIFFERENTIAL}}$  : The differential area size between the tested waveform and the standard waveform from A to B.

$\text{AREA}_{\text{STANDARD}}$  : The area size of standard waveform between A and B.

When  $\Delta\%$  is less than the difference limit, then the comparison result will be PASS. When  $\Delta\%$  is more than the difference limit, then the comparison result will be FAIL.

The differential area size reflects the value of inductance and total energy loss. This method is especially effective when the inductance between the standard winding and the tested winding is

different and caused the main problem.

### 1.5.3 Corona Discharge Comparison

When comparison method is set to Corona Discharge, the SME1203-1 detects the high frequency energy of corona discharge from A to B as shown in Figure 1-4. When the corona evaluation value is less than the corona difference limit, then the comparison result will be PASS. When the corona evaluation value is more than the corona difference limit, then the comparison result will be FAIL. The corona evaluation value and difference limit are both expressed as an integer.

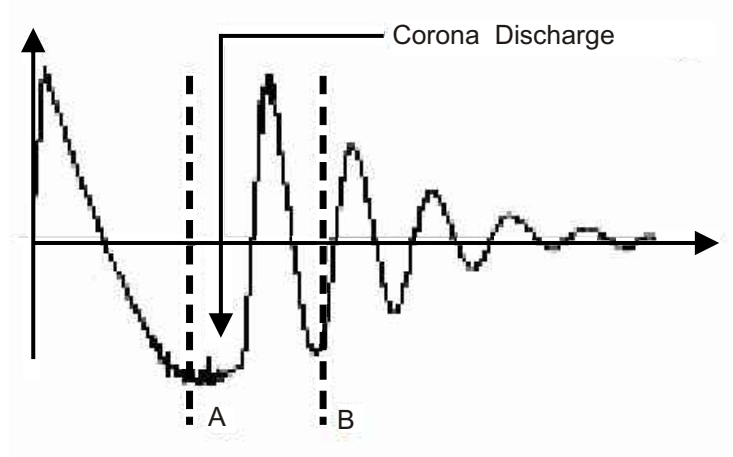
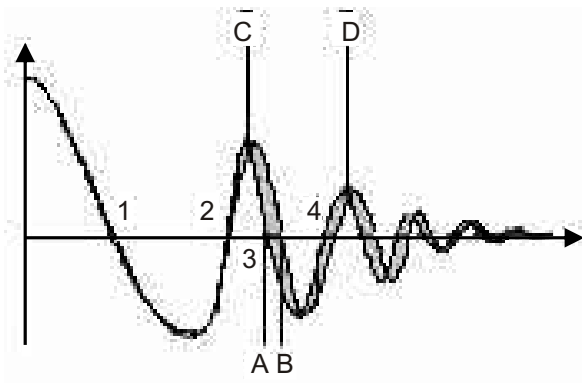


Figure1-4 Corona Discharge Comparison

### 1.5.4 Differential Phase Comparison

When comparison method is set to Differential Phase, you should choose a zero-crossing point from 2 to 10. For example the third zero-crossing point is selected as shown in Figure 1-5. The SME1203-1 measures the time difference ( $T_{AB}$ ) between the standard waveform and tested waveform at their third zero-crossing points and the period time ( $T_{CD}$ ) of the standard waveform. The percent deviation is the ratio of the time difference at the chosen zero-crossing points to the period time of the standard waveform, expressed as a percentage.



**Figure 1-5 Differential Phase Comparison**

The formula used to calculate the percent deviation is as follows.

$$\Delta\% = \frac{T_{AB}}{T_{CD}} \times 100\%$$

Where,  $T_{AB}$ : The time difference at the chosen zero-crossing points between the tested waveform and the standard waveform.

$T_{CD}$ : The period time of the standard waveform.

When  $\Delta\%$  is less than the percent difference limit, then the comparison result will be PASS. When  $\Delta\%$  is more than the percent difference limit, then the comparison result will be FAIL.

When there is no zero-crossing point in the tested waveform, the comparison result will be FAIL1.

When the period time is not available in the standard waveform, then the comparison result will be FAIL2.

# Chapter 2 SME1203-1 Overview

## 2.1 Front Panel Summary

The front panel of the SME1203-1 is shown in Figure 2-1. This figure includes some important abbreviated information that should be reviewed before operating the instrument.

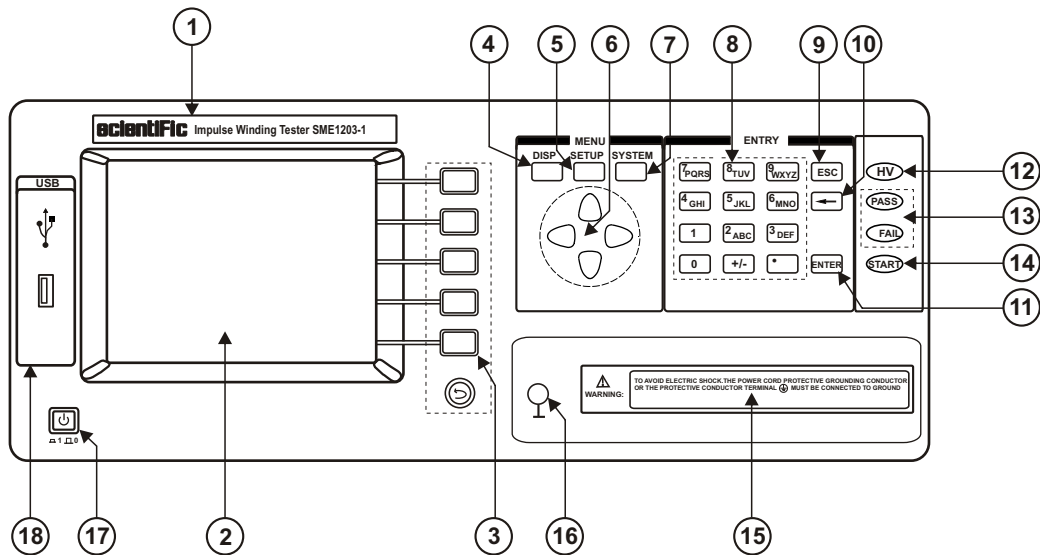


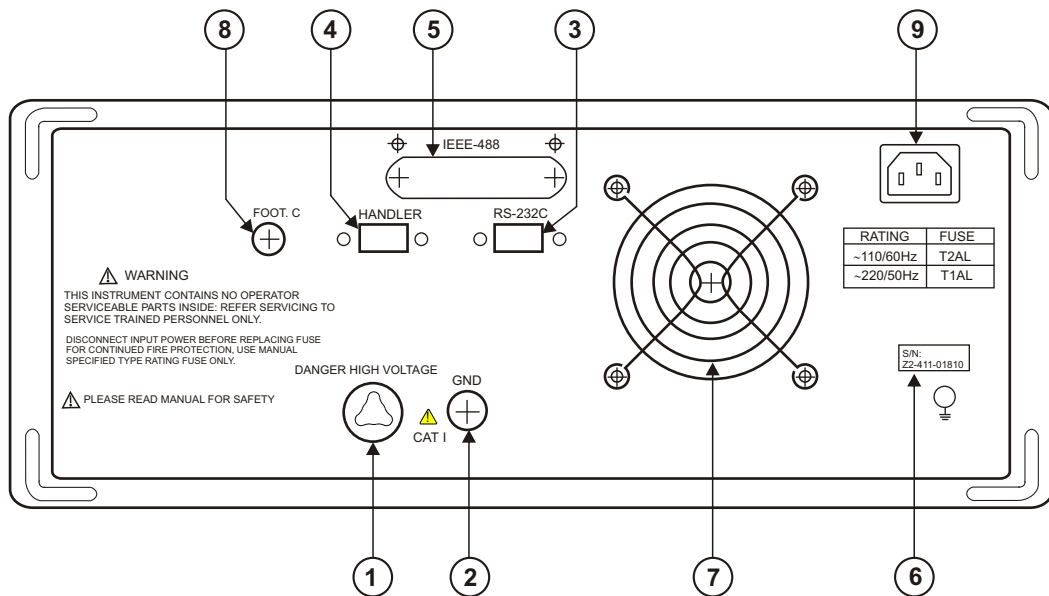
Figure 2-1 SME1203-1 Front Panel Overview

- 1) **Title and Model number**
- 2) **LCD:** 320 × 240 Large-Scale dot-matrix LCD displays measurement waveform, test conditions and system configurations, etc.
- 3) **SOFTKEY:** The five keys' functions are not fixed, they have different functions in different menus. Five softkeys are used to select control and parameter functions. Current function of each softkey is displayed along its left side.
- 4) **DISP menu key:** Press **DISP** menu key to enter the <MEAS DISP> page.
- 5) **SETUP menu key:** Press **SETUP** menu key to enter the <MEAS SETUP> page.
- 6) **CURSOR keys:** The CURSOR keys are used to move the field select cursor from field to field on the LCD display page. When the cursor is moved to a field, the field changes to an inverse video image of the original field.
- 7) **SYSTEM menu key:** Press **SYSTEM** menu key to enter the <SYSTEM SETUP> page.
- 8) **NUMBER keys:** The NUMBER keys are composed of the digits 0 to 9, a period ., a minus sign -. The number keys are used to enter numeric data into the SME1203-1.
- 9) **ESC:** For cancel the number or character.
- 10) **BACKSPACE key:** **BACKSPACE** key deletes one last character of the input value.

- 11) **ENTER key:** **ENTER** key terminates numeric input data and enters the displayed value on the data input line (bottom line of the LCD screen).
- 12) **High Voltage Indicator:** High Voltage Indicator indicates that the SME1203-1 is outputting dangerous impulse test voltage to the HV terminal on the rear panel.
- 13) **PASS , FAIL indicator:** Pass means qualified , fail means unqualified.
- 14) **START key :** Trigger the measurement , or stop testing in the process of testing.
- 15) **Warning Message:** This Warning Message calls attention to a procedure, practice , condition or the like, which, if not correctly performed or adhered to, could result in injury or death to personnel.
- 16) **FRAME Terminal:** This is the FRAME Terminal which is tied to the instrument's chassis and which can be used for measurements that require guarding.
- 17) **POWER :** Connect or cut off power.
- 18) **USB Interface:** An USB disk can be connected for standard waveforms and measurement conditions Storage.

## 2.2 Rear Panel Summary

The rear panel of SME1203-1 is shown in Figure 2-2. This section includes important information that should be reviewed before operating the instrument.



**Figure 2-2 SME1203-1 Rear Panel Overview**

- 1) **HV Test Terminal:** HV Test Terminal is connected to one end of the device under test and the high impulse voltage is outputted through the HV Test Terminal. Do not touch the HV Test Terminal or the device under test when the HV indicator is "ON" on the front panel.
- 2) **GND Test Terminal:** GND Test Terminal is connected to another end of the device under test.
- 3) **RS232C Interface:** RS232C Communication Interface can be connected to a computer for remote control and operation.
- 4) **HANDLER Interface:** This is the HANDLER Interface connector used when operation with an external handler to fully automate testing, comparing, and quality control data processing. Comparison results are outputted via the handler interface. You can also start or stop a test through the interface.
- 5) **IEEE488 Interface (option):** IEEE488 general purpose interface bus can be connected to a computer for remote control and operation.
- 6) **Sr. No:** Name Plate is used to provide the information of date, model, serial number.

- 7) **Cooling Fan:** Make sure that sufficient space must be kept around the SME1203-1 to avoid obstructing the air flow of the cooling fans.
- 8) **Foot Control:** A footswitch can be used to start a measurement instead of pressing the START key from the front panel.
- 9) **Line Input Receptacle:** AC power cord receptacle.



### 2.3 Display Area Definition

The display area on the LCD is divided into the areas shown in Figure 2-3.

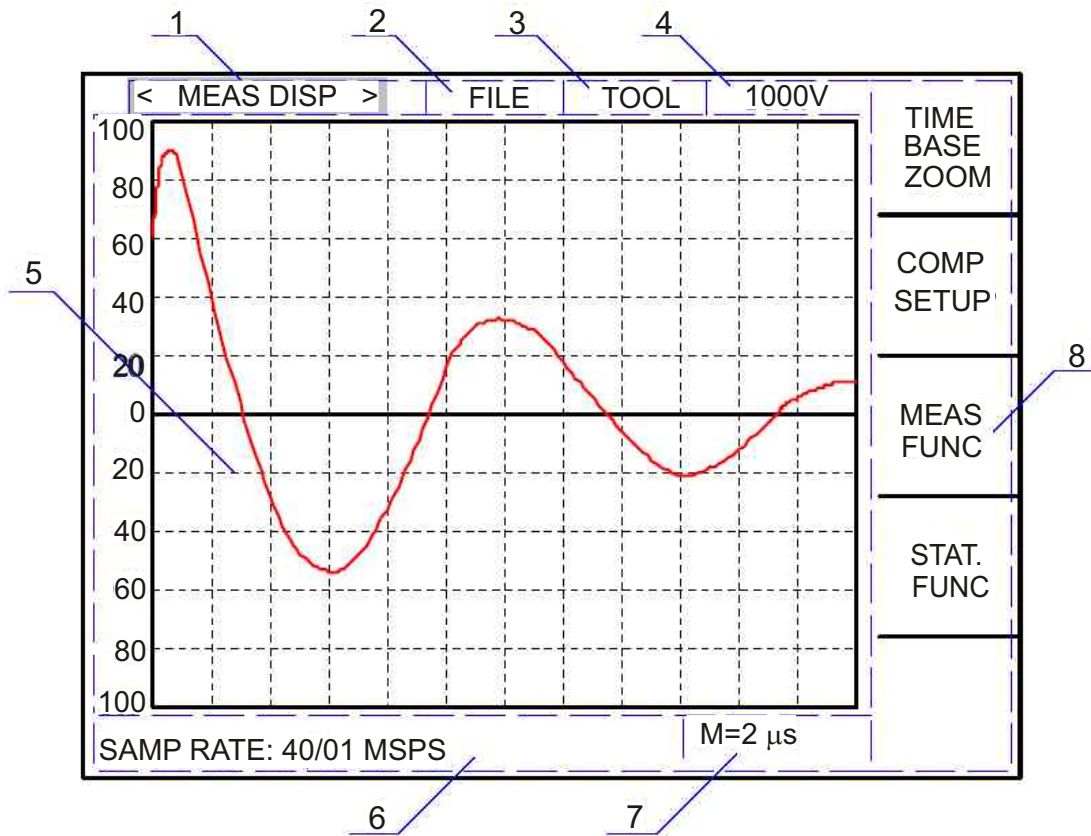


Figure 2-3 Display Area Definition

#### 1) Display Page Area

This is the display page area. This area identifies the current display page.

#### 2) FILE Field

When the cursor is set on the **FILE** field, FILE Manage function is available. Select FILE Manage function, common file functions which are not displayed on the display pages (for example, LOAD, SAVE, DELETE, COPY functions) are made available.

#### 3) TOOL Field

Some special controls which cannot be set on a display page's fields are made available: OPEN LOAD, CLOSE LOAD, CLOSE GRID and LOCK KEY.

#### 4) Impulse Voltage Field

Move the cursor to the Impulse Voltage Field to set the test impulse voltage.

### 5) **Waveform Display Area**

This area is where tested waveforms, standard waveforms and comparison results are displayed.

- The GO/NG comparison results for 4 different comparison modes are displayed ON the top right corner of the Display Area.
- The calculation results for 4 different comparison modes are displayed on the bottom right corner of the Display Area.
- The measurement results of voltage, time, frequency and current file information are displayed on the bottom left corner of the Display Area.

### 6) **System Message and Data Input Line**

This line is where system messages, comments, error messages and numeric input data are displayed.

### 7) **Sweep Speed Monitor**

The time per division is displayed in this area.

### 8) **Soft key Area**

This area is reserved for soft key labels. The soft keys displayed correspond to the field at the cursor's position on the LCD.

## 2.4 **Basic Operation**

The SME1203-1 basic operation is described in the following paragraphs.

- 1) Display the desired display page using both the MENU keys (**DISP**, **SETUP**, and **SYSTEM**) and the softkeys.
- 2) Move the cursor to the desired field using the CURSOR arrow keys. The cursor will be an inverse video marker, and the field is the area to which you can set the cursor.
- 3) The soft keys corresponding to the field pointed to by the cursor will be displayed. Select and press a soft key.
- 4) The numeric entry keys and **ENTER** key are used to enter numeric data. When one of the numeric entry keys is pressed to input an impulse voltage on the <MEAS DISP> page, the softkeys will change to the available unit softkeys. You can use these unit softkeys instead of **ENTER**. When **ENTER** is used, the numeric data is entered with V as the default unit.

Here is an operation example to set the trigger mode to the EXTERNAL mode.

- 1) Press **SETUP** menu key, <MEAS SETUP> page will be displayed as shown in Figure 2-4.

< MEAS SETUP >		FILE	TOOL
IMP VOLT	: 1000V	TRIG MODE	: MAN
AVG TIMES	: 1	DELAY	: 1.0s
COMPARATOR	: ON	VOLT ADJ	: ON
SWAVE SAMP	: ONE CYCLE		
WAVE DISP	: ALL ON		

STAT	METHOD	POSIT	DIFF
✓	AREA SIZE	560 – 640	2.0%
✓	DIFF ZONE	660 – 800	2.0%
✓	CORONA	560 – 720	2
✓	PHASE DIFF	2	2.0%

Table: comparison terms

☺ Welcome to use

**Figure 2-4 MEAS SETUP Page**

- 2) Press **↓** key to move the cursor to the **IMP VOLT** field, the following page will be displayed as shown in figure 2-5.

< MEAS SETUP >		FILE	TOOL
IMP VOLT	: 1000V	TRIG MODE	: MAN
AVG TIMES	: 1	DELAY	: 1.0s
COMPARATOR	: ON	VOLT ADJ	: ON
SWAVE SAMP	: ONE CYCLE		
WAVE DISP	: ALL ON		

STAT	METHOD	POSIT	DIFF
✓	AREA SIZE	560 – 640	2.0%
✓	DIFF ZONE	660 – 800	2.0%
✓	CORONA	560 – 720	2
✓	PHASE DIFF	2	2.0%

Table: comparison terms

☺ Input data or use ↑, ↓, ←, → select

**Figure 2-5 IMP VOLT Field on MEAS SETUP Page**

- 3) Press  key to move the cursor to the **TRIG MODE** field, the following page will be displayed as shown in figure 2-6.

< MEAS SETUP >		FILE	TOOL
IMP VOLT	: 1000V	TRIG MODE	: MAN MAN
AVG TIMES	: 1	DELAY	: 1.0s
COMPARATOR	: ON	VOLT ADJ	: ON
SWAVE SAMP	: ONE CYCLE		EXT
WAVE DISP	: ALL ON		
STAT	METHOD	POSIT	DIFF
✓	AREA SIZE	560 – 640	2.0%
✓	DIFF ZONE	660 – 800	2.0%
✓	CORONA	560 – 720	2
✓	PHASE DIFF	2	2.0%
			INT
Table: comparison terms			
☺ Use softkey to select			

**Figure 2-6 TRIG MODE Field on MEAS SETUP Page**

- 4) Press soft key EXT to set the trigger mode to EXTERNAL mode as shown in Figure 2-7.

< MEAS SETUP >		FILE	TOOL
IMP VOLT	: 1000V	TRIG MODE	: EXT MAN
AVG TIMES	: 1	DELAY	: 1.0s
COMPARATOR	: ON	VOLT ADJ	: ON
SWAVE SAMP	: ONE CYCLE		EXT
WAVE DISP	: ALL ON		
STAT	METHOD	POSIT	DIFF
✓	AREA SIZE	560 – 640	2.0%
✓	DIFF ZONE	660 – 800	2.0%
✓	CORONA	560 – 720	2
✓	PHASE DIFF	2	2.0%
			INT
Table: comparison terms			
☺ Use softkey to select			

**Figure 2-7 TRIG MODE Is Set to EXT Mode**

# Chapter 3 DISP Menu Operation

## 3.1 MEAS DISP Page

When you press **DISP** menu key, the <MEAS DISP> page will be displayed. On this page, the captured waveforms, voltage, time, and frequency measurement results are displayed, and the following measurement controls can be set from this page.

- Impulse Voltage
- Sample Rate (**SAMP RATE**)
- File Manage (**FILE**)
- Tools (**TOOL**)

The available fields and the softkeys which correspond to the fields on this page are shown in Figure 3-1 and Figure 3-2 respectively.

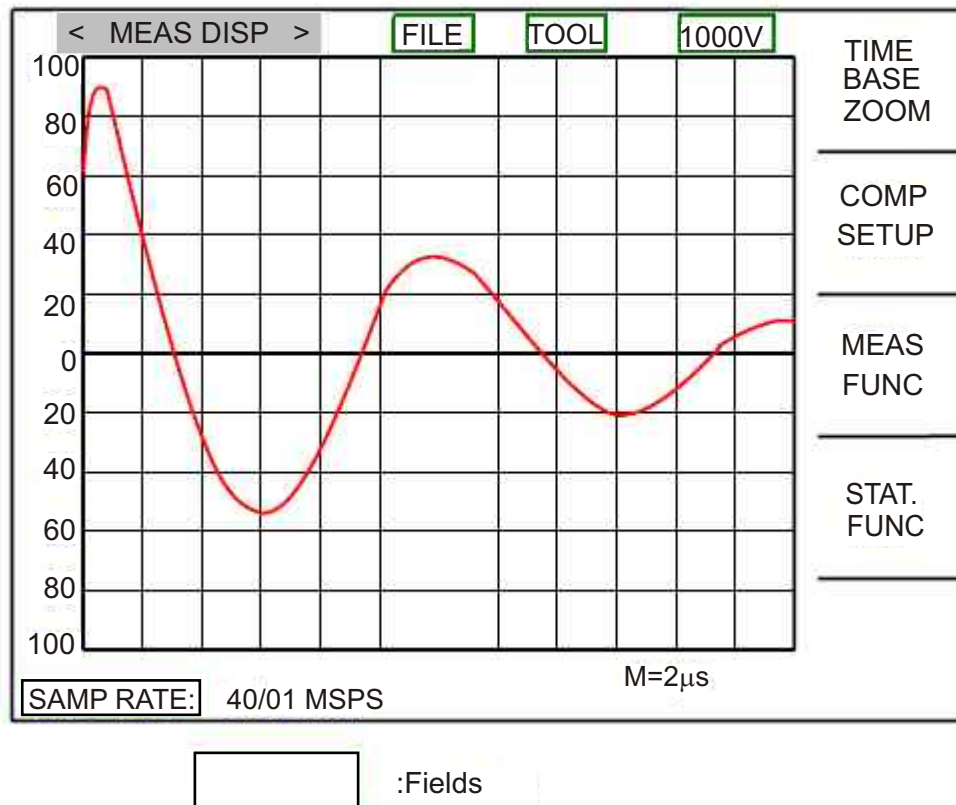
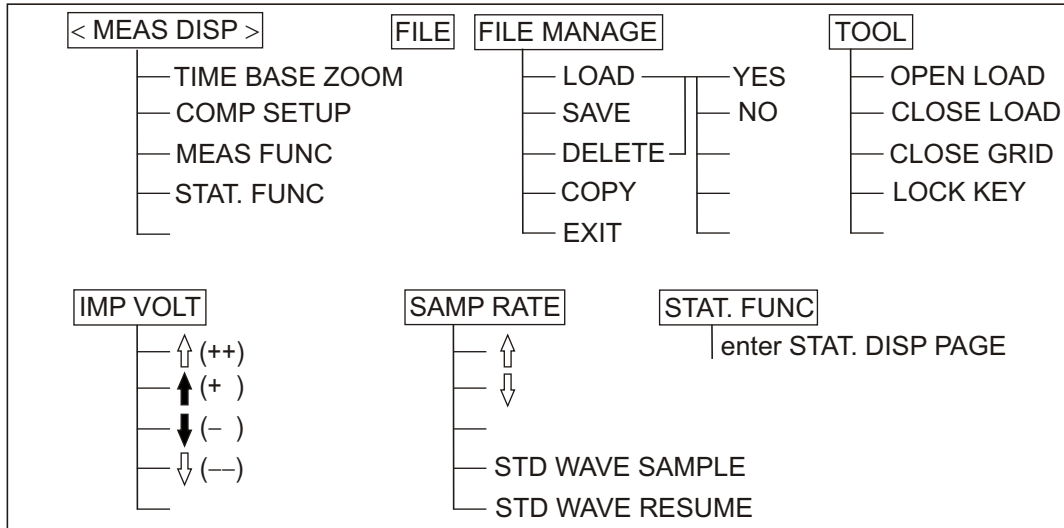


Figure 3-1 Available Fields on the MEAS DISP Page



**Figure 3-2 Available Softkeys on the MEAS DISP Page (1/2)**

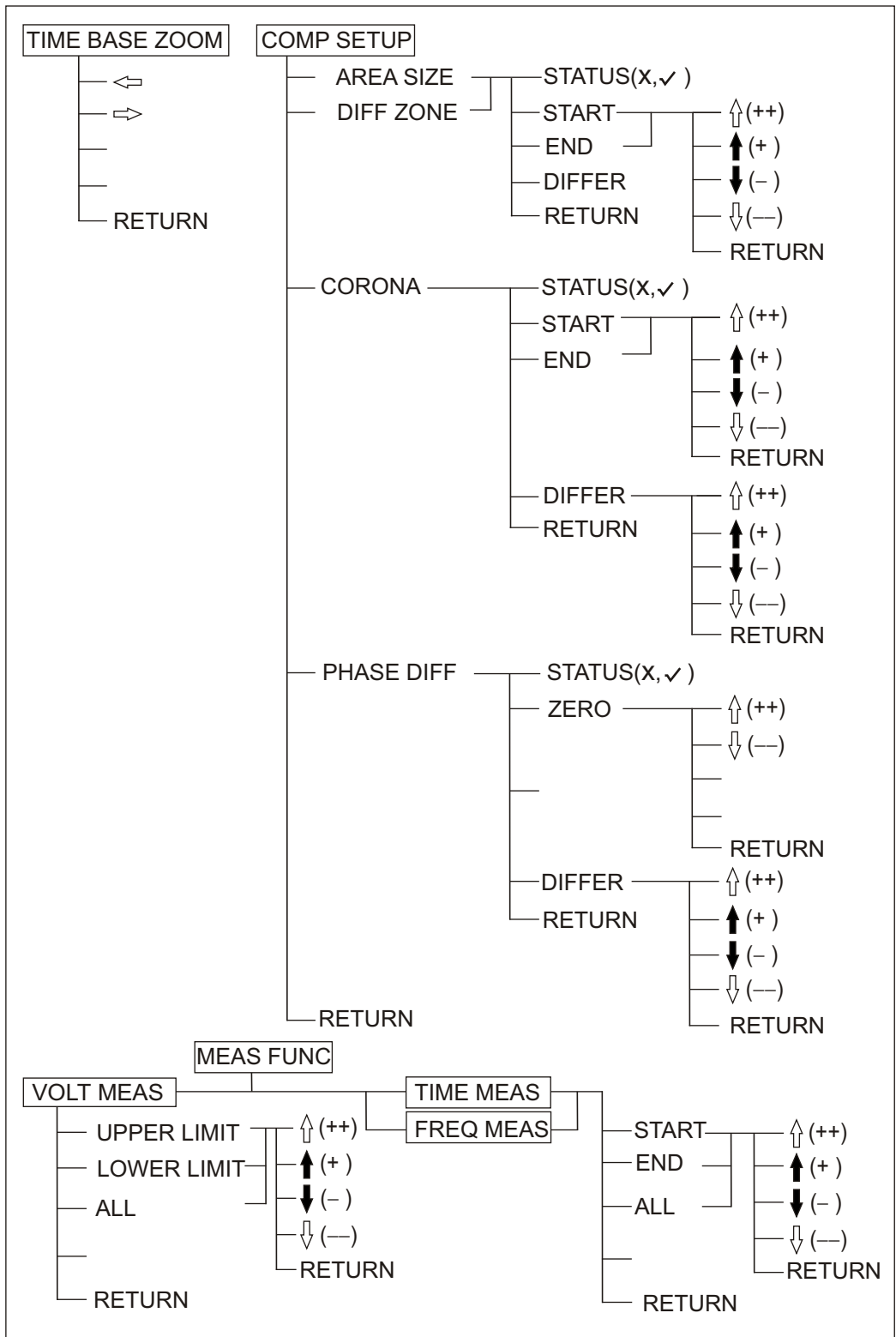


Figure 3-2 Available Softkeys on the MEAS DISP Page (2/2)

### 3.1.1 TIME BASE ZOOM Function

TIME BASE ZOOM function can be used to expand or contract the captured waveform displayed on the LCD. So you can observe the waveform clearer. Three kinds of time per horizontal division are available: 256  $\mu\text{s}/\text{div}$ , 128  $\mu\text{s}/\text{div}$  and 64  $\mu\text{s}/\text{div}$ .

Perform the following steps to expand or contract the waveforms.

- 1) Press **DISP** menu key to enter the <MEAS DISP> page, the following softkeys will be displayed.
  - TIME BASE ZOOM
  - COMP SETUP
  - MEAS FUNC
  - STAT. FUNC
- 2) Press TIME BASE ZOOM softkey to adjust the displayed waveform, the following softkeys will be displayed.
  - $\Rightarrow$
  - Press  $\Rightarrow$  to expand the waveform with a high sweep speed.
  - $\Leftarrow$
  - Press  $\Leftarrow$  to contract the waveform with a low sweep speed.
  - RETURN
  - Press RETURN to return back to the former display page.

### 3.1.2 Comparator Setup

SME1203-1 provides four kinds of detection methods as follows.






- Area Size Comparison
- Differential Area Comparison
- Corona Discharge Comparison
- Differential Phase Comparison

Perform the following steps to set the comparison range and percent difference for Area Size Comparison method.

- 1) Press **DISP** menu key to enter the <MEAS DISP> page, the following softkeys will be displayed.
  - TIME BASE ZOOM
  - COMP SETUP
  - MEAS FUNC
  - STAT. FUNC
- 2) Press COMP SETUP softkey to set the comparison parameters, the following softkeys will be displayed.
  - AREA SIZE
  - DIFF ZONE
  - CORONA
  - PHASE DIFF
  - RETURN
- 3) Press AREA SIZE softkey to set the comparison range and percent difference for Area Size comparison method. The following softkeys will be displayed.
  - STATUS
  - START
  - END
  - DIFFER



- RETURN
- 4) Press STATUS softkey to toggle the AREA SIZE comparator status between ✓ (ON) and × (OFF).
  - 5) Press START softkey to set the start position for AREA SIZE comparison. The start position will be displayed on the bottom left corner of the LCD. Use the following displayed softkeys to set the start position between 0 and the end position.
    - ⇨ (++)  
This softkey is the coarse increment softkey used to increase the start position by twenty dots.
    - ➡ (+)  
This softkey is the fine increment softkey used to increase the start position by one dot.
    - ← (-)  
This softkey is the fine decrement softkey used to decrease the start position by one dot.
    - ⇩ (--)  
This softkey is the coarse decrement softkey used to decrease the start position by twenty dots.
    - RETURN  
Press RETURN key to terminate the start position setup and return back to the former display page.
  - 6) Press END softkey to set the end position for AREA SIZE comparison. The end position will be displayed on the bottom left corner of the LCD. Use the following displayed softkeys to set the end position between start position and 960.
    - ⇨ (++)  
This softkey is the coarse increment softkey used to increase the end position by twenty dots.
    - ➡ (+)  
This softkey is the fine increment softkey used to increase the start position by one dot.
    - ← (-)  
This softkey is the fine decrement softkey used to decrease the start position by one dot.
    - ⇩ (--)  
This softkey is the coarse decrement softkey used to decrease the start position by twenty dots.
    - RETURN  
Press RETURN key to terminate the end position setup and return back to the former display page.
  - 7) Press DIFFER softkey to set the percent difference for AREA SIZE comparison. The percent difference will be displayed on the bottom left corner of the LCD. Use the following displayed softkeys to input the difference value from 0.0% to 99.9%.
    - ↑ (++)  
This softkey is the coarse increment softkey used to increase the difference by 1%.
    - ⬆ (+)  
This softkey is the fine increment softkey used to increase the difference by 0.1%.
    - ↓ (-)  
This softkey is the fine decrement softkey used to decrease the difference by 0.1%.

-  (--)  
This softkey is the coarse decrement softkey used to decrease the difference by 1%.
  - RETURN  
Press RETURN key to terminate the percent difference setup and return back to the former display page.
- 8) Press RETURN to return back to the former display page.
- Perform the following steps to set the comparison range and percent difference for Differential Area comparison method.
- 1) Press **DISP** menu key to enter the <MEAS DISP> page, the following softkeys will be displayed.
    - TIME BASE ZOOM
    - COMP SETUP
    - MEAS FUNC
    - STAT. FUNC
  - 2) Press COMP SETUP softkey to set the comparison parameters, the following softkeys will be displayed.
    - AREA SIZE
    - DIFF ZONE
    - CORONA
    - PHASE DIFF
    - RETURN
  - 3) Press DIFF ZONE softkey to set the comparison range and percent difference for Difference Area comparison method. The following softkeys will be displayed.
    - STATUS
    - START
    - END
    - DIFFER
    - RETURN
  - 4) Press STATUS softkey to toggle the DIFF ZONE comparator status between ✓ (ON) and × (OFF).
  - 5) Press START softkey to set the start position for DIFF ZONE comparison. The start position will be displayed on the bottom left corner of the LCD. Use the following displayed softkeys to set the start position between 0 and the end position.
    -  (++)  
This softkey is the coarse increment softkey used to increase the start position by twenty dots.
    -  (+)  
This softkey is the fine increment softkey used to increase the start position by one dot.
    -  (-)  
This softkey is the fine decrement softkey used to decrease the start position by one dot.
    -  (--)  
This softkey is the coarse decrement softkey used to decrease the start position by twenty dots.

- RETURN  
Press RETURN key to terminate the start position setup and return back to the former display page.
- 6) Press END softkey to set the end position for DIFF ZONE comparison. The end position will be displayed on the bottom left corner of the LCD. Use the following displayed softkeys to set the end position between start position and 960.
- $\Rightarrow$  (++)  
This softkey is the coarse increment softkey used to increase the end position by twenty dots.
  - $\rightarrow$  (+)  
This softkey is the fine increment softkey used to increase the start position by one dot.
  - $\leftarrow$  (-)  
This softkey is the fine decrement softkey used to decrease the start position by one dot.
  - $\Leftarrow$  (--)  
This softkey is the coarse decrement softkey used to decrease the start position by twenty dots.
  - RETURN  
Press RETURN key to terminate the start position setup and return back to the former display page.
- 7) Press DIFFER softkey to set the percent difference for DIFF ZONE comparison. The percent difference will be displayed on the bottom left corner of the LCD. Use the following displayed softkeys to input the difference value from 0.0% to 99.9%.
- $\Uparrow$  (++)  
This softkey is the coarse increment softkey used to increase the difference by 1%.
  - $\uparrow$  (+)  
This softkey is the fine increment softkey used to increase the difference by 0.1%.
  - $\Downarrow$  (-)  
This softkey is the fine decrement softkey used to decrease the difference by 0.1%.
  - $\Downarrow$  (--)  
This softkey is the coarse decrement softkey used to decrease the difference by 1%.
  - RETURN  
Press RETURN key to terminate the percent difference setup and return back to the former display page.
- 8) Press RETURN to return back to the former display page.  
Perform the following steps to set the comparison range and difference for Corona Discharge comparison method.
- 1) Press **DISP** menu key to enter the <MEAS DISP> page, the following softkeys will be displayed.
- TIME BASE ZOOM
  - COMP SETUP
  - MEAS FUNC
  - STAT. FUNC
- 2) Press COMP SETUP softkey to set the comparison parameters, the following softkeys will be displayed.

- AREA SIZE
  - DIFF ZONE
  - CORONA
  - PHASE DIFF
  - RETURN
- 3) Press CORONA softkey to set the comparison range and difference for Corona Discharge Comparison method. The following softkeys will be displayed.
- STATUS
  - START
  - END
  - DIFFER
  - RETURN
- 4) Press STATUS softkey to toggle the CORONA comparator status between ✓ (ON) and × (OFF).
- 5) Press START softkey to set the start position for CORONA comparison. The start position will be displayed on the bottom left corner of the LCD. Use the following displayed softkeys to set the start position between 0 and the end position.
- ⇨ (++)  
This softkey is the coarse increment softkey used to increase the start position by twenty dots.
  - ➡ (+)  
This softkey is the fine increment softkey used to increase the start position by one dot.
  - ← (-)  
This softkey is the fine decrement softkey used to decrease the start position by one dot.
  - ⇨ (- -)  
This softkey is the coarse decrement softkey used to decrease the start position by twenty dots.
  - RETURN  
Press RETURN key to terminate the start position setup and return back to the former display page.
- 6) Press END softkey to set the end position for CORONA comparison. The end position will be displayed on the bottom left corner of the LCD. Use the following displayed softkeys to set the end position between start position and 960.
- ⇨ (++)  
This softkey is the coarse increment softkey used to increase the end position by twenty dots.
  - ➡ (+)  
This softkey is the fine increment softkey used to increase the start position by one dot.
  - ← (-)  
This softkey is the fine decrement softkey used to decrease the start position by one dot.
  - ⇨ (- -)  
This softkey is the coarse decrement softkey used to decrease the start position by twenty

dots.

- RETURN

Press RETURN key to terminate the end position setup and return back to the former display page.

- 7) Press DIFFER softkey to set the difference for CORONA comparison. The difference will be displayed on the bottom left corner of the LCD. Use the following displayed softkeys to input the difference value from 0 to 999.

- $\uparrow$  (++)

This softkey is the coarse increment softkey used to increase the difference by 10.

- $\uparrow$  (+)

This softkey is the fine increment softkey used to increase the difference by 1.

- $\downarrow$  (-)

This softkey is the fine decrement softkey used to decrease the difference by 1.

- $\downarrow$  (- -)

This softkey is the coarse decrement softkey used to decrease the difference by 10.

- RETURN

Press RETURN key to terminate the difference setup and return back to the former display page.

- 8) Press RETURN to return back to the former display page.

Perform the following steps to set the comparison range and percent difference for Differential Phase Comparison method.

- 1) Press **DISP** menu key to enter the <MEAS DISP> page, the following softkeys will be displayed.

- TIME BASE ZOOM

- COMP SETUP

- MEAS FUNC

- STAT. FUNC

- 2) Press COMP SETUP softkey to set the comparison parameters, the following softkeys will be displayed.

- AREA SIZE

- DIFF ZONE

- CORONA

- PHASE DIFF

- RETURN

- 3) Press PHASE DIFF softkey to select the zero-crossing position and percent difference for Differential Phase Comparison method. The following softkeys will be displayed.

- STATUS

- ZERO

- DIFFER

- RETURN

- 4) Press STATUS softkey to toggle the PHASE DIFF comparator status between  $\checkmark$  (ON) and  $\times$  (OFF).

- 5) Press ZERO softkey to select the zero-crossing position from 2 to 10 for Differential Phase Comparison. The current position will be displayed on the bottom left corner of the LCD. The following softkeys will be displayed.
  - $\uparrow$  (+)  
This softkey is used to increase the zero-crossing position.
  - $\downarrow$  (-)  
This softkey is used to decrease the zero-crossing position.
  - RETURN  
Press RETURN key to terminate the zero-crossing position selection and return back to the former display page.
- 6) Press DIFFER softkey to set the percent difference for PHASE DIFF comparison. The percent difference will be displayed on the bottom left corner of the LCD. Use the following displayed softkeys to input the difference value from 0.0% to 99.9%.
  - $\uparrow$  (++)  
This softkey is the coarse increment softkey used to increase the difference by 1%.
  - $\uparrow$  (+)  
This softkey is the fine increment softkey used to increase the difference by 0.1%.
  - $\downarrow$  (-)  
This softkey is the fine decrement softkey used to decrease the difference by 0.1%.
  - $\downarrow$  (--)  
This softkey is the coarse decrement softkey used to decrease the difference by 1%.
  - RETURN  
Press RETURN key to terminate the percent difference setup and return back to the former display page.
- 7) Press RETURN to return back to the former display page.

### 3.1.3 Measurement Function

SME1203-1 provides three kinds of measurement functions:









- Voltage Measurement Function (VOLT MEAS)
- Time Measurement Function (TIME MEAS)
- Frequency Measurement Function (FREQ MEAS)

#### 3.1.3.1 Voltage Measurement Function

Voltage Measurement Function is used to measure the voltage value between the upper and lower cursors. The upper and lower cursors are horizontal dash lines.

Perform the following steps to measure the voltage.

- 1) Press  $\overline{\text{DISP}}$  menu key to enter the <MEAS DISP> page, the following softkeys will be displayed.
  - TIME BASE ZOOM
  - COMP SETUP
  - MEAS FUNC
  - STAT. FUNC
- 2) Press MEAS FUNC softkey to select the measurement functions. The following softkeys will be displayed.
  - VOLT MEAS

- TIME MEAS
  - FREQ MEAS
  - RETURN
- 3) Press VOLT MEAS softkey to select the voltage measurement function. The upper and lower cursors will be displayed on the LCD screen, and the current measurement voltage “ΔV” will also be displayed on the bottom left corner of the LCD. The following softkeys will be displayed.
- UPPER LIMIT
  - LOWER LIMIT
  - ALL
  - RETURN
- 4) Press UPPER LIMIT softkey to set the position of the upper limit cursor above the lower limit cursor position and below the top edge of the waveform display area.
-  (++)  
This softkey is the coarse vertical adjustment softkey used to move the cursor up by 10 dots each time you press this softkey.
  -  (+ )  
This softkey is the fine vertical adjustment softkey used to move the cursor up by 1 dot each time you press this softkey.
  -  (- )  
This softkey is the fine vertical adjustment softkey used to move the cursor down by 1 dot each time you press this softkey.
  -  (- -)  
This softkey is the coarse vertical adjustment softkey used to move the cursor down by 10 dots each time you press this softkey.
  - RETURN  
Press RETURN to terminate the adjustment of the upper cursor position and return back to the former display page.
- 5) Press LOWER LIMIT softkey to set the position of the lower limit cursor below the upper limit cursor position and above the bottom of the waveform display area.
-  (++)  
This softkey is the coarse vertical adjustment softkey used to move the cursor up by 10 dots each time you press this softkey.
  -  (+ )  
This softkey is the fine vertical adjustment softkey used to move the cursor up by 1 dot each time you press this softkey.
  -  (- )  
This softkey is the fine vertical adjustment softkey used to move the cursor down by 1 dot each time you press this softkey.
  -  (- -)  
This softkey is the coarse vertical adjustment softkey used to move the cursor down by 10 dots each time you press this softkey.
  - RETURN

Press RETURN to terminate the adjustment of both the cursors' position and return back to the former display page.

- 6) Press ALL softkey to move both the lower and upper limit cursors at the same time between the top and the bottom edge of the waveform display area.
  - $\uparrow$  (++)  
This softkey is the coarse vertical adjustment softkey used to move both the cursors up by 10 dots each time you press this softkey.
  - $\uparrow$  (+ )  
This softkey is the fine vertical adjustment softkey used to move both the cursors up by 1 dot each time you press this softkey.
  - $\downarrow$  (- )  
This softkey is the fine vertical adjustment softkey used to move both the cursors down by 1 dot each time you press this softkey.
  - $\downarrow$  (- -)  
This softkey is the coarse vertical adjustment softkey used to move both the cursors down by 10 dots each time you press this softkey.
  - RETURN  
Press RETURN to terminate the adjustment of both the cursors' position and return back to the former display page.
- 7) Press RETURN to terminate the measurement function and return back to the former display page.

### 3.1.3.2 Time Measurement Function

Time Measurement Function is used to measure the time value between the start and end cursors. The start and end cursors are vertical dash lines.

Perform the following steps to measure the time.

- 1) Press **DISP** menu key to enter the <MEAS DISP> page, the following softkeys will be displayed.
  - TIME BASE ZOOM
  - COMP SETUP
  - MEAS FUNC
  - STAT. FUNC
- 2) Press MEAS FUNC softkey to select the measurement functions. The following softkeys will be displayed.
  - VOLT MEAS
  - TIME MEAS
  - FREQ MEAS
  - RETURN
- 3) Press TIME MEAS softkey to select the time measurement function. The start and end cursors will be displayed on the LCD screen, and the current measurement time "ΔT" will also be displayed on the bottom left corner of the LCD. The following softkeys will be displayed.
  - START
  - END
  - ALL
  - RETURN
- 4) Press START softkey to set the position of the start cursor between the left edge of the waveform



display area and the end cursor position.

- ⇨ (++)  
This softkey is the coarse horizontal adjustment softkey used to move the cursor right by 10 dots each time you press this softkey.
  - ➡ (+)  
This softkey is the fine horizontal adjustment softkey used to move the cursor right by 1 dot each time you press this softkey.
  - ← (-)  
This softkey is the fine horizontal adjustment softkey used to move the cursor left by 1 dot each time you press this softkey.
  - ⇩ (--)  
This softkey is the coarse horizontal adjustment softkey used to move the cursor left by 10 dots each time you press this softkey.
  - RETURN  
Press RETURN to terminate the adjustment of the start cursor position and return back to the former display page.
- 5) Press END softkey to set the position of the end cursor between the start cursor position and the right edge of the waveform display area.
- ⇨ (++)  
This softkey is the coarse horizontal adjustment softkey used to move the cursor right by 10 dots each time you press this softkey.
  - ➡ (+)  
This softkey is the fine horizontal adjustment softkey used to move the cursor right by 1 dot each time you press this softkey.
  - ← (-)  
This softkey is the fine horizontal adjustment softkey used to move the cursor left by 1 dot each time you press this softkey.
  - ⇩ (--)  
This softkey is the coarse horizontal adjustment softkey used to move the cursor each time you press this softkey.
  - RETURN  
Press RETURN to terminate the adjustment of the end cursor position and return back to the former display page.
- 6) Press ALL softkey to move both the start and end cursors at the same time between the left and right edge of the waveform display area.
- ⇨ (++)  
This softkey is the coarse horizontal adjustment softkey used to move the both cursors right by 10 dots each time you press this softkey.
  - ➡ (+)  
This softkey is the fine horizontal adjustment softkey used to move the both cursors right by 1 dot each time you press this softkey.
  - ← (-)  
This softkey is the fine horizontal adjustment softkey used to move the both cursors left by 1

dot each time you press this softkey.

- ⇐ (- -)

This softkey is the coarse horizontal adjustment softkey used to move the both cursor left by 10 dots each time you press this softkey.

- RETURN

Press RETURN to terminate the adjustment of the both cursors' position and return back to the former display page.

- 7) Press RETURN to terminate the measurement function and return back to the former display page.

### 3.1.3.3 Frequency Measurement Function

Frequency Measurement Function is used to measure the frequency value between the start and end cursors. The start and end cursors are vertical dash lines.

Perform the following steps to measure the frequency.

- 1) Press **DISP** menu key to enter the <MEAS DISP> page, the following softkeys will be displayed.

- TIME BASE ZOOM
- COMP SETUP
- MEAS FUNC
- STAT. FUNC

- 2) Press MEAS FUNC softkey to select the measurement functions. The following softkeys will be displayed.

- VOLT MEAS
- TIME MEAS
- FREQ MEAS
- RETURN

- 3) Press FREQ MEAS softkey to select the frequency measurement function. The start and end cursors will be displayed on the LCD screen, and the current measurement frequency "1/ΔT" will also be displayed on the bottom left corner of the LCD. The following softkeys will be displayed.

- START
- END
- ALL
- RETURN

- 4) Press START softkey to set the position of the start cursor between the left edge of the waveform display area and the end cursor position.

- ⇒ (++)










This softkey is the coarse horizontal adjustment softkey used to move the cursor right by 10 dots each time you press this softkey.

- ➡ (+)

This softkey is the fine horizontal adjustment softkey used to move the cursor right by 1 dot each time you press this softkey.

- ← (-)

This softkey is the fine horizontal adjustment softkey used to move the cursor left by 1 dot each time you press this softkey.

-  ( - - )  
This softkey is the coarse horizontal adjustment softkey used to move the cursor left by 10 dots each time you press this softkey.
  - RETURN  
Press RETURN to terminate the adjustment of the start cursor position and return back to the former display page.
- 5) Press END softkey to set the position of the end cursor between the start cursor position and the right edge of the waveform display area.
-  ( ++ )  
This softkey is the coarse horizontal adjustment softkey used to move the cursor right by 10 dots each time you press this softkey.
  -  ( + )  
This softkey is the fine horizontal adjustment softkey used to move the cursor right by 1 dot each time you press this softkey.
  -  ( - )  
This softkey is the fine horizontal adjustment softkey used to move the cursor left by 1 dot each time you press this softkey.
  -  ( - - )  
This softkey is the coarse horizontal adjustment softkey used to move the cursor left by 10 dots each time you press this softkey.
  - RETURN  
Press RETURN to terminate the adjustment of the end cursor position and return back to the former display page.
- 6) Press ALL softkey to move both the start and end cursors at the same time between the left and right edge of the waveform display area.
-  ( ++ )  
This softkey is the coarse horizontal adjustment softkey used to move the both cursors right by 10 dots each time you press this softkey.
  -  ( + )  
This softkey is the fine horizontal adjustment softkey used to move the both cursors right by 1 dot each time you press this softkey.
  -  ( - )  
This softkey is the fine horizontal adjustment softkey used to move the both cursors left by 1 dot each time you press this softkey.
  -  ( - - )  
This softkey is the coarse horizontal adjustment softkey used to move the both cursor left by 10 dots each time you press this softkey.
  - RETURN  
Press RETURN to terminate the adjustment of the both cursors' position and return back to the former display page.
- 7) Press RETURN to terminate the measurement function and return back to the former display page.

### 3.1.4 File Manager

SME1203-1 uses the internal non-volatile memory for storing and retrieving a maximum of 60 sets of instrument control settings, comparison parameters, statistic data and standard waveform. An USB disk can also be used to store and retrieve another 500 files.

The following data will be stored in the non-volatile memory as one file.

- Standard waveform
- Sample rate
- Current time base
- Impulse Voltage
- AREA SIZE comparison ON/OFF
- Start position for AREA SIZE comparison
- End position for AREA SIZE comparison
- Percent difference for AREA SIZE comparison
- DIFF ZONE comparison ON/OFF
- Start position for DIFF ZONE comparison
- End position for DIFF ZONE comparison
- Percent difference for DIFF ZONE comparison
- CORONA comparison ON/OFF
- Start position for CORONA comparison
- End position for CORONA comparison
- Difference for CORONA comparison
- PHASE DIFF comparison ON/OFF
- Zero-crossing position for PHASE DIFF comparison
- Percent difference for PHASE DIFF comparison
- Statistic function ON/OFF
- Statistic data for all comparison method
- Statistic data for AREA SIZE comparison method
- Statistic data for DIFF ZONE comparison method
- Statistic data for CORONA comparison method
- Statistic data for PHASE DIFF comparison method
- Trigger Mode
- Averaging Rate
- Measurement delay time
- Comparator general ON/OFF
- Voltage automatic adjustment ON/OFF
- Standard waveform sample method
- Waveform display mode

Perform the following steps to store the control settings, comparison parameters and standard waveform to the internal non-volatile memory or external USB disk.

- 1) Select and set all control settings, comparison parameters, and sample the standard waveform on the <MEAS DISP> page before storing a file.
- 2) Move the cursor to the **FILE** field, the following softkey will be displayed.
  - FILE MANAGE
- 3) Press FILE MANAGE, the following softkeys will be displayed with the file list.

- LOAD
  - SAVE
  - DELETE
  - COPY
  - EXIT
- 4) Select a file No. from 1 to 560 (files from 61 to 560 are stored on the USB disk) using the cursor keys. Another way to locate a file is to input the file number directly using the numeric keys and press **ENTER** key.
  - 5) Press SAVE softkey, message “☺ *Input name: \_*” will be displayed on the system message and input line. The following softkeys corresponding to numeric key 2 will also be displayed as default softkeys.
    - A
    - B
    - C
    - -
    - ESC
  - 6) Enter a file name using both the softkeys and the entry keys. Upper case letters from A to Z, numbers from 0 to 9, and special characters such as (, ), /, \, @, #, \$, &, +, -, \*, % etc. can be used for a file name. The available softkeys for each numeric key are listed in Table3-1 .  
 To input a letter or character, first press one of the numeric keys and the available softkeys corresponding to the numeric key will be displayed, then use the softkey to enter a letter or character.  
 To input a number, first press the numeric key, and the available softkeys corresponding to the numeric key will be displayed, then press the same numeric key again to enter the number value you want.
  - 7) Press **ENTER** key to store the current settings, parameters and standard waveform. If the file name is not inputted, “<Unnamed>” will be used as the default name.
  - 8) Press EXIT softkey to exit the file manage and return back to the <MEAS DISP> Page.

**Table 3-1 Available Softkeys for Each Numeric Key**

<b>Entry keys</b>	<b>Softkeys</b>
<b>0</b>	(, ), /, \, ESC
<b>.</b>	@, #, \$, &, ESC
<b>1</b>	+, -, *, %, ESC
<b>2</b>	A, B, C, -, ESC
<b>3</b>	D, E, F, ESC
<b>4</b>	G, H, I, ESC
<b>5</b>	J, K, L, ESC
<b>6</b>	M, N, O, ESC
<b>7</b>	P, Q, R, S, ESC
<b>8</b>	T, U, V, ESC
<b>9</b>	W, X, Y, Z, ESC

Perform the following steps to load the control settings, comparison parameters and standard waveform from the internal non-volatile memory or an external USB disk.

- 1) Move the cursor to the **FILE** field, the following softkey will be displayed.
  - FILE MANAGE
- 2) Press FILE MANAGE, the following softkeys will be displayed with the file list.
  - LOAD
  - SAVE
  - DELETE
  - COPY
  - EXIT
- 3) Select a stored file No. from 1 to 560 (files from 61 to 560 are stored in the USB disk) using the cursor keys. Another way to locate a file is to input the file number directly using the numeric keys and press ENTER key.
- 4) Press LOAD softkey, message “☺ *Sure to load?*” will be displayed on the system message and input line. The following softkeys will also be displayed.
  - YES
  - NO
- 5) Press YES to load the file and return back to the <MEAS DISP> Page.
- 6) Press NO to cancel the load operation and return back to the display page of step 2.
- 7) Press EXIT softkey to exit the file manage and return back to the <MEAS DISP> Page.

Perform the following steps to delete a stored file.

- 1) Move the cursor to the **FILE** field, the following softkey will be displayed.
  - FILE MANAGE
- 2) Press FILE MANAGE, the following softkeys will be displayed with the file list.
  - LOAD
  - SAVE
  - DELETE
  - COPY
  - EXIT
- 3) Select a stored file No. from 1 to 560 (files from 61 to 560 are stored on the USB disk) using the cursor keys. Another way to locate a file is to input the file number directly using the numeric keys and press ENTER key.
- 4) Press DELETE softkey, message “☺ *Sure to delete?*” will be displayed on the system message and input line. The following softkeys will also be displayed.
  - YES
  - NO
- 5) Press YES to delete the file.
- 6) Press NO to cancel the delete operation.
- 7) Press EXIT softkey to exit the file manage and return back to the <MEAS DISP> Page.

Perform the following steps to copy a stored file.

- 1) Move the cursor to the **FILE** field, the following softkey will be displayed.
  - FILE MANAGE
- 2) Press FILE MANAGE, the following softkeys will be displayed with the file list.
  - LOAD
  - SAVE

- DELETE
  - COPY
  - EXIT
- 3) Press COPY softkey, message “☺ *Source File’s No.:\_?*” will be displayed on the system message and input line. The following softkey will be displayed.
    - EXIT
  - 4) Input the source file No. using the numeric keys and press **ENTER** key, message “☺ *Target File’s No.:\_*” will be displayed on the system message and input line.
  - 5) Input the target file No. using the numeric keys and press **ENTER** key, message “☺ *Input File’s Nums: \_*” will be displayed on the system message and input line.
  - 6) Use the numeric keys to input the number of files you want to copy from the source position to the target position.
  - 7) Press ENTER key to start copy operation. Message “☺ *Copying...*” will be displayed during copy operation and finally message “☺ *Copy completed*” will be displayed when copy operation is finished.
  - 8) Press EXIT softkey to exit the file manage and return back to the <MEAS DISP> Page.

### 3.1.5 Useful Tools

SME1203-1 provides several useful tools to make the operation easy and efficient.

Perform the following steps to use the tools function

- 1) Move the cursor to the **TOOL** field. The following softkeys will be displayed.
  - OPEN LOAD
  - CLOSE LOAD
  - CLOSE GRID
  - LOCK KEY
- 2) Press OPEN LOAD to enable the LOAD function and message “☺ *Open load OK!*” Will be displayed on the system message and input line for a while. Then each time when SME1203-1 is turned on, the file used last time will be reloaded automatically.
- 3) Press CLOSE LOAD to disable the LOAD function and message “☺ *Close load OK!*” will be displayed on the system message and input line for a while. Then next time when SME1203-1 is turned on, no file will be reloaded automatically.
- 4) Press CLOSE GRID to turn off the grid display. The following softkeys will be displayed.
  - OPEN LOAD
  - CLOSE LOAD
  - DISP GRID
  - LOCK KEY
- 5) Press DISP GRID to turn on the grid display again.
- 6) Press LOCK KEY to disable the key operation from the front panel except RELEASE KEY softkey. Message “☺ *Key locked*” and a sign of key “🔒” will be displayed on the system message and input line. The following softkeys will be displayed.
  - OPEN LOAD
  - CLOSE LOAD
  - DISP GRID

- RELEASE KEY

7) Press RELEASE KEY to enable the key operation from the front panel. If password function is enabled, you are required to input the password before unlocking the key operation.

### 3.1.6 Impulse Voltage

Perform the following steps to set the impulse voltage.

Impulse voltage range for SME1203-1-: 300 V to 3000 V with a 50 V resolution

Move the cursor to the impulse voltage display field, the following softkeys will be displayed.

- $\uparrow$  (++)

This softkey is the coarse impulse voltage adjustment softkey used to increase the impulse voltage by 500 V each time you press this softkey.

- $\uparrow$  (+)

This softkey is the fine impulse voltage adjustment softkey used to increase the impulse voltage by 50 V each time you press this softkey.

- $\downarrow$  (-)

This softkey is the fine impulse voltage adjustment softkey used to decrease the impulse voltage by 50 V each time you press this softkey.

- $\downarrow$  (--)

This softkey is the coarse impulse voltage adjustment softkey used to decrease the impulse voltage by 500 V each time you press this softkey.

**Note:** *Standard waveform must be measured again after the impulse voltage is changed. The previous standard waveform will be cleared and can not be recovered once the impulse voltage has been changed.*

### 3.1.7 Sample Rate





Different sample rates can be used for different windings in order to display the tested waveform with the best visual effect. The tested waveform with better visual effect can be compared more accurately.

Eight different sample rates are available as follows:



- 40/01 MSPS
- 40/02 MSPS
- 40/04 MSPS
- 40/08 MSPS
- 40/16 MSPS
- 40/32 MSPS
- 40/64 MSPS
- 40/128 MSPS.

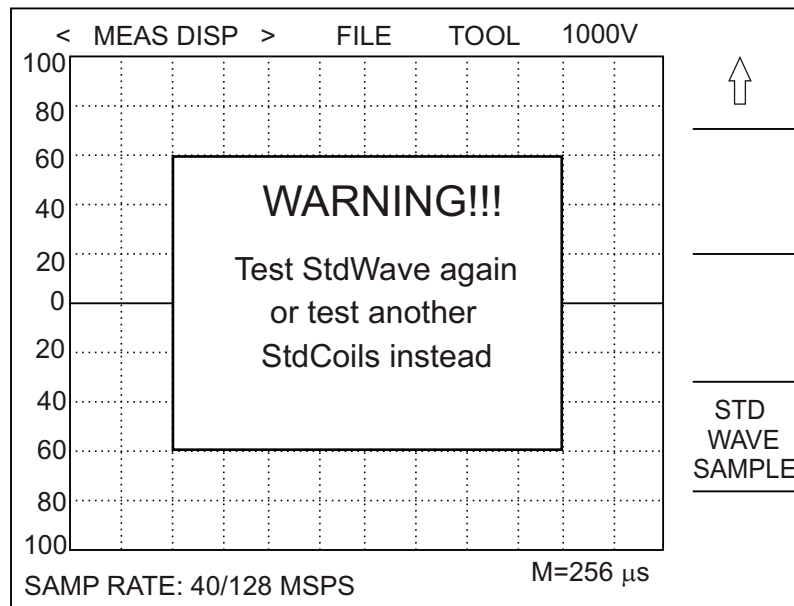


Perform the following steps to change the sample rate.

- 1) Move the cursor to the **SAMP RATE** display field, the following softkeys will be displayed.
  - 
  - 
  - STD WAVE SAMPLE
  - STD WAVE RESUME
- 2) Press  key to increase the sample rate. The current sample rate and time base displayed at the bottom of the LCD will be changed and the standard waveform will be cleared from the LCD screen.
- 3) Press  key to decrease the sample rate. The current sample rate and time base displayed at the bottom of the LCD will be changed and the standard waveform will be cleared from the LCD screen.
- 4) Press STD WAVE SAMPLE softkey to sample the standard waveform. SME1203-1 provides three kinds of standard waveform sample modes:
  - SEQ CYCLE
  - ONE CYCLE
  - ONE SAMPLE
- 5) Press STD WAVE RESUME softkey to display the previous waveform with original sample rate.

Perform the following steps to sample the standard waveform in SEQ CYCLE mode.

- 1) Move the cursor to the **SAMP RATE** display field, the following softkeys will be displayed.
  - 
  - 
  - STD WAVE SAMPLE
  - STD WAVE RESUME
- 2) Press STD WAVE SAMPLE softkey to sample the standard waveform. The waveforms sampled under different sample rates will be displayed in turn. Each waveform will be displayed for several seconds for you to choose. The following softkeys will be displayed.
  - CHOOSE  
Press CHOOSE softkey to choose the current displayed waveform as the standard waveform.
  - CHOOSE & CHECK  
Press CHOOSE & CHECK softkey to choose the current displayed waveform and SME1203-1 will test and sample the waveform again under the same sample rate. Only when the percent difference of differential area size between the two waveforms is less than 2%, the current displayed waveform can be chosen as the standard waveform.  
  
If the percent difference is more than 2%, then the previous waveform will not be chosen as a standard waveform. You have to test and choose again or change another standard winding. The following message will be displayed as shown in Figure 3-3.



**Figure 3-3 Warning Message**

■ **MEAS ABORT**

Press MEASABORT softkey to terminate the standard waveform sample operation.

Perform the following steps to sample the standard waveform in ONE CYCLE mode.

1) Move the cursor to the **SAMP RATE** display field, the following softkeys will be displayed.

- ↑
- ↓

- STD WAVE SAMPLE
- STD WAVE RESUME

2) Press STD WAVE SAMPLE softkey to sample the waveforms for all sample rates. The following softkeys will be displayed.

- ↑

Press ↑ softkey to view the sampled waveform under different sample rate.

- ↓

Press ↓ softkey to view the sampled waveform under different sample rate.

■ **CHOOSE**

Press CHOOSE softkey to choose the current displayed waveform as the standard waveform.

■ **CHOOSE & CHECK**

Press CHOOSE & CHECK softkey to choose the current displayed waveform and SME1203-1 will test and sample the waveform again under the same sample rate. Only when the percent difference of differential area size between the two waveforms is less than 2%, the

displayed waveform can be chosen as the standard waveform.



If the percent difference is more than 2%, then the previous waveform will not be chosen as a standard waveform. You have to test and choose again or change the standard winding. The following message will also be displayed as shown in Figure 3-3.



■ MEAS ABORT

Press MEAS ABORT softkey to terminate the standard waveform measurement.

Perform the following steps to sample the standard waveform in ONE SAMPLE mode.

1) Move the cursor to the **SAMP RATE** display field, the following softkeys will be displayed.

- 
- 
- STD WAVE SAMPLE
- STD WAVE RESUME

2) Press  or  softkey to select the sample rate you want.

3) Press STD WAVE SAMPLE softkey to sample the waveforms under the current sample rate. The sampled waveform will be displayed and chosen as the standard waveform.

### 3.2 Statistic Display Page

SME1203-1 provides the statistic function. The following statistic data are available for 4 different kinds of comparison methods as well as the combination of all comparison methods.

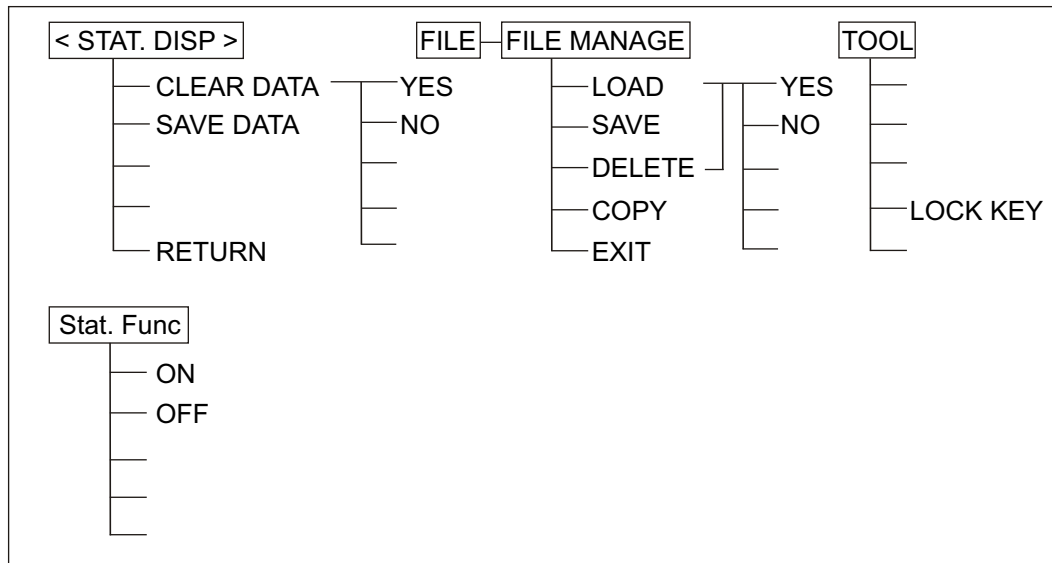
- Total quantity measured
- Quantity of passed devices
- The percent ratio of passed devices to the total quantity

When you press **DISP** and STAT. FUNC, the <STAT. DISP> page will be displayed. The available fields and softkeys which correspond to each field on this page are shown in Figure 3-4 and Figure 3-5.

< STAT. DISP >				<b>FILE</b>	<b>TOOL</b>	CLEAR DATA
STAT. Func :		<b>OFF</b>				SAVE DATA
ITEAM	TOTAL	PASSED	RATIO			
ALL	100	80	80.00%			
AREA	100	99	99.00%			
DIFF	100	85	85.00%			
CORONA	100	83	83.00%			
PHASE	0	0	**.**%			
Current File's No. : 0					RETURN	
☺ Use softkey to select						

 : Fields

**Figure 3-4 Available Fields on the STAT. DISP Page**



**Figure 3-5 Available Softkeys on the STAT. DISP Page**

### 3.2.1 Statistic Function ON/OFF

When statistic function is ON, the comparison results of each measurement will be counted and calculated as the statistic data. When statistic function is OFF, the comparison results of each measurement will not be counted or calculated.

Perform the following steps to turn ON/OFF the statistic function.

- 1) Move the cursor to the **Stat. Func** display field, the following softkeys will be displayed.
  - ON
  - OFF
- 2) Press ON to turn on the statistic function, press OFF to turn off the statistic function.

### 3.2.2 Clear the Statistic Data

Perform the following steps to clear the data to a file.

- 1) Move the cursor to the <STAT. DISP> field, and the following softkeys will be displayed.
  - CLEAR DATA
  - SAVE DATA
  - RETURN
- 2) Press CLEAR DATA to clear the statistic data displayed in the table. The message "Sure to clear?" will be displayed on the system message line and following softkeys will be displayed.
  - YES
  - NO
- 3) Press YES to clear the date in the table, press NO to cancel the clear data operation.
- 4) Press RETURN softkey to exit from the <STAT. DISP> page and return back to the <MEAS DISP> page.

### 3.2.3 Save the Statistic Data to the Current File

Perform the following steps to save the statistic data to the current file.

- 1) Move the cursor to the <STAT. DISP> field, and the following softkeys will be displayed.
  - CLEAR DATA
  - SAVE DATA
  - RETURN
- 2) Press SAVE DATA to save the statistic data displayed in the table to the current file. The message “☺ Saving...” will be displayed on the system message line and “☺ Saving completed” will be displayed after saving operation is finished.
- 3) Press RETURN softkey to exit from the <STAT. DISP> page and return back to the <MEAS DISP> page.

### 3.2.4 File Manager

Please refer to “3.1.4 File Manager”

### 3.2.5 Useful Tools

Perform the following steps to use the tools function on <STAT. DISP> page.

- 1) Move the cursor to the **TOOL** field. The following softkeys will be displayed.
  - LOCK KEY
- 2) Press LOCK KEY to disable the key operation from the front panel except RELEASE KEY softkey. Message “☺ Key locked” and a sign of key ⌘ will be displayed on the system message line. The following softkeys will be displayed instead.
  - RELEASE KEY
- 3) Press RELEASE KEY to enable the key operation from the front panel. The sign of key ⌘ will be turned off.

# Chapter 4 SETUP Menu Operation

This chapter provides information for each function under the <MEAS SETUP> page.

## 4.1 MEAS DISP Page

When you press SETUP menu key, the <MEAS SETUP> page will be displayed. On this <MEAS DISP> page, all of the following measurement control functions can be set. Each field in parenthesis is used when each control is set.

- Impulse Voltage (**IMP VOLT**)
- Trigger Mode (**TRIG MODE**)
- Averaging Rate (**AVG TIMES**)
- Delay Time (**DELAY**)
- Comparator ON/OFF (**COMPARATOR**)
- Voltage Adjustment ON/OFF (**VOLT ADJ**)
- Standard Waveform Sample Mode (**SWAVE SAMP**)
- Waveform Display Mode (**WAVE DISP**)
- ON/OFF State for each comparison method
- Start and End Positions for each comparison method
- Difference limit for each comparison method
- File Manager (**FILE**)
- Useful Tools (**TOOL**)

The available fields and the softkeys which correspond to the fields on this page are shown in Figure 4-1 and Figure 4-2 respectively.

< MEAS SETUP >
[FILE] [TOOL]

IMP VOLT : [1000V]

AVG TIMES : [5]

COMPARATOR : [ON]

SWAVE SAMP : [ONE CYCLE]

WAVE DISP : [ALL ON]

TRIG MODE : [MAN]

DELAY : [1.0s]

VOLT ADJ : [ON]

↑ (++)

---

↑ (+)

---

↓ (-)

---

↓ (--)

STAT	METHOD	POSIT	DIFF
[x]	AREA SIZE	[000]—[960]	[2.0%]
[✓]	DIFF ZONE	[100]—[800]	[2.0%]
[x]	CORONA	[050]—[300]	[10]
[x]	PHASE DIFF	[2]	[2.0%]

Table:comparison terms

☺ Input data or use ↑,↑,↓,↓select

[ ] :Fields

**Figure 4-1 Available Fields on the MEAS SETUP Page**

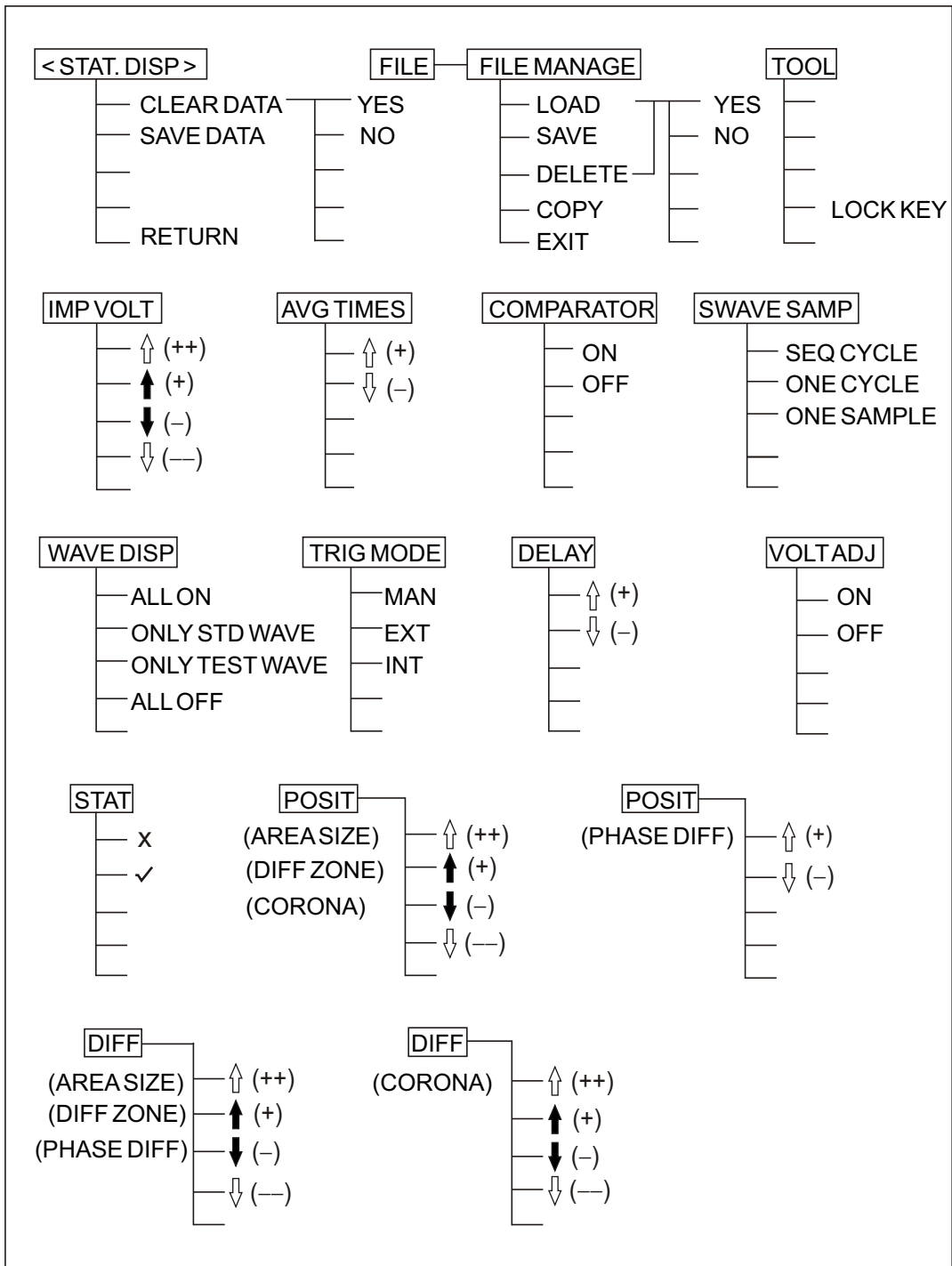


Figure 4-2 Available Softkeys on the MEAS SETUP Page

#### 4.1.1 Impulse Voltage

Perform the following steps to set the impulse voltage.

Impulse voltage range for SME1203-1: 300 V to 3000 V with a 50 V resolution

- 1) Move the cursor to the **IMP VOLT** field, the following softkeys will be displayed.
  - $\uparrow$  (++)  
This softkey is the coarse impulse voltage adjustment softkey used to increase the impulse voltage by 500 V each time you press this softkey.
  - $\uparrow$  (+)  
This softkey is the fine impulse voltage adjustment softkey used to increase the impulse voltage by 50 V each time you press this softkey.
  - $\downarrow$  (-)  
This softkey is the fine impulse voltage adjustment softkey used to decrease the impulse voltage by 50 V each time you press this softkey.
  - $\downarrow$  (--)  
This softkey is the coarse impulse voltage adjustment softkey used to decrease the impulse voltage by 500 V each time you press this softkey.
- 2) You can also input the impulse voltage value using the entry keys. When one of the numeric entry keys is pressed, the following unit softkeys will be displayed, these can be used instead of **ENTER** key. If **ENTER** is used to terminate the impulse voltage input, unit V will be used as the default unit.
  - kV
  - V
  - EXIT
- 3) Press EXIT key to cancel the impulse voltage input process.

**Note:** *Standard waveform must be sampled again after the impulse voltage is changed. The previous standard waveform will be cleared and can not be recovered once the impulse voltage has been changed.*

#### 4.1.2 Trigger Mode

SME1203-1 provides four kinds of trigger modes: MANual, EXTernal, INTernal, and BUS. When the trigger mode is set to MAN trigger mode, the SME1203-1 performs a single measurement on <MEAS DISP> page every time **START** key on the front panel or a footswitch is pressed.

When the trigger mode is set to EXT trigger mode, the SME1203-1 performs a single measurement on <MEAS DISP> page every time a positive going TTL pulse (more than 1  $\mu$ s) is applied to the EXT TRIGGER pin of the Handler interface.

When the trigger mode is set to INT trigger mode, the SME1203-1 starts a measurement once **START** key is pressed on <MEAS DISP> page, and then the SME1203-1 will continuously



Measurements until MEAS EXIT softkey or **START** key is pressed again. When the trigger mode is set to BUS trigger mode, the SME1203-1 performs a single measurement every time the TRIGGER command is sent to the SME1203-1 via GPIB or RS232C interface. The BUS trigger mode cannot be set on the front panel.

**NOTE: SME1203-1 ignores triggers that are applied while a measurement is in progress. Trigger the SME1203-1 after the measurement is completed.**

Perform the following steps to set the trigger mode except for in the BUS TRIG mode. To set the trigger mode in the BUS mode, the TRIGGER command should be sent via GPIB or RS232C interface.

- 1) Move the cursor to the **TRIG MODE** field. The following softkeys will be displayed.
  - MAN
  - EXT
  - INT
- 2) Set the trigger mode using the softkeys.

#### 4.1.3 Averaging Rate

The **SME1203-1** averaging rate function arithmetically averages the results of two or more measurements. The number of measurements averaged can be set from 1 to 99, in steps of 1. Perform the following steps to set the averaging rate.

- 1) Move the cursor to the **AVG TIMES** field. The following softkeys will be displayed.
  - $\uparrow$  (+)  
This softkey is used to increase the averaging rate.
  - $\downarrow$  (-)  
This softkey is used to decrease the averaging rate.
- 2) Use the softkeys to set the averaging rate, or enter an averaging rate using the numeric entry keys, and **ENTER**.

#### 4.1.4 Delay Time

The delay time function is only available when trigger mode is set to INT trigger mode. The SME1203-1's delay time function allows you to set a trigger delay so the SME1203-1 will delay the start of the measurement after it is triggered. The trigger delay time can be set from 0 s to 99 s in 0.1 s steps.

Perform the following steps to set the delay time.

- 1) Move the cursor to the **DELAY** field. The following softkeys will be displayed.
  - $\uparrow$  (+)  
This softkey is used to increase the delay time in 0.1s steps.
  - $\downarrow$  (-)  
This softkey is used to decrease the delay time in 0.1s steps.
- 2) Use the softkeys to set the delay time, or enter the averaging rate using the numeric entry keys, and **ENTER**.

#### 4.1.5 Comparator Function ON/OFF

The SME1203-1 has four kinds of built-in comparators used to compare the difference between the standard waveform and tested waveform. The limit settings for each comparator can be set on the <MEAS DISP> page or <MEAS SETUP> page. This comparator function allows you to set all the comparators to ON or OFF.

Perform the following steps to set all the comparators to ON or OFF.

- 1) Move the cursor to the **COMPARATOR** field. The following softkeys will be displayed.
  - ON
  - OFF
- 2) Use the softkeys to set all the comparators to ON or OFF. When the comparators are turned on, a standard waveform must be available before performing a measurement. You can either load a standard waveform from a stored file or sample a standard waveform with a standard winding. When the comparators are all turned off, you can test a winding without a standard waveform.

#### 4.1.6 Voltage Adjustment ON/OFF

The actual test impulse voltage may be different from your desired voltage or set voltage due to the different loads. The voltage adjustment function regulates the actual test impulse voltage to your set voltage. By using this function, the test impulse voltage at the DUT (device under test) can be held constant.

When the voltage adjustment function fails to regulate the impulse voltage to your desired voltage, a warning message "OVER LOAD Reduce volt to test" will be displayed as shown in Figure 4-3.

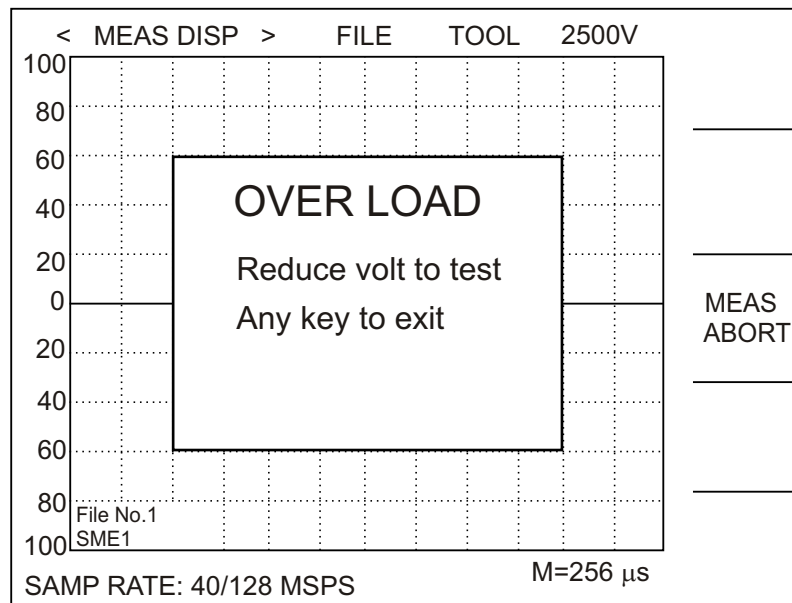


Figure 4-3 Overload Error Message

Perform the following steps to set the voltage adjustment function to ON or OFF.

- 1) Move the cursor to the **VOLT ADJ** field. The following softkeys will be displayed.
  - ON
  - OFF
- 2) Use the softkeys to set the voltage adjustment function to ON or OFF.

#### 4.1.7 Standard Waveform Sample Mode

SME1203-1 provides three kinds of standard waveform sample modes:

- SEQ CYCLE
- ONE CYCLE
- ONE SAMPLE.

Perform the following steps to set the standard waveform sample mode.

- 1) Move the cursor to the **SWAVE SAMP** field. The following softkeys will be displayed.
  - SEQ CYCLE
  - ONE CYCLE
  - ONE SAMPLE
- 2) Use the softkeys to set the standard wave sample mode.

#### 4.1.8 Waveform Display Mode

There are four kinds of waveform display mode available.

- ALL ON  
Both the standard waveform and the tested waveform are displayed on the LCD at the same time.
- ONLY STD WAVE  
Only the standard waveform is displayed on the LCD.
- ONLY TEST WAVE  
Only the tested waveform is displayed on the LCD.
- ALL OFF  
Both the standard waveform and the tested waveform will not be displayed on the LCD.

Perform the following steps to set the waveform display mode.

- 1) Move the cursor to the **WAVE DISP** field. The following softkeys will be displayed.
  - ALL ON
  - ONLY STD WAVE
  - ONLY TEST WAVE
  - ALL OFF
- 2) Use the softkeys to set the waveform display mode.

#### 4.1.9 ON/OFF State for each comparison method

The ON/OFF state for each comparison method is valid only when Comparator Function is turned ON referring to “4.1.7 Comparator Function ON/OFF”

Perform the following steps to set the ON/OFF state for each comparison methods.

- 1) Move the cursor to the corresponding **STATE** field of each comparison method. The following

Softkeys will be displayed.

- ×
- ✓

- 2) Press ✓ softkey to turn on the corresponding comparison function. Press × softkey to turn off the corresponding comparison function.

#### 4.1.10 Start and End Positions for each comparison method

Perform the following steps to set the start and end positions for AREA SIZE, DIFF ZONE and CORONA comparison methods and set the zero-crossing position for PHASE DIFF comparison method.

- 1) Move the cursor to the corresponding start **POSITE** field of AREA SIZE, DIFF ZONE or CORONA comparison method. The following softkeys will be displayed.

- ↑ (++)

This softkey is the coarse increment softkey used to increase the start position by 40 dots each time you press this softkey.

- ↑ (+)

This softkey is the fine increment softkey used to increase the start position by one dot each time you press this softkey.

- ↓ (-)

This softkey is the fine decrement softkey used to decrease the start position by one dot each time you press this softkey.

- ↓ (--)

This softkey is the coarse decrement softkey used to decrease the start position by 40 dots each time you press this softkey.

- 2) You can also enter the start position using the numeric entry keys, and ENTER.

- 3) Move the cursor to the corresponding end **POSITE** field of AREA SIZE, DIFF ZONE or CORONA comparison method. The following softkeys will be displayed.

- ↑ (++)

This softkey is the coarse increment softkey used to increase the end position by 40 dots each time you press this softkey.

- ↑ (+)

This softkey is the fine increment softkey used to increase the end position by one dot each time you press this softkey.

- ↓ (-)

This softkey is the fine decrement softkey used to decrease the end position by one dot each time you press this softkey.

- ↓ (--)

This softkey is the coarse decrement softkey used to decrease the end position by 40 dots each time you press this softkey.

- 4) You can also enter the end position using the numeric entry keys, and ENTER.

- 5) Move the cursor to the corresponding **POSITE** field of PHASE DIFF comparison method. The following softkeys will be displayed.

- $\uparrow$  (+)  
Press this softkey to increase the zero-crossing position by one.
  - $\downarrow$  (-)  
Press this softkey to decrease the zero-crossing position by one.
- 6) You can also enter the zero-crossing position using the numeric entry keys, and ENTER.

#### 4.1.11 Difference limit for each comparison method

Perform the following steps to set the percent difference for AREA SIZE, DIFF ZONE and PHASE DIFF comparison methods and set the absolute difference for CORONA comparison method.

- 1) Move the cursor to the corresponding **DIFF** field of AREA SIZE, DIFF ZONE or PHASE DIFF comparison method. The following softkeys will be displayed.
  - $\uparrow$  (++)  
This softkey is the coarse increment softkey used to increase the percent difference by 1% each time you press this softkey.
  - $\uparrow$  (+)  
This softkey is the fine increment softkey used to increase the percent difference by 0.1% each time you press this softkey.
  - $\downarrow$  (-)  
This softkey is the fine decrement softkey used to decrease the percent difference by 0.1% each time you press this softkey.
  - $\downarrow$  (--)  
This softkey is the coarse decrement softkey used to decrease the percent difference by 1% each time you press this softkey.
- 2) You can also enter the percent difference using the numeric entry keys, and ENTER.
- 3) Move the cursor to the corresponding **DIFF** field of CORONA comparison method. The following softkeys will be displayed.
  - $\uparrow$  (++)  
This softkey is the coarse increment softkey used to increase the absolute difference by 10 each time you press this softkey.
  - $\uparrow$  (+)  
This softkey is the fine increment softkey used to increase the absolute difference by 1 each time you press this softkey.
  - $\downarrow$  (-)  
This softkey is the fine decrement softkey used to decrease the absolute difference by 1 each time you press this softkey.
  - $\downarrow$  (--)  
This softkey is the coarse decrement softkey used to decrease the absolute difference by 10 each time you press this softkey.
- 4) You can also enter the absolute difference using the numeric entry keys, and ENTER.

#### 4.1.12 File Manager

Please refer "3.1.4 File Manager"

#### 4.1.12 Useful Tools

Please refer "3.1.5 Useful Tools"

# Chapter 5 SYSTEM Menu Operation

This chapter provides information for each function under the <SYSTEM SETUP> page.

## 5.1 SYSTEM SETUP Page

When you press SYSTEM menu key, the <SYSTEM SETUP> page will be displayed. On this <SYSTEM SETUP> page, all of the following system control functions can be set. Each field in parenthesis is used when each control is set.

- LCD Contrast Adjustment (**LCD CONST**)
- Alarm Mode for Pass (**PASS ALARM**)
- Alarm Mode for Fail (**FAIL ALARM**)
- PASS/FAIL display (**PASS&FAIL**)
- Keystroke Beeper ON/OFF (**KEY BEEP**)
- Display Language (**LANGUAGE**)
- Password Protection (**PASSWORD**)
- Bus Operation Mode (**BUS MODE**)
- GPIB Address (**BUS ADDRESS**)
- Test Mode (**TEST MODE**)
- File Manager (**FILE**)
- Useful Tools (**TOOL**)

The available fields and the softkeys which correspond to the fields on this page are shown in Figure 5-1 and Figure 5-2 respectively.

< SYSTEM SETUP >		FILE	TOOL
LCD CONST	:	18	
PASS ALARM	:	OFF	
FAIL ALARM	:	LONG HIGH	
PASS & FAIL	:	ON	
KEY BEEP	:	OFF	
LANGUAGE	:	ENGLISH	
PASSWORD	:	OFF	
BUS MODE	:	RS232C	
BUS ADDR	:	8	
TEST MODE	:	SINGLE	
☺ Welcome to use			
			: Fields

Figure 5-1 Available Fields on the SYSTEM SETUP Page

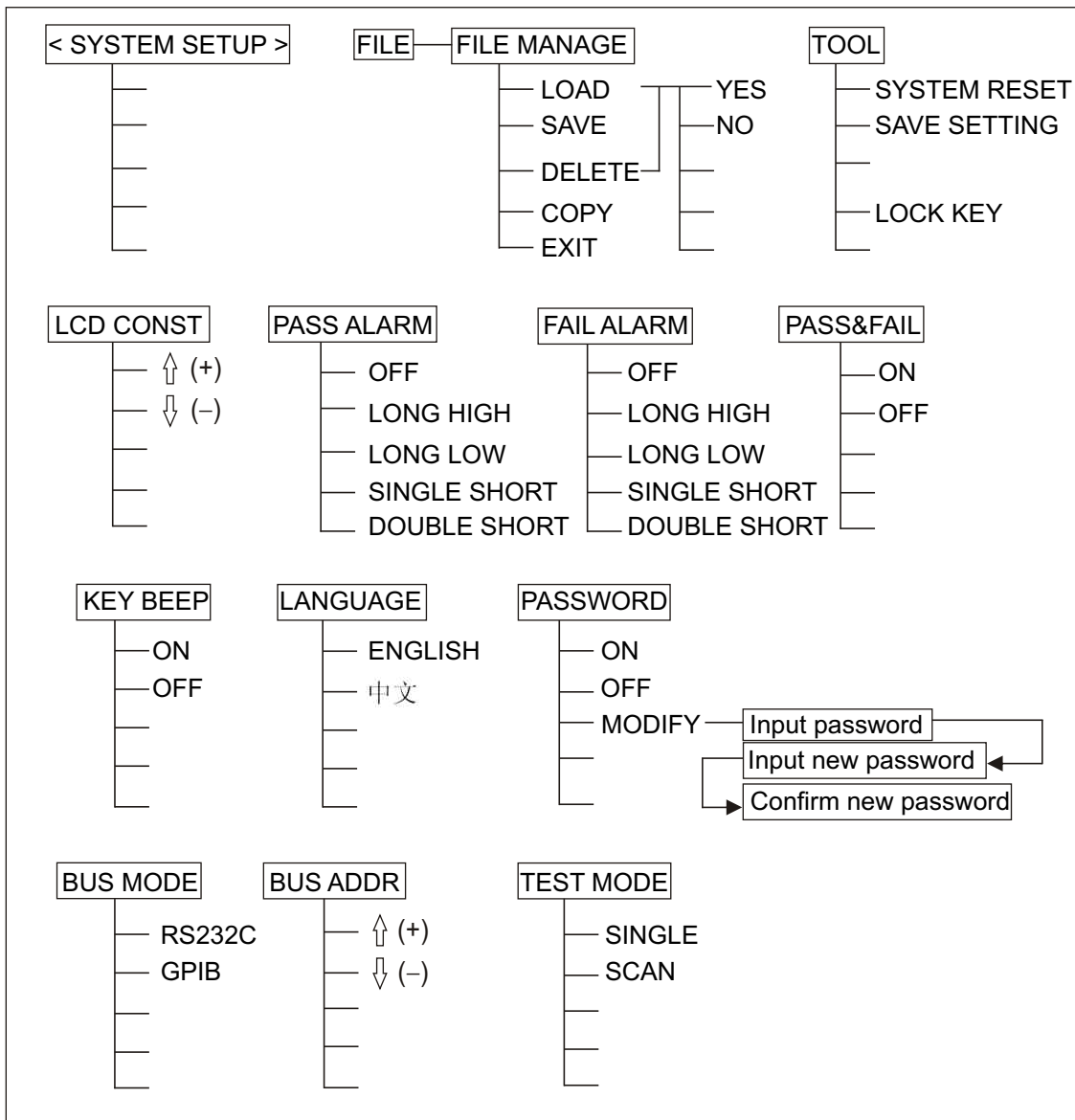


Figure 5-2 Available Softkeys on the SYSTEM SETUP Page

### 5.1.1 LCD Contrast Adjustment

Perform the following steps to adjust the LCD's CONTRAST.

- 1) Move the cursor to the **LCD CONST** field on the <SYSTEM SETUP> page. The following softkeys will be displayed in the softkey label area.
  - ↑ (+)
  - ↓ (-)
- 2) Use the softkeys to adjust the LCD's contrast from 1 to 31 until you get the proper contrast effect.

### 5.1.2 Alarm Mode for PASS

There are five alarm modes available for PASS state:

- OFF  
No alarm.
- LONG HIGH  
Emit a long and high beep when the comparison result is PASS.
- LONG LOW  
Emit a long and low beep when the comparison result is PASS.
- SINGLE SHORT  
Emit a single short beep when the comparison result is PASS.
- DOUBLE SHORT  
Emit two short beeps when the comparison result is PASS.

Perform the following steps to set the alarm mode for PASS state.

- 1) Move the cursor to the **PASS ALARM** field on the <SYSTEM SETUP> page. The following softkeys will be displayed in the softkey label area.
  - OFF
  - LONG HIGH
  - LONG LOW
  - SINGLE SHORT
  - DOUBLE SHORT
- 2) Use the softkeys to set the alarm mode for PASS state.

### 5.1.3 Alarm Mode for FAIL

There are also five alarm modes available for FAIL state:

- OFF  
No alarm.
- LONG HIGH  
Emit a long and high beep when the comparison result is FAIL.
- LONG LOW  
Emit a long and low beep when the comparison result is FAIL.
- SINGLE SHORT  
Emit a single short beep when the comparison result is FAIL.
- DOUBLE SHORT  
Emit two short beeps when the comparison result is FAIL.

Perform the following steps to set the alarm mode for FAIL state.

- 1) Move the cursor to the **FAIL ALARM** field on the <SYSTEM SETUP> page. The following softkeys will be displayed in the softkey label area.
  - OFF
  - LONG HIGH
  - LONG LOW
  - SINGLE SHORT
  - DOUBLE SHORT
- 2) Use the softkeys to set the alarm mode for FAIL state.



#### 5.1.4 PASS/FAIL Display ON/OFF

When PASS/FAIL display function is turned ON, then **PASS** or **FAIL** message will be displayed on the LCD screen.

Perform the following steps to set PASS/FAIL display function to ON or OFF.

- 1) Move the cursor to the **PASS & FAIL** field on the <SYSTEM SETUP> page. The following softkeys will be displayed in the softkey label area.
  - ON
  - OFF
- 2) Use the softkeys to turn ON/OFF the PASS/FAIL display function.

#### 5.1.5 Keystroke Beeper ON/OFF

When Keystroke Beeper function is turned ON, TH2882 will emit a beep each time a key is Pressed.

Perform the following steps to set the Keystroke Beeper function to ON or OFF.

- 1) Move the cursor to the **KEY BEEP** field on the <SYSTEM SETUP> page. The following softkeys will be displayed in the softkey label area.
  - ON
  - OFF
- 2) Use the softkeys to turn ON/OFF the Keystroke Beeper function.

#### 5.1.6 Display Language

SME1203-1 provides two kinds of system languages used for display and operation:

- English
- Chinese.

Perform the following steps to select the system Language.

- 1) Move the cursor to the **LANGUAGE** field on the <SYSTEM SETUP> page. The following softkeys will be displayed in the softkey label area.
  - ENGLISH
  - 中文
- 2) Use the softkeys to select the language you need.

#### 5.1.7 Password Protection

SME1203-1 needs a password in the following conditions.

- Turn on the instrument on Welcome page ( if password is turned ON)
- To unlock the key operation ( if password is turned ON)
- Set the password function to OFF
- Change the password.

**Note:** The default password for SME1203-1 is “2882”.

Perform the following steps to turn ON/OFF or modify the password.

- 1). Move the cursor to the **PASSWORD** field on the <SYSTEM SETUP> page. The following softkeys will be displayed in the softkey label area.
  - ON
  - OFF
  - MODIFY

- 1) Press ON to turn on the password function.
- 2) Press OFF, “☺ Input password: \_” will be displayed on the system information line. Input the correct password, and the password function will be turned OFF.
- 3) Press MODIFY, “☺ Input password: \_” will be displayed on the system information line.
- 4) Input the correct password, “☺ New password: \_” will be displayed on the system information line.
- 5) Input the new password, “☺ Confirm new password: \_” will be displayed on the system information line.
- 6) Input the new password again, “☺ Modify password completed” will be displayed on the system information line.
- 7) If the new password is wrongly entered, “☹ Modify password failed!” will be displayed.

**Note:** The password function ON/OFF state and new password will be valid as soon as they are changed. But they will not be valid after the SME1203-1 is turned off unless the SAVE SETTING function within the **TOOL** field is executed before the SME1203-1 is turned OFF.

#### 5.1.8 Bus Operation Mode

SME1203-1 provides two kinds of bus operation mode: RS232C and GPIB.

Perform the following steps to select the bus operation mode.

- 1) Move the cursor to the **BUS MODE** field on the <SYSTEM SETUP> page. The following softkeys will be displayed in the softkey label area.
  - RS232C
  - GPIB
- 2) Use the softkeys to select the bus operation mode.

#### 5.1.9 GPIB Address

SME1203-1's GPIB address can be set from 1 to 31.

Perform the following steps to set the GPIB address.

- 1) Move the cursor to the **BUS ADDR** field on the <SYSTEM SETUP> page. The following softkeys will be displayed in the softkey label area.
  - ↑ (+)
  - ↓ (-)
- 2) Use the softkeys to set the GPIB address.

#### 5.1.10 Test Mode Setup

When the optional SCANNER interface is installed inside the SME1203-1, then SME1203-1 can be operated under the SCAN measurement mode.

Perform the following steps to set the test mode.

- 1) Move the cursor to the **TEST MODE** field on the <SYSTEM SETUP> page. The following softkeys will be displayed in the softkey label area.
  - SINGLE
  - SCAN
- 2) Use the softkeys to set the test mode.

### 5.1.11 File Manager

Please refer to “3.1.4 File Manager”

### 5.1.12 Useful Tools

SME1203-1 provides several useful tools to make the operation easy and efficient.

Perform the following steps to use the tool function on <SYSTEM SETUP> page.

- 1) Move the cursor to the **TOOL** field. The following softkeys will be displayed.
  - SYSTEM RESET
  - SAVE SETTING
  - LOCK KEY
- 2) Press SYSTEM RESET to reset the SME1203-1 without turning off the power supply.
- 3) Press SAVE SETTING to save the setups on the <SYSTEM SETUP> display page. LOAD ON/OFF state, GRID ON/OFF state, and KEYLOCK state on the <MEAS DISP> display page will also be saved at the same time.
- 4) Press LOCK KEY to disable the key operation from the front panel except RELEASE KEY softkey. Message “☺ *Key locked*” and a sign of key ⌘ will be displayed on the system message line. The following softkeys will be displayed.
  - SYSTEM RESET
  - SAVE SETTING
  - RELEASE KEY
- 5) Press RELEASE KEY to resume the key operation from the front panel.

# Chapter 6 Remote Operation

Besides the front panel control, SME1203-1 supports RS-232 serial interface and GPIB parallel interface for remote control. You can use only one interface at a time. Standard Commands for Programmable Instruments (SCPI) is fully supported by the RS-232 and GPIB interfaces, however they use different hardware configurations and communication protocols.

## 6.1 RS-232 Interface Operation

The instrument provides various remote commands. All operations from the front panel can be performed by a computer via the RS-232 interface.

### 6.1.1 RS-232 Connection

RS232C standard now is widely used as the serial communication standard. RS232 stands for Recommend Standard number 232 and C is the latest revision of the standard. The serial ports on most instruments use a subset of the RS232C standard. The full RS232C standard specifies a 25-pin “D” connector of which 22 pins are used. Most of these pins are not needed for normal serial communications, and the common RS232 signals are listed in Table 6-1:

**Table 6-1 Signal Definition for 9 Pin Connector**

Function	Code	9 Pin Connector Pin Number
Request To Send	RTS	7
Clear To Send	CTS	8
Data Set Ready	DSR	6
Data Carrier Detect	DCD	1
Data Terminal Ready	DTR	4
Transmitted Data	TXD	3
Received Data	RXD	2
Signal Ground Common	GND	5

SME1203-1’s serial port uses the transmit (TXD), receive (RXD), and signal ground (GND) lines of the RS232 standard. It does not use the hardware handshaking lines CTS and RTS. So SME1203-1 only uses the smallest subset of the RS232C standard, the signal are listed in Table 6-2.

**Table 6-2 Signal Definition for SME1203-1**

Function	Code	9 Pin Connector Pin Number
Transmitted Data	TXD	3
Received Data	RXD	2
Signal Ground Common	GND	5

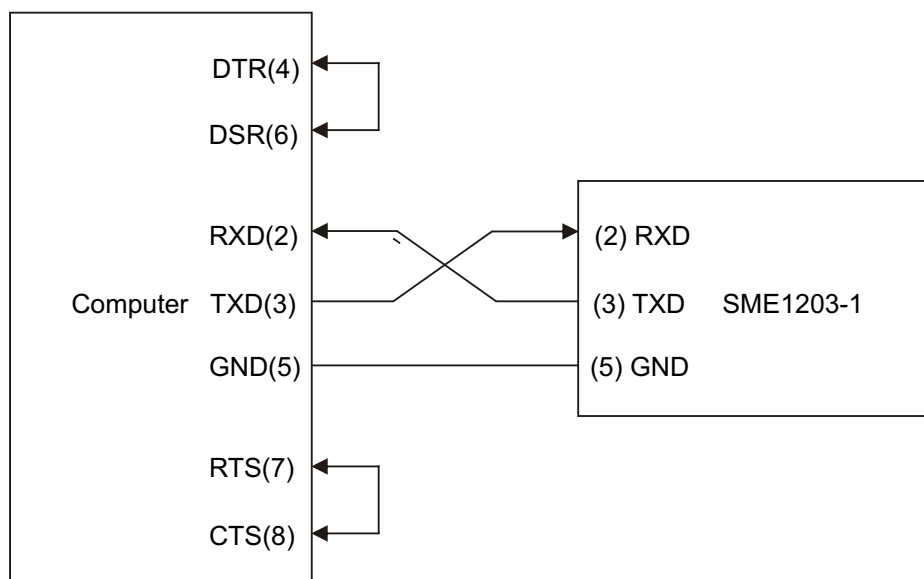
Figure 6-1 shows the rear panel connector for the RS232 interface.

RS-232C



**Figure 6-1 Rear Panel Rs232 Interface**

Connection between SME1203-1 and a computer shown as Figure 6-2.



**Figure 6-2 RS-232 Connection Sketch**

There may be some difference between SME1203-1 RS232 interface and a standard RS232C interface. You can make the connection cable by yourself according the diagram or order one from our company.

**Note:** *Pin 4 and 6, pin 7 and 8 are shorted respectively at the end of controller.*

### 6.1.2 Serial Interface Specifications

- Baud Rate: 38400 bps
- Data Bits: 8 Bits
- Stop Bits: 1 Bit
- Parity Bits: None
- Connector: DB9
- Terminal Character: NL (New Line ASCII Code 10)

### 6.1.3 Software Protocol

1. For command syntax and format, refer to “Chapter 8 SCPI Command Reference”.
2. The controller transmits the command using the ASCII code with <NL> as the terminal character (New Line, ASCII code is 10). SME1203-1 executes the command after the terminal character <NL> is received.
3. Once a query command is received, SME1203-1 will send the query response information immediately even if the rest commands have not been finished. So if the command includes two queries, the controller should read the query responses twice. One query is recommended to be included in a single command.
4. A query response is sent out in ASCII codes with <NL> as the terminal character.
5. Several query responses will be sent continuously with 1ms interval. The controller should be ready to receive the responses; otherwise the response information will be lost.
6. For some commands that will take a long time to execute, for example reset command, the controller should keep waiting to avoid the next command being lost when SME1203-1 is executing the former command.
7. The query response of waveform data is sent out in ASCII codes with <NL> as the terminal character. If <NL> is received as the first ASCII code, this means that there is no waveform data available.

## 6.2. GPIB interface optional

This section contains information about GPIB bus standard, connecting to and using the GPIB interface.

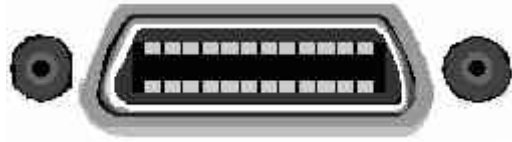
### 6.2.1 GPIB Connection

When configuring a GPIB system, the following restrictions must be adhered to.

- The total length of cable in one bus system must be less than or equal to two meters times the number of devices connected on the bus (the GPIB controller counts as one device) and the total length of cable must not exceed 20 meters.
- A maximum of 15 devices can be connected on one bus system.
- There are no restrictions on how the cables are connected together. However, it is recommended that no more than four piggyback connectors be stacked together on any one

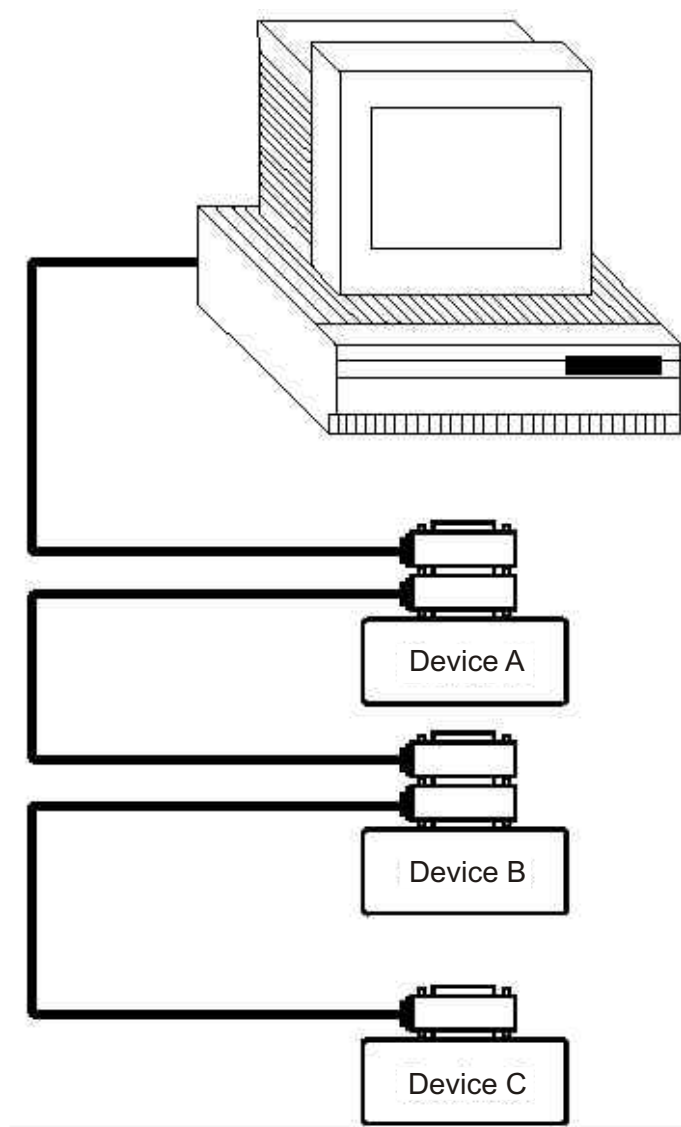
device. The resulting structure could exert enough force on the connector mounting to damage it.

Figure 6-3 shows the GPIB interface on the rear panel of SME1203-1.

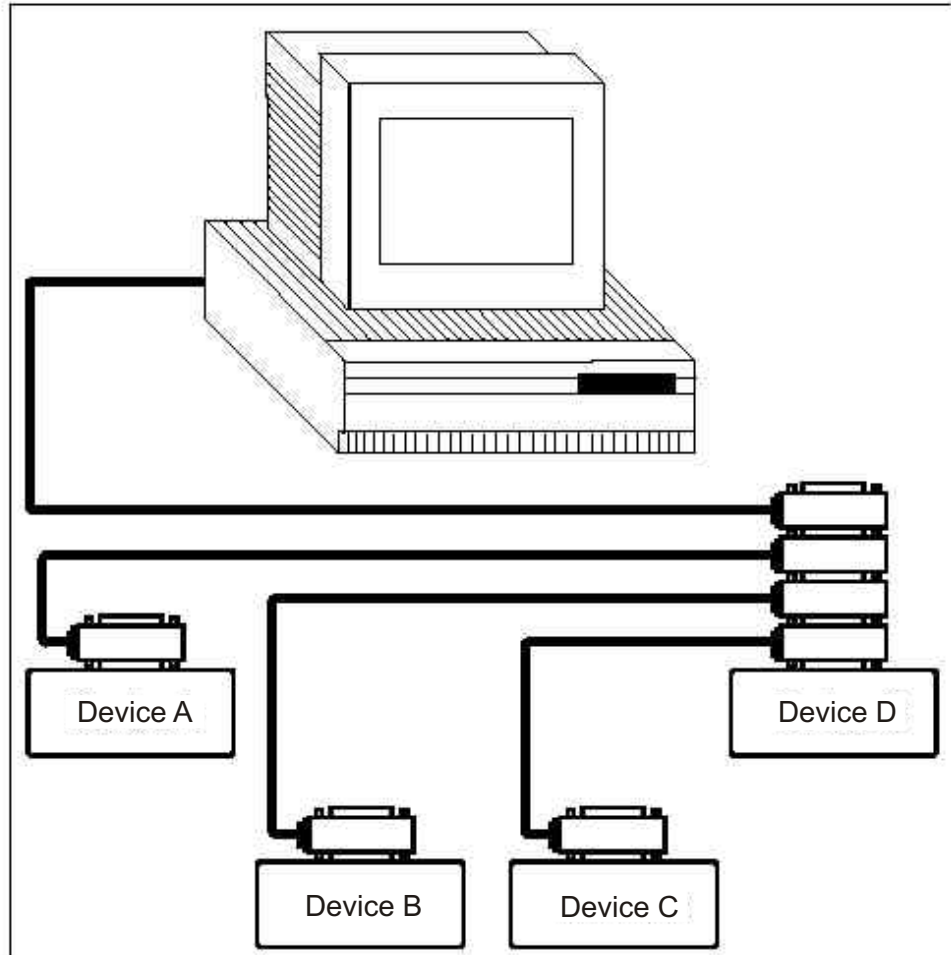


**Figure 6-3 Rear Panel GPIB Interface**

To allow many parallel connections to one instrument, stack the connector. Two screws are located on each connector to ensure that connections remain secure. Figure 6-4 and Figure 6-5 show two kinds of typical GPIB system interconnections.



**Figure 6-4 Typical GPIB System Interconnection-1**



**Figure 6-5 Typical GPIB System Interconnection-2**



## 6.2.2 GPIB Interface Capability

Table 6-3 lists the SME1203-1's GPIB capabilities and functions. These functions provide the mean for an instrument to receive, process, and transmit commands, data, and status over the GPIB bus.

**Table 6-3 GPIB interface Capability**

<b>Code</b>	<b>Function</b>
SH1	Complete Source Handshake capability
AH1	Complete Acceptor Handshake capability
T5	Basic Talker; Talk-Only; Unaddressed if MLA; no serial poll.
L4	Basic Listener; Unaddressed if MTA; no Listen Only.
RL1	Remote/Local capability
DC1	Device Clear capability
DT1	Device Trigger capability
C0	No controller capability
E1	Drivers are open-collector

## 6.2.3 GPIB Addressing

SME1203-1 is shipped from the factory with a GPIB address of 8. You can set the address to a value of 1 to 31 and the address is saved in the non-volatile memory. Do not assign the same address to another device or a controller that are on the same GPIB bus system.

## 6.2.4 General Bus Commands

General commands are those commands, such as DCL, that have the same general meaning regardless of the instrument. SME1203-1 will respond to the following bus commands.

### ■ ABORT I/O (IFC)

ABORT I/O (IFC control line TRUE) halts all bus activity and deselects the SME1203-1.

### ■ DEVICE CLEAR (SDC or DCL)

This command can be used with an address to clear a particular device (SDC: selected device clear) or used without an address (DCL: clears all devices). The Input buffer is cleared, output data buffer is cleared and bit 4 (MAV bit) of the status byte is set to "0", when SME1203-1 receives this command.

### ■ LOCAL (GTL)

LOCAL returns control of a listening device to front panel control.

### ■ LOCAL LOCKOUT (LLO)

LOCAL LOCKOUT disables the LOCAL operation of all devices on the bus. After this command is sent you will be unable to operate SME1203-1 from the front panel include the softkey LOCAL. Execute the LOCAL command to undo LOCAL LOCKOUT.

### ■ REMOTE

REMOTE sets SME1203-1 to the remote mode. When this command is sent, front

with the exception of LOCAL softkey will be disabled.

■ **TRIGGER (GET)**

This command is used to trigger the SME1203-1 and SME1203-1 will send tested waveform data to the output buffer. This command may be sent to a selected device or to all devices addressed as listeners on the GPIB bus. SME1203-1 must first be addressed as a listener, second the trigger mode is set to the BUS before the trigger message is sent out. This command is equal to the command TRIG + FETCh:TWAVE? or the common command \*TRG.

**6.3 Waveform Data Format**

SME1203-1 outputs the waveform data using the ASCII via the GPIB bus. The format is described as follows.

```
<DATA[1][0]><DATA[1][1]><DATA[2][0]><DATA[2][1]><DATA[3][0]><DATA[3][1] .....  
<DATA[960][0]> <DATA[960][1]> → <NL^END>
```

**Figure 6-6 Data Format**

In Figure 6-6, <NL> is New Line character (decimal 10), ^END is EOI terminator signal. If waveform data is ready, SME1203-1 sends out waveform data in ASCII string with <NL ^END> as the terminal character, otherwise SME1203-1 returns <NL ^END> directly.

Each point data of a waveform (HEX format, from 0x00 to 0xFF) is divided as two ASCII codes. SME1203-1 sends the two ASCII codes, the first output ASCII code is the 4 high bits and the second output ASCII code is the 4 low bits. Controller should compose the two ASCII codes as one HEX data for displaying and calculating.

For example:

When HEX data 0Xab is to be sent, it will be divided into two ASCII codes as follows:

<DATA[n][0]> = 0X0a

<DATA[n][1]> = 0X0b

# Chapter 7 Handler Interface

## 7.1 Basic Information

The handler interface employs a DB9 connector as shown in Figure 7-1.



**Figure 7-1 Handler Interface**

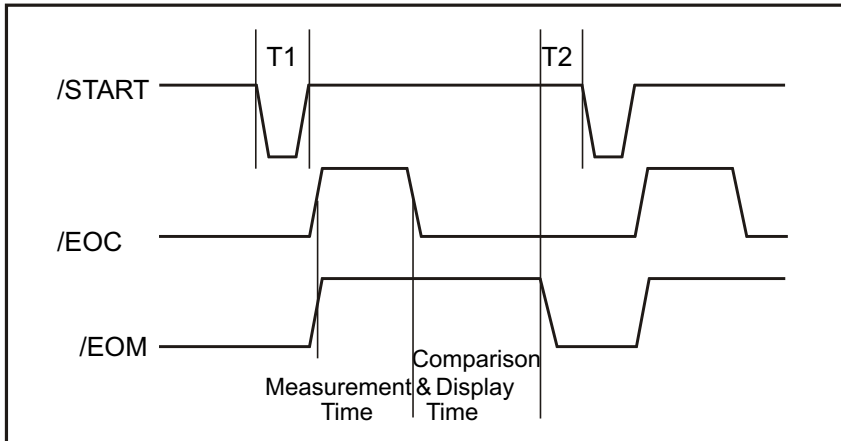
The signal definitions for each pin are described as follows.

**NOTE:** *The / (back slash) in the signal name means that the signal is asserted when low.*

<b>PIN1</b>	<b>EXGND</b>	Common for external voltage source EXV. When SME1203-1 uses the internal voltage as the power supply for handler interface, SME1203-1's circuit common will be connected to EXGND.
<b>PIN2</b>	<b>/EOC</b>	End of conversion /EOC signal is asserted when the A/D conversion is completed and SME1203-1 is ready for the next DUT to be connected to the test terminals. The measurement data, however, is not valid until BUSY is asserted to low.
<b>PIN3</b>	<b>/EOM</b>	End of Measurement /EOM signal is asserted when calculation, comparison and display are all completed.
<b>PIN4</b>	<b>/PASS</b>	Pass signal output.
<b>PIN5</b>	<b>/FAIL</b>	Fail signal output.
<b>PIN6</b>	<b>EXV</b>	External DC voltage. DC voltage supply pins for DC isolated open collector outputs, /EOC, /START, /STOP, /PASS, /FAIL, /EOM. The setting of internal jumpers must be changed when using the internal voltage supply.
<b>PIN7</b>	<b>/START</b>	External Trigger Signal. SME1203-1 is triggered on the rising edge of a pulse applied to this pin when the trigger mode is set to EXT mode.
<b>PIN8</b>	<b>/STOP</b>	External Stop Signal. Test is interrupted on the rising edge of a pulse applied to this pin.
<b>PIN9</b>	<b>VCC</b>	Internal voltage source supply (maximum 100 mA).

The timing diagram for handler interface is displayed in Figure 7-2, T1 is the trigger pulse width and

The minimum pulse width is 1  $\mu$ s. T2 is the delay time after the foregoing measurement completed to next trigger signal, its minimum pulse width is 0  $\mu$ s. /PASS and /FAIL signal are asserted after the measurement completed, till next trigger. The request of the /STOP pulse signal is the same as /START pulse signal.



**Figure 7-2 Timing Diagram for Handler Interface**

## 7.2 Electrical Characteristics

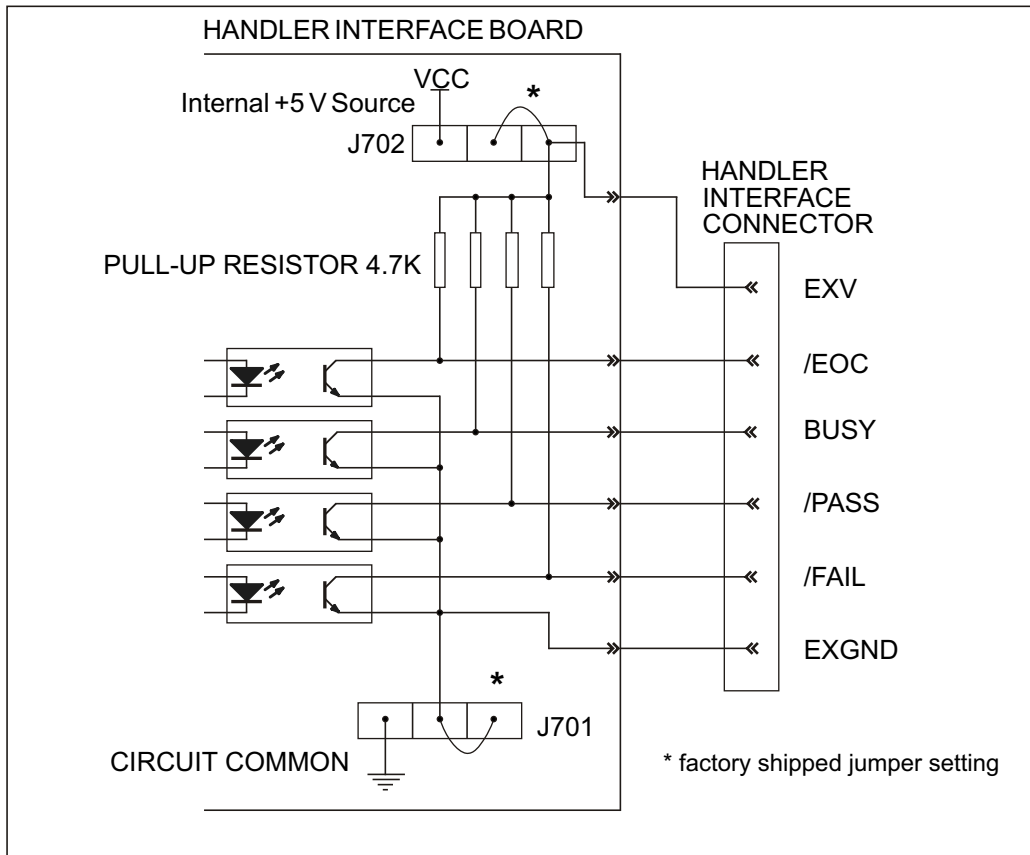
### 7.2.1 DC Isolated Outputs

Each DC output (pins 2 through 5) is isolated using an open collector output opto-coupler. The output voltage of each line is set by a pull-up resistor on the handler interface board. The pull-up resistors can be connected to the internally supplied voltage (+5 V), or to an externally applied voltage (EXV: +5 V to +24 V) by setting jumpers. Table 7-1 shows the electrical characteristics of the DC isolated outputs.

**Table 7-1 DC Isolated Output Electrical Characteristics**

Output Signals	Voltage Output Rating		Maximum Current	Circuit Common
	Low	High		
/EOC /EOM /PASS /FAIL	$\leq 0.5$ V	+ 5 V to + 24 V	6 mA	Internal pull-up voltage: SME1203-1 circuit common (GND)  External voltage (EXV): EXGND

A simplified diagram of the output signals is shown in Figure 7-3. \* is the default jumper setting when shipped from factory.

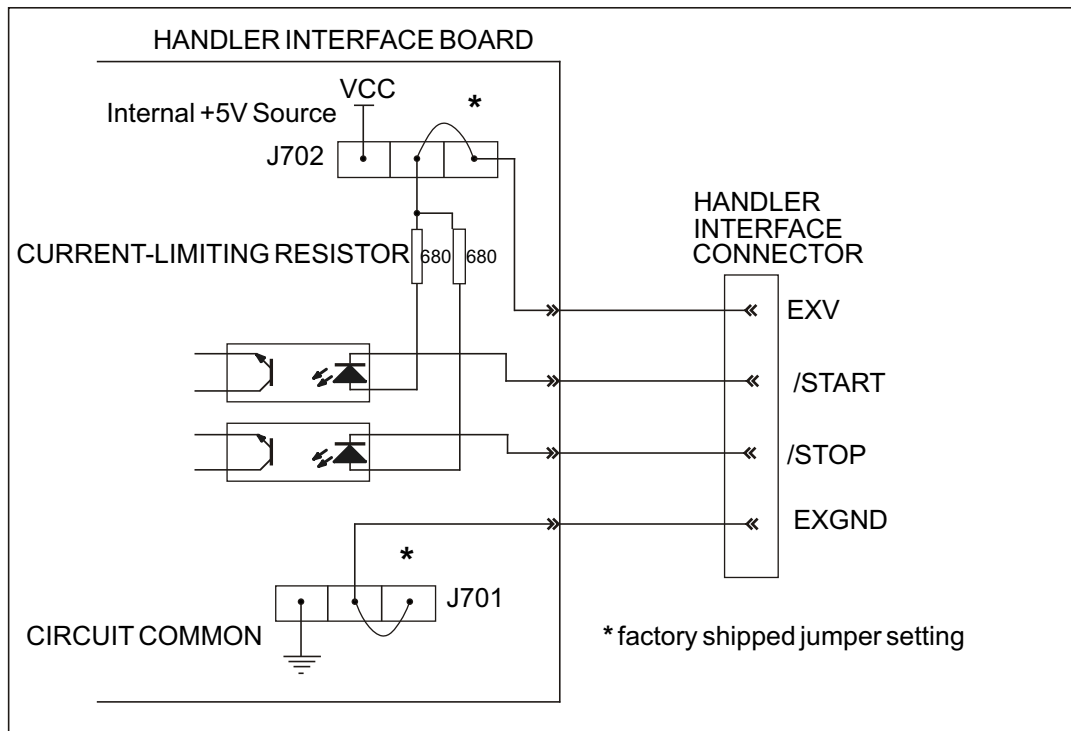


**Figure 7-3 Simplified Diagram of the Output Signals**

### 7.2.2 DC Isolated Input

The /START signal (pin 7) and /STOP signal (pin 8) are connected to the cathode of the LED in an opto-coupler. SME1203-1 is triggered on the rising edge of the /START pulse and stopped on the rising edge of the /STOP pulse. The anode of the LED can be connected to the internal +5 V, or an external voltage source EXV (the same external voltage source used for output signal).

A simplified diagram of the input signals is shown in Figure 7-4.



**Figure 7-4 Simplified Diagram of the Input Signals**

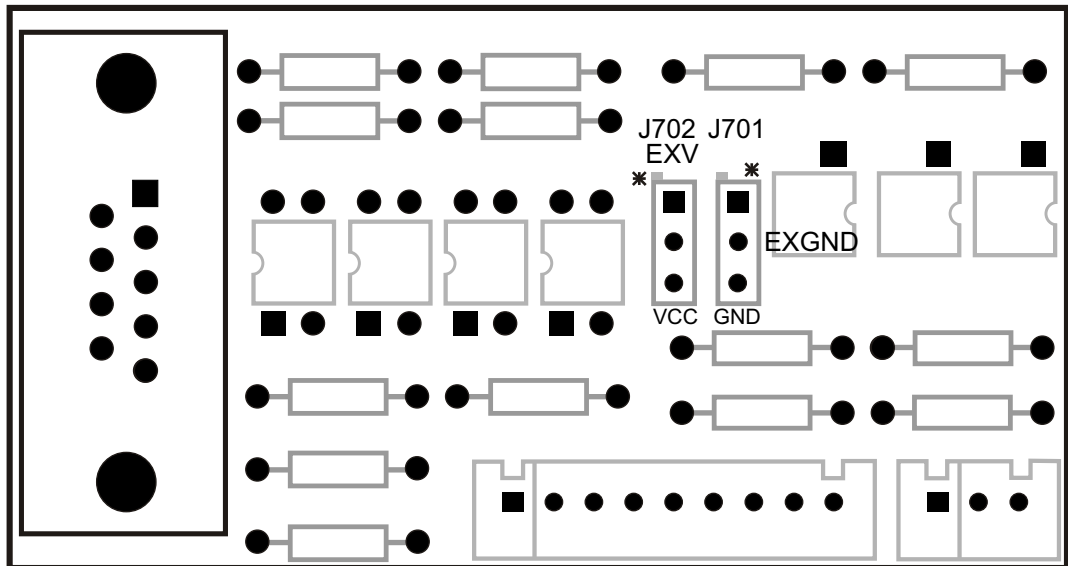
In the Figure 7-4, the default jumper setting is to use external voltage source. Actually, the input signals and output signals use the same external voltage source together. The CURRENT-LIMITING RESISTOR is used to limit current and the default resistor is only suitable for external voltage source range from 5 V to 8 V. If the external voltage source is higher than 8 V, you should replace the CURRENT-LIMITING RESISTOR to avoid damaging circuit components. Current-limiting resistors R712 and R713 should be both replaced. The detailed replacement information about CURRENT-LIMITING RESISTOR is listed in Table 7-2.

**Table 7-2 Current Limiting Resistors for Different Voltages**

CURRENT-LIMITING RESISTOR	Range of external voltage source
680 $\Omega$	5 V to 8 V
1.2 k $\Omega$	8 V to 15 V
2.2 k $\Omega$	15 V to 24 V

### 7.3 Setting Up the Handler Interface Board

There are two jumpers on the Handler Interface Board. The two jumpers are used to select the internal voltage source or external voltage source for the output signal and input signal. Their locations are shown in Figure 7-5.



**Figure 7-5 Jumper Position on the Handler Interface Board**

When shipped from the factory, each jumper is set to the (\*) position. If you want to set the jumper, you must set both the jumpers. So in the Figure 7-5, the two jumpers can be set at the upper position or lower position at the same time.

# Chapter 8 SCPI Command Reference

This chapter provides descriptions of all SME1203-1's available GPIB commands which correspond to Standard Commands for Programmable Instruments (SCPI) command sets. Use this section as a reference.

## 8.1 Command structure

SME1203-1's commands are divided into two types: GPIB common commands and SCPI commands. The GPIB common commands are defined in IEEE std. 488.2-1987, and these commands are common for all devices. Not all GPIB commands are supported by the SME1203-1. The SCPI commands are used to control all of the SME1203-1's functions. The SCPI commands are tree structured three levels deep. (The highest level commands are called the subsystem commands in this manual.) So the lower level commands are legal only when the subsystem commands have been selected. A colon (:) is used to separate the higher level commands and the lower level commands. See Figure 8-1 for a sample.

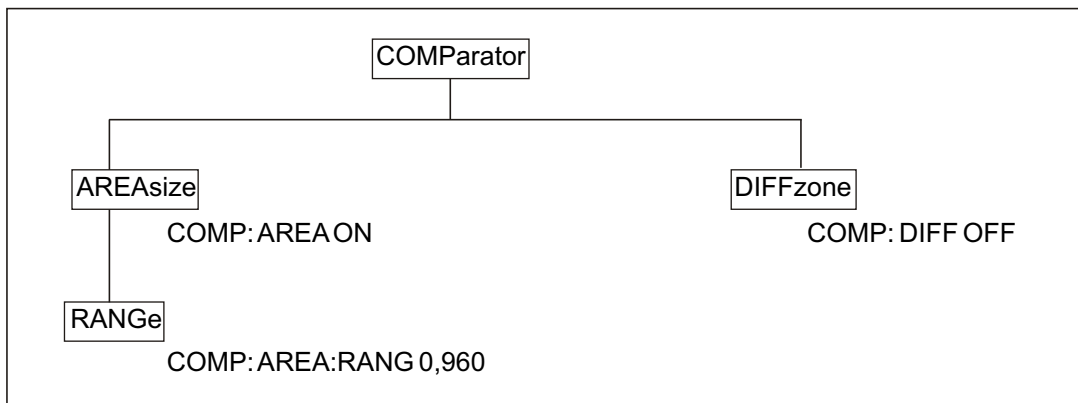


Figure 8-1 Command Tree Example

## 8.2 Command Syntax

The information in this section covers the syntax for both common commands and SCPI commands.

### 8.2.1 Notation Conventions and Definitions

1) The following characters are used in the command syntax.

- : A colon is used to separate the higher level commands and the lower level commands.
- ; The semicolon can be used as a separator to execute multiple commands on a single line.
- \* Asterisk is used to indicate that the command followed is a common command.
- ? A question mark is used to generate a query for the command in front of it.
- ,
- White space is used to separate the command and the parameter.
- "" Double quotation marks indicate that the enclosed text is string data.



2) The following characters will be used in this chapter to describe GPIB commands.

- NR1 Integer numeric data. For example: 123
- NR2 Fixed point numeric data. For example: 12.3
- NR3 Floating point numeric data. For example: 12.3E+5
- NL New Line character (decimal 10) is the end of the input/output string.
- ^END EOI terminator signal
- <> Angular brackets enclose words or characters that are used to symbolize a program code parameter or a GPIB command.
- [] Square brackets indicate that the enclosed items are optional.
- { } When several items are enclosed by braces, one and only one of these elements may be selected.

### 8.2.2 Short-form Rules

Every command and character parameter has at least two forms, a short form and a long form. In some cases they will be the same. The short form is obtained using the following rules.

- If the long form has more than 4 characters, and if the 4th character is a vowel, the short form is the first 3 characters of the long form. If the 4th character is not a vowel, the short form is the first 4 characters.

For example: TIME abbreviates to TIME.  
TRIGger abbreviates to TRIG.  
DELeTe abbreviates to DEL.  
FREQUency abbreviates to FREQ.

- If the long form mnemonic is defined as a phrase rather than a single word, then the long form mnemonic is the first character of the first word(s) followed by the entire last word. The above rules, when the long form mnemonic is a single word, are then applied to the resulting long form mnemonic to obtain the short form.

For example: Mass MEMory abbreviates to MMEM (long form is MMEMory)  
Impulse VOLTage abbreviates to IVOLT(long form is IVOLTage)

### 8.2.3 Basic Rules of Command Structure

- Letter case (upper and lower) is ignored.  
For example: COMP:AREA ON = comp:area on = Comp:aRea On
- Spaces (␣ indicate a space) must not be placed before and/or after a colon (:).  
For example:  
Wrong : COMP␣:␣ AREA ON  
Right: COMP: AREA ON
- Space is used to partition off command and parameter.  
For example: COMP: AREA␣ON AREA is command and ON is parameter.
- Some commands have no parameter.  
For example: TRIG
- The command can be completely spelled out or in abbreviated type.  
(The rules for command abbreviation are described later in this section, abbreviation is spelling

out in upper letter case)

For example: COMP:AREASIZE ON = COMP:AREA ON

- The command header should be followed by a question mark (?) to generate a query for that command.

For example: COMP:AREA?

### 8.2.4 Multiple Command Rules

The semicolon (;) can be used as a separator to execute multiple commands on a single line.

The multiple command rules are as follows.

- Commands at the same level and in the same subsystem command group can be separated by a semicolon (;) on a multiple command line.

For example: COMP:AREA:STAT ON;RANG 0,960

- To restart commands from the highest level, a semicolon (;) must be used as the separator, and then a leading colon (:), which shows that the restarted command is a command at the top of the command tree, must follow.

For example: COMP:AREA:STAT ON;;COMP:AREA:RANG 0,960

- The GPIB common commands can be placed in previous, middle or last on a multiple command line, partitioned off with semicolons.

For example: COMP:AREA ON;\*trg;DIFF ON

### 8.2.5 Command Path Rules

- Each new program message must begin with the root command, unless it is optional (e.g., [:SENSe]). If the root is optional, simply treat a command word on the next level as the root.

- The colon at the beginning of a program message is optional and need not be used.

Example:

:DISPlay:ENABLE <b> = DISPlay:ENABLE <b>

- When the path pointer detects a colon(;), it moves down to the next command level.
- When the path pointer detects a colon(:) after a semicolon (;), it resets back to the root level.
- The path pointer can only move down. It cannot be moved up a level. Executing a command at a higher level requires that you start over at the root command.

## 8.3 Command Reference

All commands in this reference are fully explained and listed in the following functional command order.

### SME1203-1 Subsystem Commands

- |              |                |                  |
|--------------|----------------|------------------|
| •DISPlay     | •COMParator    | •Impulse VOLTage |
| •Sample RATE | •Standard WAVE | •STATistic       |
| •TRIGger     | •FETCh?        | •MEASure         |
| •ABORt       | •Mass MEMORy   |                  |

### GPIB Common Commands

- |       |       |       |
|-------|-------|-------|
| •*RST | •*TRG | •*IDN |
|-------|-------|-------|

### 8.3.1 DISPlay Subsystem

The DISPlay subsystem command group sets the display page. Figure 8-2 shows the command tree of the DISPlay Subsystem Command Tree.

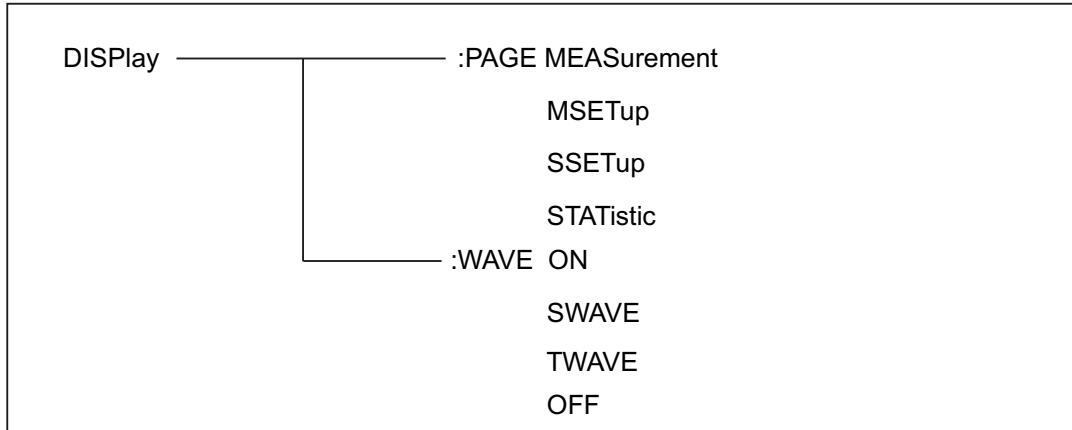


Figure 8-2 Display Subsystem Command Tree

#### :PAGE

The :PAGE command sets the display page. The :PAGE? query returns the abbreviated page name currently displayed on the LCD screen.

#### Command Syntax

DISPlay:PAGE <page name>

Where, <page name> is:

MEASurement	Sets display page to Measurement Display page
MSETup	Sets display page to Measurement Setup page
SSETup	Sets display page to System Setup page
STATistic	Sets display page to Statistic Display page

#### Example

WrtCmd("DISP:PAGE MEAS") Set display page to the **Measurement Display** page.

#### Query Syntax

DISPlay:PAGE?

#### Query Response

Returned data format is : <page name><NL^END>

Where, <page name> return the abbreviated name of the current display page as shown below.

<MEAS DISP>	Current displaying page is Measurement Display page
< MEAS SETUP>	Current displaying page is Measurement Setup page
<SYSTEM SETUP>	Current displaying page is System Setup page
<STAT. DISP>	Current displaying page is Statistic Display page

## **:WAVE**

The :WAVE command sets the waveform display mode. The WAVE? query returns the current waveform display mode.

### **Command Syntax**

DISPlay:WAVE { ON  
SWAVE  
TWAVE  
OFF }

Where,

ON Display both the standard and the tested waveforms on the LED screen.

SWAVE Only display the standard waveform on the LCD screen.

TWAVE Only display the tested waveform on the LCD screen.

OFF No waveform will be displayed.

### **Example**

WrtCmd("DISP:WAVE SWAVE" ) Set to display standard waveform only.

### **Query Syntax**

DISPlay:WAVE?

### **Query Response**

{ ALL ON  
ONLY STDWAVE  
ONLY TESTWAVE  
ALL OFF } <NL^END>

A string is returned to indicate the waveform display mode.

### 8.3.2 COMParator Subsystem

The COMParator subsystem command group sets the comparison functions including AREA SIZE,DIFF ZONE, CORONA and PHASE DIFF. Figure 8-3 shows the command tree of the COMParator subsystem command group.

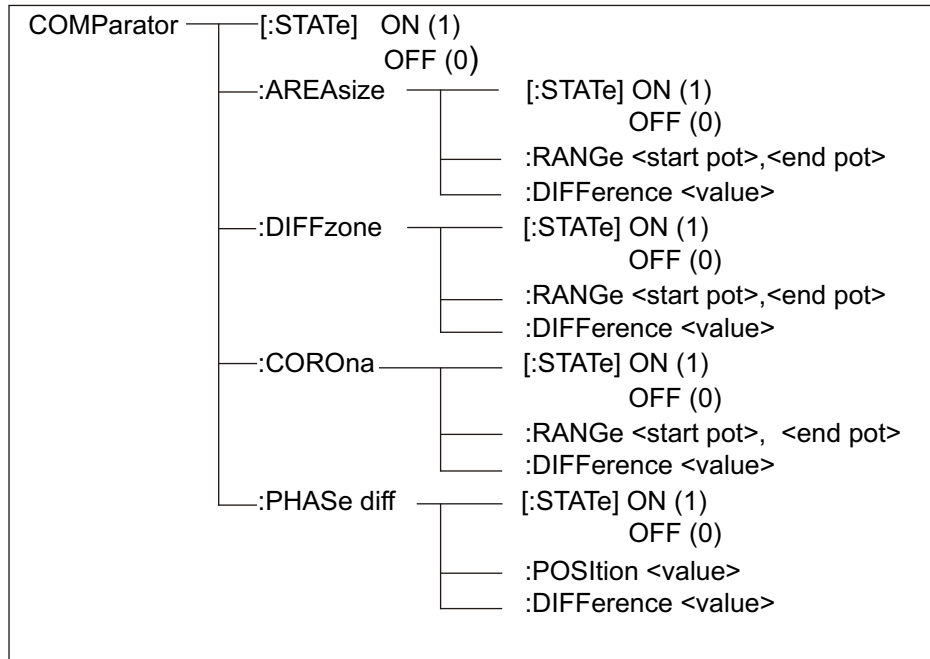


Figure 8-3 COMParator Subsystem Command Tree

#### [:STATe]

The [:STATe] command sets the comparator to ON or OFF. The [:STATe]? query returns the current comparator ON/OFF state.

#### Command Syntax

$$\text{COMParator[:STATe]} \left\{ \begin{array}{l} \text{ON} \\ \text{OFF} \\ 1 \\ 0 \end{array} \right\}$$

Where,

- 1 (decimal 49)      When the function is ON
- 0 (decimal 48)      When the function is OFF

#### Example

WrtCmd("COMP ON")      Set the comparator to ON.

#### Query Syntax

COMParator[:STATe]?

#### Query Response

<NR1><NL^END>

### **:AREAsize[:STATe]**

The :AREAsize[:STATe] command sets the AREA SIZE comparator to ON or OFF.

The :AREAsize[:STATe]? query returns the current AREA SIZE comparator ON/OFF state.

#### **Command Syntax**

COMParator:AREAsize[:STATe]  $\left\{ \begin{array}{l} \text{ON} \\ \text{OFF} \\ 1 \\ 0 \end{array} \right\}$

Where,

1 (decimal 49)      When the function is ON

0 (decimal 48)      When the function is OFF

#### **Example**

WrtCmd("COMP:AREA ON")      Set AREA SIZE comparator to ON.

#### **Query Syntax**

COMParator:AREAsize[:STATe]?

#### **Query Response**

<NR1><NL^END>

### **:AREAsize:RANGe**

The :AREAsize:RANGe command sets the comparison range of AREA SIZE comparator.

The :AREAsize:RANGe? query returns the current comparison range of AREA SIZE comparator.

#### **Command Syntax**

COMParator:AREAsize:RANGe <start pot>, <end pot>

Where,

<start pot> start point of comparison range. NR1 format, range 0 to 960, without unit.

<end pot> end point of comparison range. NR1 format, range 0 to 960, without unit.

#### **Example**

WrtCmd( "COMP:AREA:RANG 0,960 )      Set comparison range from 0 to 960

**NOTE: End point value should be larger than start point. Otherwise an error message will be displayed on the system message line.**

#### **Query Syntax**

COMP:AREA:RANG?

#### **Query Response**

<start pot>, <end pot><NL^END>

Where, <start pot> and <end pot> are NR1 format.

### **:AREAsize:DIFFerence**

The :AREAsize:DIFFerence command sets the difference limit value of AREA SIZE comparator. The :AREAsize: DIFFerence? query returns the current difference limit value of AREA SIZE comparator.

#### **Command Syntax**

COMParator: AREAsize:DIFFerence <value>

Where,

<value> Set the difference limit value. NR1 or NR2 or NR3 format, without unit.

**NOTE:** *The <value> here is a percent value. For example, Input 2.5 for 2.5%.*

#### **Example**

WrtCmd( "COMP: AREA:DIFF 2.5" ) Set difference limit value to 2.5%

#### **Query Syntax**

COMParator:AREAsize: DIFFerence?

#### **Query Response**

<NR2><NL^END>

### **:DIFFzone[:STATe]**

The :DIFFzone[:STATe] command sets the DIFF ZONE comparator to ON or OFF.

The :DIFFzone[:STATe]? Query returns the current DIFF ZONE comparator ON/OFF state.

#### **Command Syntax**

COMParator:DIFFzone[:STATe]  $\left\{ \begin{array}{l} \text{ON} \\ \text{OFF} \\ 1 \\ 0 \end{array} \right\}$

Where,

1 (decimal 49) When the function is ON

0 (decimal 48) When the function is OFF

#### **Example**

WrtCmd("COMP:DIFF ON") Set DIFF ZONE comparator to ON.

#### **Query Syntax**

COMParator:DIFFzone[:STATe]?

#### **Query Response**

<NR1><NL^END>

### **:DIFFzone:RANGe**

The :DIFFzone:RANGe command sets the comparison range of DIFF ZONE comparator.

The :DIFFzone:RANGe? query returns the current comparison range of DIFF ZONE comparator.

#### **Command Syntax**

COMParator:DIFFzone:RANGe <start pot>, <end pot>

Where,

<start pot> start point of comparison range. NR1 format, range 0 to 960, no unit.

<end pot> end point of comparison range. NR1 format, range 0 to 960, no unit.

**Example**

WrtCmd( "COMP:DIFF:RANG 0,960 ):            set comparison range from 0 to 960

**NOTE:** *End point value should be larger than start point. Otherwise an error message will be displayed on the system message line.*

**Query Syntax**

COMP:DIFF:RANG?

**Query Response**

<start pot>, <end pot><NL^END>

Where, <start pot> and <end pot> are NR1 formats.

**:DIFFzone:DIFFerence**

The :DIFFzone:DIFFerence command sets the difference limit value of DIFF ZONE comparator. The :DIFFzone:DIFFerence? query returns the current difference limit value of DIFF ZONE comparator.

**Command Syntax**

COMParator:DIFFzone:DIFFerence <value>

Where,

<Value> Set the difference limit value. NR1 or NR2 or NR3 format, no unit.

**NOTE:** *Here <value> is a percent value. For example, Input 2.5 for 2.5%.*

**Example**

WrtCmd( "COMP:DIFF:DIFF 2.5" ) Set difference limit value to 2.5%

**Query Syntax**

COMParator:DIFFzone:DIFFerence?

**Query Response**

<NR2><NL^END>

**:COROna[:STATe]**

The :COROna[:STATe] command sets the CORONA comparator to ON or OFF.

The :COROna[:STATe]? query returns the current CORONA comparator ON/OFF state.

**Command Syntax**

COMParator:COROna[:STATe]  $\left\{ \begin{array}{l} \text{ON} \\ \text{OFF} \\ 1 \\ 0 \end{array} \right\}$

Where,

1 (decimal 49)            When the function is ON



0 (decimal 48)      When the function is OFF

**Example**

WrtCmd("COMP:CORO ON")    Set CORONA comparator to ON.

**Query Syntax**

COMParator:CORO[:STATe]?

**Query Response**

<NR1><NL^END>

**:COROna:RANGe**

The :COROna:RANGe command sets the comparison range of CORONA comparator.

The :COROna:RANGe? query returns the current comparison range of CORONA comparator.

**Command Syntax**

COMParator:COROna:RANGe <start pot>, <end pot>

Where,

<start pot> start point of comparison range. NR1 format, range 0 to 960, no unit.

<end pot> end point of comparison range. NR1 format, range 0 to 960, no unit.

**Example**

WrtCmd( "COMP:CORO:RANG 100,300 )    Set comparison range from 100 to 300

**NOTE: End point value should be larger than start point. Otherwise an error message will be displayed on the LCD screen.**

**Query Syntax**

COMP:CORO:RANG?

**Query Response**

<start pot>, <end pot><NL^END>

Where, <start pot> and <end pot> is NR1 format.

**:COROna:DIFFerence**

The :COROna:DIFFerence command sets the difference limit value of CORONA comparator.

The :COROna:DIFFerence? query returns the current difference limit value of CORONA comparator.

**Command Syntax**

COMParator:COROna:DIFFerence <value>

Where,

<value> is the difference limit value. NR1 format, without unit.

**Example**

WrtCmd( "COMP:CORO:DIFF 20" )    Set difference limit value to 20

**Query Syntax**

COMParator:COROna:DIFFerence?

### Query Response

<NR1><NL^END>

### :PHASediff[:STATe]

The :PHASediff[:STATe] command sets the PHASE DIFF comparator to ON or OFF.

The :PHASediff[:STATe]? query returns the current PHASE DIFF comparator ON/OFF state.

### Command Syntax

$$\text{COMParator:PHASediff[:STATe]} \left\{ \begin{array}{l} \text{ON} \\ \text{OFF} \\ 1 \\ 0 \end{array} \right\}$$

Where,

1 (decimal 49)      When the function is ON

0 (decimal 48)      When the function is OFF

### Example

WrtCmd("COMP:PHAS ON")    Set PHASE DIFF comparator to ON.

### Query Syntax

COMParator:PHAS[:STATe]?

### Query Response

<NR1><NL^END>

### :PHASediff:POSItion

The :PHASediff:POSItion command sets which zero-crossing point is used in PHASE DIFF comparator. The : PHASediff:POSItion? query returns the zero-crossing position value of PHASE DIFF comparator.

### Command Syntax

COMParator:PHASediff:POSItion <value>

Where,

<Value> Zero-crossing position value. NR1 format, range 2 to 10, without unit.

### Example

WrtCmd( "COMP:PHAS:POSI 3 )    Set the third zero-crossing point.

### Query Syntax

COMP:PHAS:POSI?

### Query Response

<NR1><NL^END>

### : PHASediff:DIFFerence

The :PHASediff:DIFFerence command sets the difference limit value of PHASE DIFF comparator.

The :PHASediff:DIFFerence? query returns the current difference limit value of PHASE DIFF comparator.

### Command Syntax

COMParator:PHASediff:DIFFerence <value>

Where,

<value> May be NR1 or NR2 or NR3 format, no unit.

**NOTE: Here <value> is a percent value. For example, Input 2.5 for 2.5%.**

### Example

WrtCmd( "COMP:PHAS:DIFF 2.5" ) Set difference limit value to 2.5

### Query Syntax

COMParator: PHASe diff: DIFFerence?

### Query Response

<NR2><NL^END>

### 8.3.3 Impulse VOLTage Subsystem

The Impulse VOLTage Subsystem command group sets the impulse voltage, average times, impulse voltage auto adjust and delay etc. Figure 8-4 shows the Impulse VOLTage Subsystem command Tree.

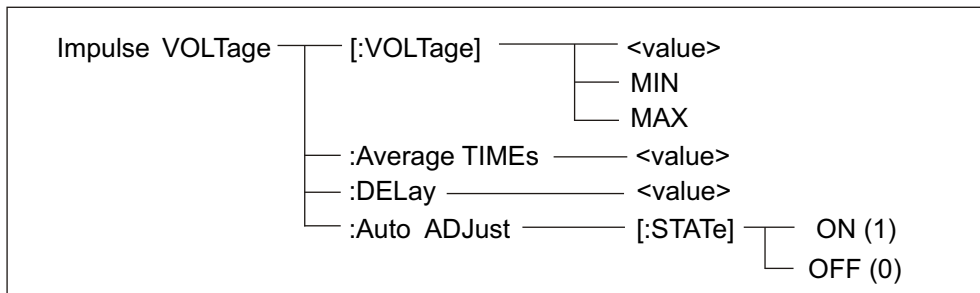


Figure 8-4 Impulse VOLTage Subsystem command Tree

### [:VOLTage]

The [:VOLTage] command sets the impulse voltage for testing. The [:VOLTage]? Query returns the current impulse voltage value.

### Command Syntax

IVOLTage[:VOLTage] { <value> }  
                                  { MIN }  
                                  { MAX }

Where,

<value> NR1, NR2, or NR3 format followed by KV or V, the value must be between 300 V to 3000 V(SME1203-1).

MIN Set the impulse voltage to 300 V (SME1203-1).

MAX Set the impulse voltage to 3000 V (SME1203-1).

**Example**

WrtCmd( "IVOLT:VOLT 1000 V" )    Set impulse voltage to 1000 V.

**Query Syntax**

IVOLTage:[VOLTage]?

**Query Response**

<NR1><NL^END>

**:Average TIMEs**

The :Average TIMEs command sets the averaging rate. The :Average TIMEs? query returns the current averaging rate.

**Command Syntax**

IVOLTage:ATIMEs <value>

Where,

<value>    is NR1 format, range from 1 to 30, no unit.

**Example**

WrtCmd( "IVOLT:ATIME 2" )    Set the averaging rate to 2

**Query Syntax**

IVOLTage:ATIMEs?

**Query Response**

<NR1><NL^END>

**:DElay**

The :DElay command sets the delay time between two measurement when trigger mode is set to INTernal mode. The :DElay? query returns the current delay time.

**Command Syntax**

IVOLTage:DElay <value>

Where,

<value>    May be NR1, NR2 or NR3 format followed by s or ms, the value must be from 0 to 99.9s.

**Example**

WrtCmd( "IVOLT:DEL 1s" )    Set the delay time to 1s when trigger mode is INTernal mode.

**Query Syntax**

IVOLTage:DElay?

**Query Response**

<NR2><NL^END>

**:Auto ADJust**

The :Auto ADJust command sets the impulse voltage auto adjust to ON or OFF. The :Auto ADJust? query returns the current impulse voltage auto adjust ON/OFF state.

### Command Syntax

IVOLTage:AADJust  $\left\{ \begin{array}{l} \text{ON} \\ \text{OFF} \\ 1 \\ 0 \end{array} \right\}$

Where,

1 (decimal 49)      When the function is ON  
0 (decimal 48)      When the function is OFF

### Example

WrtCmd( "IVOLT:AADJ OFF" )      Set the impulse voltage auto adjust to OFF.

### Query Syntax

IVOLTage:AADJust?

### Query Response

<NR1><NL^END>

## 8.3.4 Sample RATE Subsystem

The Sample RATE Subsystem command group sets the sample rate and time base zoom. Figure 8-5 shows the Sample RATE Subsystem Command Tree.

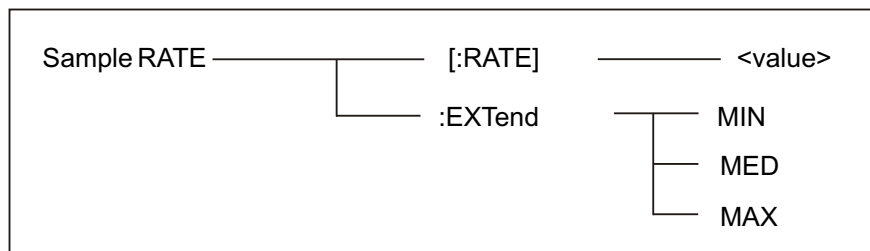


Figure 8-5 Sample RATE Subsystem Command Tree

### [:RATE]

The [:RATE] command sets the sample rate. The [:RATE]? query returns the current sample rate setting.

### Command Syntax

SRATE[:RATE] <value>

Where,

<value>      The available values are listed as follows

40/01msps, 40/02msps, 40/04msps, 40/08msps, 40/16msps, 40/32msps, 40/64msps,  
40/128msps

40/01, 40/02, 40/04, 40/08, 40/16, 40/32, 40/64, 40/128

### Example

WrtCmd( "SRATE:RATE 40/02msps" )      Set the sample rate to 40/02MSPS.

**NOTE:** When SME1203-1 is not in the test state, SRATE[:RATE] command changes the current sample rate. When SME1203-1 is in the test state, this command will be ignored.

**Query Syntax**

SRATE[:RATE]?

**Query Response**

{ 40/01 MSPS  
40/02 MSPS  
40/04 MSPS  
40/08 MSPS  
40/16 MSPS  
40/32 MSPS  
40/64 MSPS  
40/128 MSPS } <NL^END>

**:EXTend**

The :EXTend command sets the time base zoom function. The :EXTend? query returns the current time base zoom value.

**Command Syntax**

SRATE:EXTend { MIN  
MED  
MAX }

Where,

MIN Set to display waveform with the all 960 points data.

MED Set to display waveform with the front 480 points data.

MAX Set to display waveform with the front 240 points data.

**Example**

WrtCmd( "SRATE:EXT MIN" )

**NOTE:** This command will be ignored when SME1203-1 is in the testing state.

**Query Syntax**

SRATE:EXTend?

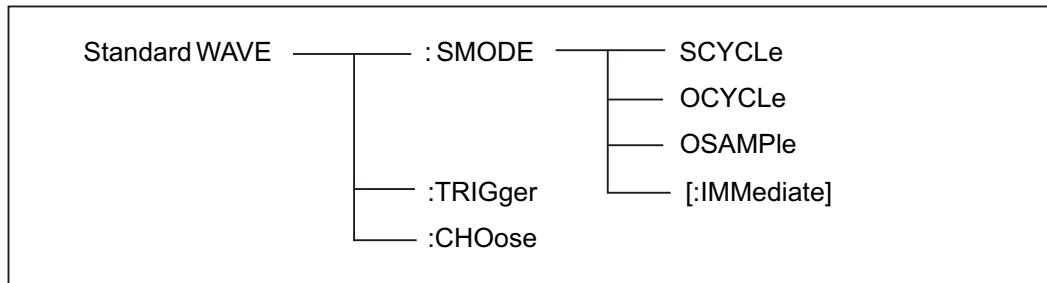
**Query Response**

{ MIN  
MED  
MAX } <NL^END>

**8.3.5 Standard WAVE Subsystem**

The Standard WAVE Subsystem command group sets the parameters for sampling the standard waveform, including setting the standard waveform sample mode, triggering the measurement of a standard waveform and choosing a sampled standard waveform.

Figure 8-6 shows the Standard WAVE Subsystem Command Tree.



**Figure 8-6 Standard WAVE Subsystem Command Tree**

### **:SMODE**

The :SMODE command sets the standard waveform sample mode. The :SMODE? Query returns the current standard waveform sample mode.

#### **Command Syntax**

$$\text{SWAVE:SMODE} \left\{ \begin{array}{l} \text{SCYCLe} \\ \text{OCYCLe} \\ \text{OSAMPle} \end{array} \right\}$$

Where,

- SCYCLe            Set the standard waveform sample mode to sequence-cycle.
- OCYCLe           Set the standard waveform sample mode to one-cycle.
- OSAMPle           Set the standard waveform sample mode to one-sample.

#### **Example**

WrtCmd( "SWAVE:SMODE OSAMPle" )

#### **Query Syntax**

SWAVE:SMODE?

#### **Query Response**

$$\left\{ \begin{array}{l} \text{SEQCYCLE} \\ \text{ONE CYCLE} \\ \text{ONESAMPLE} \end{array} \right\} \langle \text{NL}^{\wedge} \text{END} \rangle$$

### **:TRIGger[:IMMediate]**

The :TRIGger[:IMMediate] command is used to start sampling of the standard waveform.

#### **Command Syntax**

SWAVE:TRIGger[:IMMediate]

#### **Example**

WrtCmd( "SWAVE:TRIG" ): □

**NOTE: 1. This command is available only on the <MEAS DISP> page.**

**2. This command will be ignored if the trigger mode is not set to BUS mode.**

3. This command will be ignored when SME1203-1 is in testing state.

**NOTE:** The `:TRIGger[:IMMEDIATE]` command starts a measurement of standard waveform and SME1203-1 returns the standard waveform data directly without receiving the `FETCh SWAVE?` command. In `SEQ CYCLE` mode, SME1203-1 returns standard waveform data when each sampling test is completed. In `ONE CYCLE` mode, SME1203-1 returns the last standard waveform, and returns the standard waveform when sample rate is changed.

#### :CHOose

The `:CHOose` command is used to choose the standard waveform data.

#### Command Syntax

SWAVE:CHOose

#### Example

WrtCmd( "SWAVE:CHO" );

**NOTE:** 1. This command is available only on `<MEAS DISP>` page.  
2. This command is valid only when sampling test is finished in `SEQ CYCLE` mode or `ONE CYCLE` mode.

### 8.3.6 STATistic Subsystem

The `STATistic` Subsystem command group sets the statistic function to ON or OFF, and clear or save statistic data. Figure 8-7 shows the `STATistic` Subsystem Command Tree.

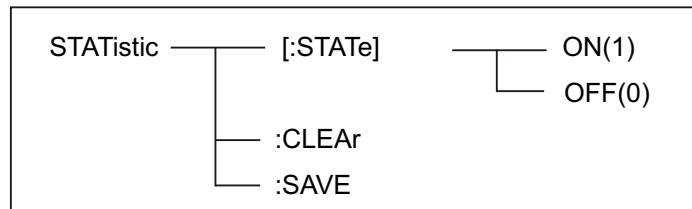


Figure 8-7 `STATistic` Subsystem Command Tree

#### [:STATe]

The `[:STATe]` command sets the statistic function to ON or OFF. The `[:STATe]?` query returns the current statistic function ON/OFF state.

#### Command Syntax

`STATistic[:STATe]` { ON  
OFF  
1  
0 }



Where,

1 (decimal 49)      When the function is ON

0 (decimal 48)      When the function is OFF

### Query Syntax

STATistic[:STATe]?

### Query Response

<NR1><NL^END>

### :CLEAR

The :CLEAR command clears the statistic data.

### Command Syntax

STATistic:CLEAR

### :SAVE

The :SAVE command saves the statistic data to a file.

### Command Syntax

STATistic:SAVE

## 8.3.7 TRIGger Subsystem

The TRIGger Subsystem command group is used to trigger a measurement or to set the trigger mode. Figure 8-8 shows the TRIGger Subsystem Tree.

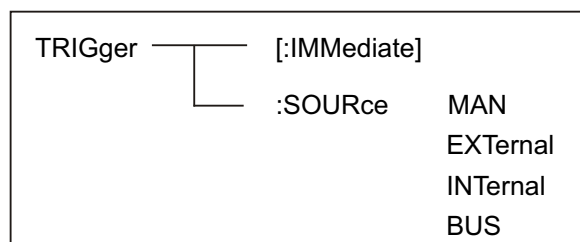


Figure 8-8 TRIGger Subsystem Tree

### [:IMMediate]

The [:IMMediate] command triggers a measurement.

### Command Syntax

TRIGger[:IMMediate]

### Example

WrtCmd( "TRIG" );

**NOTE:** The TRIGger[:IMMsdiate] command is only available on the <MEAS DISP> page.

## **:SOURce**

The :SOURce command sets the trigger mode. The :SOURce? query returns the current trigger mode.

### **Command Syntax**

TRIGger:SOURce {  
    MAN  
    EXTernal  
    INTernal  
    BUS  
}

Where,

MAN           Manual trigger mode  
EXTernal      External trigger mode  
INTernal      Internal trigger mode  
BUS           BUS trigger mode

### **Query Syntax**

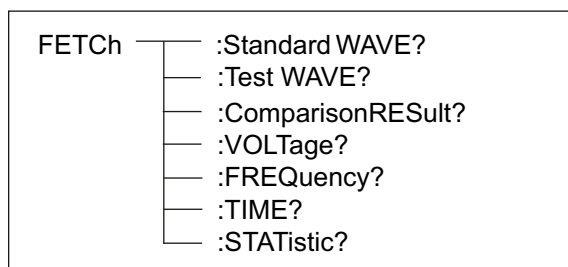
TRIGger:SOURce?

### **Query Response**

{  
  INT  
  EXT  
  BUS  
  HOLD  
} <NL^END>

## **8.7.8 FETCh? Subsystem**

The FETCh? Subsystem command group is used to output the results of measurement, including waveform data, comparison results, statistic data, time, frequency and voltage. Figure 8-9 shows the FETCh? Subsystem Command Tree.



**Figure 8-9 FETCh? Subsystem Command Tree**

## **:Standard WAVE?**

The :Standard WAVE? query put the current standard waveform date into output buffer.

### **Query Syntax**

FETCh SWAVE?

### Example

```
WrtCmd( "FETC SWAVE?" )
```

### :Test WAVE?

The :Test WAVE? query put the latest tested waveform data into output buffer.

#### Query Syntax

```
FETCh TWAVE?
```

### Example

```
WrtCmd( "TRIG:SOUR BUS" )
```

```
WrtCmd( "TRIG" )
```

```
WrtCmd( "FETC TWAVE?" )
```

**NOTE:** *If the waveform data is not ready, the FETCh SWAVE? and FETCh TWAVE? query will be executed after the current measurement or next measurement is finished.*

### Comparison RESult?

The Comparison RESult? query returns the latest comparison result.

#### Query Syntax

```
FETCh CRESult?
```

#### Query Response

- 1) If the comparator function is set to OFF, the query response will be <NR1><NL^END>, here NR1 is 2.
- 2) If there is no waveform data available, the query response will be <NR1>< NL^END>, here NR1 is 3.
- 3) If the comparator function is set to on, the query response will be ,NR3,NR1,NR3><NL^END>, the first NR1 is the general comparison result: 1 (PASS) or 0 (FAIL). The following four data are the comparison results corresponding to each comparator: AREA SIZE, DIFF ZONE, CORONA and PHASE DIFF.

**NOTE:** *SME1203-1 returns the comparison result when the comparator is turned on. SME1203-1 returns 9.9E37 when the AREA SIZE, DIFF ZONE or PHASE DIFF comparator is turned off. SME1203-1 returns 9999 when the CORONA comparator is turned off.*

### :VOLTage?

The VOLTage? query returns the current voltage value between the two voltage cursor. Refer to MEASure Subsystem about voltage cursor setting.

#### Query Syntax

```
FETCh:VOLTage?
```

### Query Response

<NR1><NL^END>

**NOTE: The default unit is V.**

### :FREQuency?

The :FREQuency? query returns the current frequency value between the two time cursor. Refer to MEASure Subsystem about time cursor setting.

### Query Syntax

FEtCh:FREQuency?

### Query Response

<NR1><NL^END>

**NOTE: The default unit is Hz. If the start cursor is overlapped with the end cursor completely, then 9.9E37 will be returned.**

### TIME?

The TIME? query returns the current time value between the two vertical cursors. Refer to MEASure Subsystem about voltage cursor setting.

### Query Syntax

FEtCh:TIME?

### Query Response

<NR1><NL^END>

**NOTE: The default unit is s.**

### :STATistic?

The :STATistic? query returns the current statistic data.

### Query Syntax

FEtCh:STATistic?

### Query Response

<NR1>,<NR1>,<NR1>,<NR1>,<NR1>,<NR1>,<NR1>,<NR1>,<NR1>,<NR1>,<NR1><NL^END>

The series of data returned is described as follows in turn:

The total tested windings and passed windings,

The tested windings and passed windings of AREA SIZE,

The tested windings and passed windings of DIFF ZONE,

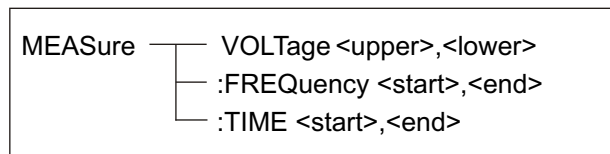
The tested windings and passed windings of CORONA,

The tested windings and passed windings of PHASE DIFF.

The passed rate can be calculated from the tested windings and passed windings.

### 8.3.9 MEASure Subsystem

The MEASure Subsystem command group sets the measurement range of voltage, frequency and time. Figure 8-10 shows the MEASure Subsystem command Tree.



**Figure 8-10 MEASure Subsystem command Tree**

#### :VOLTage

The VOLTage command sets the measurement range of voltage. The VOLTage? Query returns the current position of voltage cursor.

##### Command Syntax

MEASure:VOLTage <upper>,<lower>

Where,

<upper> is the upper cursor of voltage, NR1 format, range from 1 to 199, no unit.

<lower> is the lower cursor of voltage, NR1 format, range from 1 to 199, no unit.

##### Example

WrtCmd( "MEAS:VOLT 1,199" )

**NOTE: The lower value must be smaller than the upper value.**

##### Query Syntax

FETCH:VOLTage?

##### Query Response

<upper>,<lower><NL^END>

<upper> and <lower> are NR1 format.

#### :FREQUENCY

The :FREQUENCY command sets the measurement range of frequency. The :FREQUENCY? query returns the current position of frequency cursor.

##### Command Syntax

MEASure:FREQUENCY <start>,<end>

Where,

<start> is the start cursor of frequency, NR1 format, range from 1 to 199, no unit.

<end> is the end cursor of frequency, NR1 format, range from 1 to 199, no unit.

**NOTE: The end value must be larger than the start value.**

### Example

WrtCmd( "MEAS:FREQ 1,199" )

### Query Syntax

FEtCh:FREQuency?

### Query Response

<start>,<end><NL^END>

<start> and <end> are NR1 format.

## :TIME

The :TIME command sets the measurement range of time. The :TIME? query returns the current position of time cursor.

### Command Syntax

MEASure:TIME <start>,<end>

Where,

<start> is the start cursor of time, NR1 format, range from 1 to 199, no unit.

<end> is the end cursor of time, NR1 format, range from 1 to 199, no unit.

**NOTE:** *The end value must be larger than the start value.*

### Example

WrtCmd( "MEAS:TIME 1,199" )

### Query Syntax

FEtCh:TIME?

### Query Response

<start>,<end><NL^END>

<Start> and <end> are NR1 format.

**NOTE:** *The end value must be larger than the start value.*

## 8.3.10 ABORt Subsystem

SME1203-1 will abort the current measurement as soon as the ABORt command is received.

### Command Syntax

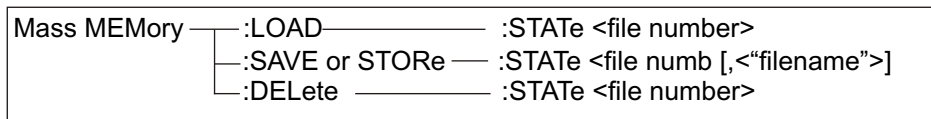
ABORt

### Example

WrtCmd("ABOR")

## 8.3.11 Mass MEMory Subsystem

The Mass MEMory subsystem command group loads or stores setting data from/to the internal EEPROM. Figure 8-11 shows the Mass MEMory Subsystem Command Tree.



**Figure 8-11 Mass MEMOrY Subsystem Command Tree**

**NOTE:** When SME1203-1 is in the test state, the Mass MEMOrY Subsystem Command will be ignored.

**:LOAD:STATe**

The :LOAD:STATe command loads the file data from the internal EEPROM.

**Command Syntax**

MMEMOrY:LOAD:STATe <file number>

Where,

<file number> 1 to 60(NR1) file number for internal EEPROM, without unit

**Example**

WrtCmd("MMEM:LOAD:STAT 1)

- NOTE:**
1. If the file you want to load is not available, "File not exist" message will be displayed on the system message line.
  2. If the input file number is out of 1 to 60, message "Out of file range" will be displayed on the system message line.
  3. The file contains the page information. When a file is loaded, SME1203-1 will display the saved page.

**:SAVE:STATe / STORe:STATe**

The :STORe:STATe or :SAVE:STATe command stores the setting data to a file in the internal EEPROM.

**Command Syntax**

MMEMOrY:STORe:STATe <file number>[,<"filename">]

Where,

<file number> 1 to 60(NR1): file number for internal EEPROM, without unit

<"Filename"> The file name consists of less than 12 characters. <Unnamed> will be the default name, if you don't input a file name.

**Example**

WrtCmd("MMEM:STOR:STAT 1, "#SME1203-1\*")

- NOTE:**
1. SME1203-1 will not give a warning message when the existent file is to be overwritten.
  2. SME1203-1 will display warning message "Test standard wave first" on the system message line when you try to save a file without the standard waveform data.

### **:DELeTeSTATe**

The DELeTe:STATe command deletes a file from the internal EEPROM.

#### **Command Syntax**

MMEMory:DELeTe:STATe <file number>

Where,

<file number> 1 to 60(NR1) : file number for internal EEPROM, no unit

#### **Example**

WrtCmd("MMEM:LOAD:STAT 1)

**NOTE:** *SME1203-1 will not give a warning message when a file is to be deleted.*

### **8.3.12 Common Commands**

A common command consists of an asterisk (\*) and a header. SME1203-1's acceptable GPIB common commands are described as follows.

#### **\*RST**

The \*RST command (reset command) sets the SME1203-1 to its initial settings.

#### **Command Syntax**

\*RST

#### **Example**

WrtCmd("\*RST")

#### **\*TRG**

The \*TRG command (trigger command) triggers a measurement and put the tested waveform data into the output buffer. This command is equal to TRIG+FETCh TWAVE? Command.

#### **Command Syntax**

\*TRG

**Note:** *This command is only available on the <MEAS DISP> pages. This command will also be ignored when SME1203-1 is in the testing state. This command is only used to trigger a measurement except for sampling a standard waveform.*

#### **Example**

WrtCmd("\*TRG")

#### **\*IDN?**

The \*IDN? query returns the SME1203-1's ID information.

#### **Query Syntax**

\*IDN?



## Query Response

<product>,<version>,<NL^END>

Where,

<product> SME1203-1 Impulse Winding Tester

<version> software revision number

## 8.4 Error and Warning Messages

The bus commands may have some spelling errors, syntax errors or wrong parameters. SME1203-1 executes a command after the command is analyzed. If one of above errors occurs, SME1203-1 halts the command analysis, and the rest commands will be ignored. If a command (for example a trigger command is ignored.) is ignored, the rest commands will be executed. The error and warning messages will be displayed on the system message line.

**Table 8-1 Error and Warning Messages**

<b>Error Message</b>	<b>Description</b>
Unknown Message!	Unknown command is received. Usually there is a spelling Error in the command. For example: <b>TRG</b> The correct command should be "TRIG".
Data Error!	Improper type of data is used or the value is out of range. For example: <b>IVOLT 50</b> The Impulse voltage can not be lower than the minimum voltage 300 V.
Error Parameter!	Unrecognizable parameter is used. For example: <b>TRIG:SOUR INTER</b> Here "INTER" is not the correct shot-form, "INT" or "INTERNAL" should be used.
Error Suffix!	Units are unrecognizable, or the units are not correct. For example: <b>IVOLT:DEL 20 μs</b> "us" can not be the unit of the impulse voltage.
Data Too Long!	Data is too long. For example: The number of characters for a file name cannot exceed 12 characters.
File Not Exist!	Load a file that is not available.
Out of file range!	File number for internal memory must be between 1 and 60.
Trigger ignores!	When SME1203-1 is in the testing state, all trigger signals will be ignored.
Command ignores!	Some command may be ignored. For example: <b>DISP:PAGE MSET</b> When SME1203-1 is in the testing state, this command will be ignored.

## Chapter 9 Technical Specifications

<b>Impulse Voltage</b>	: 300 V to 3000 V
<b>Step</b>	: 50 V steps
<b>Accuracy</b>	: 5% ± 15 V
<b>Inductance Test Range</b>	: More than 10 µH
<b>Impulse Energy</b>	: Max 90 mili-Joules
<b>Sample Rate</b>	: 40/128 MSPS, 40/64 MSPS, 40/32 MSPS, 40/16 MSPS, 40/08 MSPS, 40/04 MSPS, 40/02 MSPS, 40/01 MSPS
<b>Sample Resolution</b>	: 8bits
<b>Sampled Points</b>	: 960 points
<b>Out Impedance</b>	: 10 MΩ
<b>Test Speed</b>	: 5.5 times/sec(waveform display is off, comparator is on) 3.3 times/sec(waveform display is on, comparator is on)
<b>Averaging Rate</b>	: 1 to 30 averaging rate programmable
<b>Measurement Function</b>	: Voltage, Time and Frequency
<b>Trigger Mode</b>	: Internal, Manual, External and Bus
<b>Comparison Method</b>	: Area Size Comparison, Differential Area Comparison, Corona Discharge Comparison, Differential Phase Comparison
<b>Area Size Measurement Accuracy</b>	: ±1%
<b>Area Difference Measurement Accuracy</b>	: ±1%
<b>Comparison Output</b>	: PASS/FAIL display, Beeper alarm
<b>Beep Mode</b>	: Long High, Long Low, Single Short, Double Short tone and OFF
<b>Memory</b>	: Built-in non-volatile memory: 60 file from 1 to 60 USB Disk memory: 500 file from 61 to 560 (optional)
<b>General Information</b>	:
<b>LCD Display Resolution</b>	: 320 x 240 dot-matrix LCD
<b>Waveform Display Area</b>	: 240×200 dot-matrix
<b>Supply</b>	: 220V ± 10%, 50Hz (100/120/220/240 V available on request)
<b>Operating Condition</b>	: 0 - 40 °C, 95 % RH
<b>Dimensions</b>	: W 196, H 80, D 262 mm
<b>Weight</b>	: 3.5 kgs. Approx.
<b>Accessories</b>	:
<b>Standard Accessories</b>	: Manual:1 no., HANDLER, RS232C
<b>Optional Accessories</b>	: IEEE488, SCANNER

(Subject to change)

# Chapter 10 Warranty and Dispatch Procedure

## 10.1 Maintenance

There are no user serviceable part inside **SME1203-1**. Your **SME1203-1** Impulse Winding Tester is thoughtfully engineered for ease of use, accuracy and reliability. The instrument is carefully tested and calibrated using standards traceable to National Laboratories.

Take care of your instrument by cleaning the exterior of the instrument regularly with a dusting brush. Dirt which is difficult to remove on the casing & plastic parts, can be removed with a moist cloth ( 99% water, 1% mild detergent) spirit or washing benzene (petroleum ether) can be used to remove greasy dirt. The display may be cleaned with water or washing benzene (but not with spirit-alcohol solvents), it must then be wiped with a dry clean lint-free cloth. Under no circumstances the cleaning fluid should get into the instrument. The use of cleaning agents can attack the plastic & paint surfaces.

### 10.1.1 Power Line Fuse Replacement

The power line fuse is located on rear panel on lower right side. In case, the instrument does not show any sign of working, no LCD is lit or there is no display immediately switch OFF the mains power switch of the instrument and unplug the mains cord from the mains socket. With the help of small flat blade screwdriver remove the fuse cap of the fuse holder, located just below the socket. There is one spare fuse kept in the fuse cap, replace it for the defective one. Turn the cap so that it locks in place . The rating of the fuse is F1 A . Do not use a fuse with a higher value other wise it may damage the instrument in case, the mains voltage goes much higher than the rating of the mains fluctuation of  $\pm 10\%$ .

## **10.2 Dispatch Procedure For Service**

No user serviceable parts are inside the instrument , should it become necessary to send back the instrument to factory for service, please observe the following procedure.

Before dispatching the instrument please write to us giving full details of the fault noticed.

1. After receipt of your communication, our service department. will advise you whether it is necessary to send the instrument back to us for repairs or the adjustment is possible in your premises.
2. Dispatch the instrument (only on the receipt of our advise) securely packed in original packing duly insured and freight paid along with accessories and a copy of the faults details noticed at our Service Center listed on last page of this manual, nearest to you.

### **10.3 Warranty Conditions**

1. Scientific warrants all its Instruments to be free from defects in material and workmanship when used under normal operating conditions in accordance with the instructions given in the manual for a period of 12 (Twelve) months from date of purchase from Scientific or its authorised dealers. The service during the warranty period will be rendered on return to factory /service center basis.
2. Its obligation under this warranty is limited to repairing or replacing at its own discretion. This warranty shall not apply to any defect, failure or damage caused by accident, negligence, mis-application, alteration or attempt to repair, service or modify in any way.
3. This warranty does not include LCD, fuses, batteries or accessories. This warranty is only valid with the original purchaser who must have properly registered the product within 15 days from date of purchase. No other warranty is expressed or implied.
4. When it becomes necessary to return the instrument to our Factory facility, kindly pack it carefully in the original carton or equivalent and ship it duly insured, transportation charges prepaid.
5. Your Scientific instrument is a complex electronic device and deserves the best service available by technicians thoroughly familiar with its service and calibration procedures.