

**Programmable Switch Mode Power  
Supplies  
DCX Series 800 Watts**

**User Manual**

**scientific**

---

Copyright © Scientific All rights reserved.

## Disclaimer

This instrument contains proprietary information, no part of this manual may be photocopied, reproduced or translated without any prior written consent.

Information in this manual supercede all corresponding previous released material.

Scientific continues to improve products and reserves rights to amend part or all of the specifications, procedures, equipment at any time without notice. Scientific shall not be liable errors contained in this document or if for incidental or consequential damages in connection with the furnishing, performance or use of this material.

Rev 1.08/ 0921

Scientific Mes-Technik Pvt. Ltd.,  
B-14 Industrial Estate, Pologround,  
Indore- 452015,  
India  
Tel : 0731-2422330/31/32/33  
Fax : 0731-2422334,561641  
Email : [info@scientificindia.com](mailto:info@scientificindia.com)  
Website: [www.scientificindia.com](http://www.scientificindia.com)



# Programmable Switch Mode Power Supplies DCX Series 800 Watts

## Table of Contents

<b>Introduction</b> .....	5
<b>Safety instructions</b> .....	6
<b>Safety symbols</b> .....	7
<b>Chapter 1 Technical specifications</b> .....	8
1.1 Specifications.....	8
1.2 Power supply outline drawings - dimension.....	11
<b>Chapter 2 Panel controls</b> .....	13
2.1 Front panel controls.....	13
2.2 Rear panel controls.....	15
2.3 Sockets, connector description used on rear panel.....	16
2.4 Connection diagram for interface cables.....	18
2.4.1 USB cable.....	18
2.4.2 RS232/RS485 cable.....	18
2.4.3 Analog programming cable.....	18
2.4.4 Master-Slave cable.....	18
2.4.5 LAN cable.....	18
<b>Chapter 3 Installation</b> .....	19
3.1 AC Input mains connections.....	19
3.2 Cooling.....	19
3.3 Use of instrument on table top.....	19
3.4 Use of instrument in 19" Rack mounting cabinet.....	20
3.5 High Voltage Protection Cover for Safety.....	21
3.6 First time operation power ON.....	22
3.6.1 AC mains input.....	22
3.6.2 Connecting to AC mains.....	22
3.6.3 DC output check.....	23
3.6.4 DC constant current check.....	23
<b>Chapter 4 Descriptions</b> .....	24
4.1 Safety first - grounding.....	24
4.2 Input Voltage.....	24
4.3 Operating conditions.....	24
4.3.1 Temperature & humidity.....	24
4.3.2 Storage.....	24
4.4 Thermal protection.....	24
4.5 Cooling.....	25
4.6 Output.....	25
4.7 Connecting the load.....	26
4.8 Local & remote Sensing.....	27
4.9 Constant voltage and constant current mode.....	27
4.10 Hold up time.....	28
4.11 Over voltage protection.....	28
4.12 Under Voltage limit.....	28
4.13 Fold back protection.....	28
4.14 AC fail.....	28

4.15	Analog programming .....	29
4.16	Description of analog connector pins and application .....	30
4.17	Safe start - auto start mode .....	33
4.18	Last save memory .....	33
4.19	Front panel locking .....	34
4.20	Remote control mode in RS232, RS485 and USB .....	34
4.21	Connecting load .....	34
4.22	Connecting power supplies in series and parallel .....	34
4.23	Power supply as battery charger .....	35
4.24	Local Area Network (LAN) .....	35
<b>Chapter 5 Menu controls .....</b>		<b>36</b>
5.1	Power ON switching .....	36
5.2	Voltage & Current setting .....	36
5.3	Over Voltage setting .....	37
5.4	Under Voltage setting .....	37
5.5	Fold back protection .....	38
5.6	Output On/Off .....	38
5.7	Communication set Menu .....	38
5.8	Master/Save Menu .....	41
5.9	Front panel lock .....	41
<b>Chapter 6 Communication Interface Protocol .....</b>		<b>42</b>
6.1	SCPI commands .....	42
6.1.1	Remote mode enable .....	42
6.1.2	Remote mode disable .....	42
6.1.3	Read instrument identity .....	42
6.1.4	Set output voltage .....	42
6.1.5	Set output current .....	43
6.1.6	Set Under Voltage limit .....	43
6.1.7	Set Over Voltage Protection .....	43
6.1.8	Set Output ON/OFF .....	43
6.1.9	Read set voltage .....	43
6.1.10	Read set current .....	44
6.1.11	Read Under Voltage limit .....	44
6.1.12	Read Over Voltage Protection set .....	44
6.1.13	Read measured output voltage .....	44
6.1.14	Read measured output current .....	44
6.1.15	Fold back enable/disable .....	44
6.1.16	Read measured output power .....	45
6.1.17	Read measured internal temperature .....	45
6.1.18	Status .....	45
6.1.19	Read LAN configuration .....	45
<b>Chapter 7 Maintenance .....</b>		<b>46</b>
7.1	Troubleshooting .....	46
<b>Chapter 8 Dispatch procedure for service &amp; Warranty .....</b>		<b>48</b>
8.1	Dispatch procedure for service .....	48
8.2	Warranty .....	48

## **Programmable Switch Mode Power Supplies DCX Series 800 Watts**

- Compact 1 U size
- Multi range Output
- Fast transient response
- High slew Rate
- Interface RS232, RS485, USB  
LAN (optional)
- Universal Mains

The DCX power supplies is designed for compact 1 U size with user friendly operation and higher efficiency. This range offer multi ranging output characteristic which makes them more flexible than traditional or rectangular output characteristic power supplies as they give multiple voltage and current combination in a single power supply.

This series of power supplies offer fast up programming time allowing creation of multiple complex waveforms. Transient response better than 100 us, ensures that the output of the power supply recovers much faster and remains constant and oscillation free for dynamic loads.

Power supplies can be remotely controlled programmed through any of interface analog programming , USB, RS232 or RS485, optional LAN. Power supplies can be programmed from 0 to full scale voltage and current. SCPI compatible commands offer flexibility in programming in system integration. Power capabilities can be added by connecting four power supply units in parallel or in series up to 600V.

With various protection features, over voltage protection, short circuit protection, fold back etc. protects expensive loads circuits in testing. Fold back protection allows to set precise maximum current to be allowed, which when exceed output gets disabled. User selectable last save memory, allows user to quickly start the testing from previous test conditions.

All the DCX models have universal mains input range for worldwide operation. They can be operated from line voltage 90 V ~ 270 V , 47 Hz ~ 63 Hz. Power factor correction also provides to ensure low harmonic content.

## Safety instructions

The general safety instructions and symbols must be observed during all phases of operation of this instrument. Failure to comply with these precautions or with specific warnings or instructions given in this manual violates safety standards of design, manufacture, and intended use of the instrument. Scientific assumes no liability for the customer's failure to comply with these requirements.

- Before applying power, verify all the safety precautions are taken, make all the connections firm.
- Make sure the protective ground of the unit is connected with system ground.
- Always operate the instrument only in prescribed operating conditions.
- Do not modify the instrument, This instrument is designed to meet all the safety and operating conditions. Any modification done may not be complying to the safety requirement and instrument may be damaged , causing hazardous conditions.

## Environmental conditions

Please do not operate the instrument in the place that vibrates, dusty, under direct sunlight or where there is corrosive air. The Scientific Power supplies are designed for safety, applies to following conditions.

- Indoor use.
- Ambient temperature 0 ~ 50°C non condensing 75% RH , 0~40°C non condensing 95% RH
- Altitude up to 3000 meters
- Pollution degree 2

## Installation category

These instruments are designed for installation category II, Over voltage category II.

## Grounding

The instrument ground must be well connected to instrument chassis of AC power mains input supply. The instrument must be connected through three conductor power cable, with the ground wire firmly connected to the electrical safety ground of power outlet. Any interruption in protective ground conductor , or disconnection will cause potential hazard that might cause personal injury.

## Mains Input rating

This power supply unit is designed for specific mains input connections, as specified in the Technical specifications. Do not use AC supply exceeding the limits. For safety reasons the mains AC may should not fluctuate more than  $\pm 10\%$  of nominal voltage.

## Fuse

Fuses must be changed by authorized Scientific service personal only for continued protection against risk and safety.

## Live circuits

There are no serviceable part or alignment required by Operating personnel. Operating must not remove the instrument cover. No internal adjustment or component replacement is allowed by non-Scientific authorised qualified personnel. Never replace components with power cable connected. To avoid injuries, always disconnect power, discharge circuits and remove external voltage source before touching components.

## Safety symbols

### Caution!

Caution ! : Denotes a hazard. Failure to follow instructions could result in minor personal injury and/or property damage. Follow the instructions for proper procedures.

### Warning!

Warning ! : Denotes a hazard. Failure to follow instructions could result in **SEVERE** personal injury and/or property damage. Follow the instructions for proper procedures.

## Symbols marked on instruments



Attention refer to the manual.



Hazardous voltage exists, **Caution!** Electric shock.



Indicates Protective Ground Terminal



Indicates Ground Terminal



Off ( Supply )



On ( Supply )

## Information on electrical and electronic equipment recycling



Our Equipment contain high quality components and material and are designated to facilitate recycling. After appropriate use of this equipment , when this is to be discarded , the equipment must not be treated as municipal waste. This must be disposed of separately via the appropriate return and collection system available. By following these instructions, you ensure that the product is treated correctly and help to reduce potential impacts on the environment and human health, which otherwise result from inappropriate handling. Recycling helps to conserve natural resources and protect environment.

For more information on collection and return, please contact dealer / from where you have purchased / to us giving full details.

## Chapter 1 Technical specifications

Unless otherwise stated these specifications are defined over the temperature range of 0 to 40° C .

### 1.1 Specifications

	DCX20M80	DCX60M26	DCX160M10	DCX600M2.67	DCX1000M1.6
DC Outputs Voltage	20V	60V	160V	600V	1000V
	Multi Ranging *				
DC Output Current	80A	26.5A	10A	2.67A	1.6
Power	800 Watts				
Efficiency at 230V full load	80%	87%	87%	88%	86%
Constant Voltage Mode					
Load regulation 0 ~ 100% (mV)	1	2	5	20	40
Line Regulation (mV)	1	1	2	2	10
Ripple (mVrms) BW=300 kHz	5	5	8	20	90
Ripple (mVrms) 5Hz~1MHz	15	5	8	30	100
Ripple (mVpp) 20 MHz	20	20	30	50	200
Constant Current Mode					
Load regulation 0 ~ 100 % (mA)	25	7	3	10	10
Line Regulation (mA)	2	3.5	2	5	2
Ripple (mArms) BW=5 Hz ~1MHz	25	10	5	5	5
Ripple (mApp) 20 MHz	100	25	15	20	20
Remote sense drop	1 V typically	2 V typically		5 V typically	
Programming Speed					
Rise time ( 10% to 90% ) into resistive load					
Time 100% load	10V : 6.5ms 20V : 12ms	30V : 6ms 60V : 25ms	80V : 30ms 160V : 80ms	300V : 70ms 600V : 225ms	500V : 45ms 1000V : 180ms
Time 10% load	10V : 2.5ms 20V : 5ms	30V : 2.5ms 60V : 10ms	80V : 20ms 160V : 50ms	300V : 20ms 600V : 100ms	500V : 40ms 1000V : 160ms
Fall time ( 90% to 10% ) into resistive load					
Time 100% load	10V : 6.5ms 20V : 12ms	30V : 6ms 60V : 25ms	80V : 30ms 160V : 100s	300V : 60ms 600V : 200ms	500V : 50ms 1000V : 190ms
Time 10% load	10V : 60ms 20V : 120ms	30V : 60ms 60V : 250ms	80V : 250ms 160V : 900ms	300V : 600ms 600V : 2s	500V : 500ms 1000V : 1.8s
Time No load	10V : 0.5s 20V : 1s	30V : 1s 60V : 2.5s	80V : 3s 160V : 5s	300V : 6s 600V : 10s	500V : 10s 1000V : 15s
Recovery Time					
Recovery within	80mV	80mV	100mV	0.5V	1V
time @ 50 – 100 % load step	100us	100us	100us	100us	100us
max deviation @ 230 V mains	10V : 300mV 20V : 160mV	30V : 300mV 60V : 150mV	80V : 1V 160V : 500mV	300V : 1V 600V : 1.5V	500V : 1.5V 1000V : 3V
Output Impedance	CV, 0-1kHz CV, 1-100kHz	< 10 mΩ < 30 mΩ	< 10 mΩ < 30 mΩ	< 20 mΩ < 30 mΩ	< 400 mΩ < 3Ω



	DCX20M80	DCX60M26	DCX160M10	DCX600M2.67	DCX1000M1.6	
Temperature Coefficients	CV : 50 ppm/°C CC : 60 ppm after warm up of 30 min and during 8 hrs					
Output Stability	CV : 80 ppm/°C CC : 100 ppm after warm up of 30 min and during 8 hrs					
Analog Programing (Rear panel 25 pin D connector)						
Programing	V : 0 ~ 5 V/10V, Accuracy : $\pm 0.5$ % of Vout rated, Input impedance : 1 M $\Omega$ I : 0 ~ 5 V, Accuracy : $\pm 1$ % of Iout rated Input impedance : 1 M $\Omega$					
Monitoring	V out : 0 ~ 5 V/10V, Accuracy : $\pm 1$ % of Vout rated output impedance : 150 $\Omega$ / 4 mA max I out : 0 ~ 5 V, Accuracy : $\pm 1$ % of Iout rated Output impedance : 150 $\Omega$ / 4 mA max					
V reference	5.1 V $\pm$ 15 mV					
Resistor Programing	Voltage : 0~100%, 0~5/10 k $\Omega$ full scale, user selectable Accuracy and linearity : $\pm 1$ % of Vout rated Current : 0~100%, 0~5/10 k $\Omega$ full scale, user selectable Accuracy and linearity : $\pm 1.5$ % of Iout rated					
Status outputs	Power Supply OK Logic 1 (High); AC Fail – Logic 0 (Low) DC Fail – Logic 0 (Low), for DC fails by $\pm 5$ % set value CV / CC Status : CV :Logic 0 / CC Logic 1 Interlock : Dry contact , Short = Power Supply enabled , Open = Power Supply disabled DC ON status – ON = Logic 1 , OFF = Logic 0 OVP status Fault : Logic 0, else OK =Logic 1 OTP status Fault : Logic 0, else OK =Logic 1 Remote status : Remote= Logic 1 , Local = Logic 0					
Remote shutdown	+5 V					
Remote Programing						
RS232 / USB / RS485 LAN(optional) Voltage Programing Current Programing Monitor Voltage Monitor Current OVL & UVL	ADC : 16 Bits , DAC : 16 Bits Resolution : better than 15 Bits Accuracy : 0.05% Vout + 0.05% Vrated Resolution : Better than 15 bits Accuracy : 0.1% Iout + 0.1% I rated Resolution : Better than 15 bits Accuracy : 0.1% Vout + 0.1% V rated Resolution : Better than 15 bits Accuracy : 0.25% Iout + 0.02% I rated Resolution : better than 15 Bits Accuracy : 0.05% Vout + 0.05% Vrated					
Front Panel controls Indicators :	Mains ON/ OFF, Voltage and Current setting with Encoder, switch settings : Set, Over voltage, Under Voltage , Fold back, Remote & Output LEDs for CV, CC, Over Voltage, Under Voltage, Fold back, Remote and Output ON					
Display						
Resolution	Voltage	4 digit	4 digit	4 digit	4 digit	4 digit
	Current	4 digit	4 digit	4 digit	3 digit	3 digit
Accuracy	$\pm (0.5 \% + 2 d)$					
Display scale	Voltage	0 ~ 20.00 V	0 ~ 60.00 V	0 ~ 160.0 V	0 ~ 600.0 V	0 ~ 1000V
	Current	0 ~ 80.00 A	0 ~ 26.50 A	0 ~ 10.00 A	0 ~ 2.67 A	0 ~ 1.6
Protections	Over voltage , Over current, Short Circuit, Fold Back, Over temperature					
Output Terminals	Bus bar with M5 bolts					
Parallel operation	Up to 4 units					

	DCX20M80	DCX60M26	DCX160M10	DCX600M2.67	DCX1000M1.6
Serial operation	max 600 V to chassis			max 1200 V to chassis	No series operation
Mains Input	Universal AC input, Single phase, 90 ~ 270V, 50 / 60 Hz ( 47 ~ 63Hz) Input connector : IEC320/C14 , EN 60320/14 Standby Power : 30 Watts @ 230V (Vout max, No load) Internal Fuse L : 15 A, 6.3 x 32 mm ceramic fuse.				
Power Factor	0.99 @ full load / 0.98 @ 50% load				
Turn On delay	600 ms after mains switched ON				
Inrush current	<25A				
Hold up Time	20 ms				
Environment Conditions					
Operating Temperature	-20 ~ +50°C; with 100% load; derated 75% at 60°C				
Storage	-40 ~ + 85°C				
Humidity	max. 95% non condensing at 40°C, max. 75% non condensing at 50°C				
Safety	Insulation : Input to Output : 3750 V for 1 min Input to case : 2500 Vrms Output to case : 600 V Insulation resistance : 100 MΩ at 25°C, 70% RH, 500 Vdc				
Dimension	W x D x H : 443 x 475 x 43.5 mm (1U, 19" Rack size) excluding connectors, terminals, switches, front and back panel controls, handles etc.				
Weight	8.9 kg approx.				
Cooling	Forced , variable Fan speed				
Accessories	Mains Cord, USB Cable, RS232/485 Cable, CD				

#### Notes:

1. Subject to change without notice.
2. Sensing at the rear panel of the power supply unit at sense terminals.
3. Unit warm up time is 30 min.
4. Minimum output voltage guaranteed to maximum of 0.2% rated.
5. Minimum output current guaranteed to maximum of 0.4% rated.

#### \* Multi range output

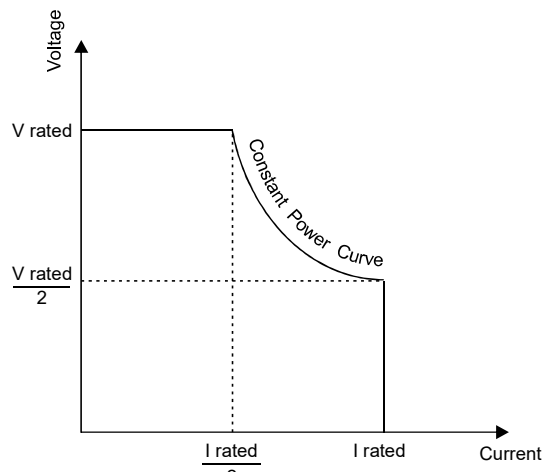

## 1.2 Power supply outline drawings - dimension

Front panel when unit is used on table top :

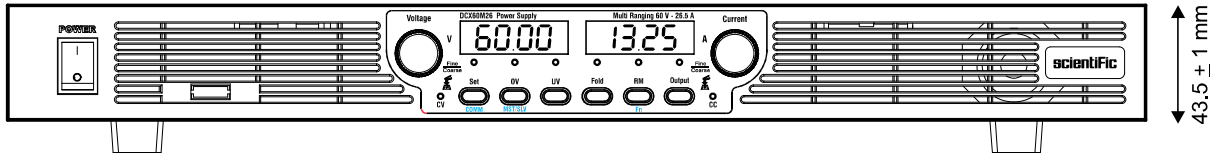

Note : Height excluding instrument feet

432.0 ± 1 mm

Front panel when unit is mounted in 19" rack cabinet :

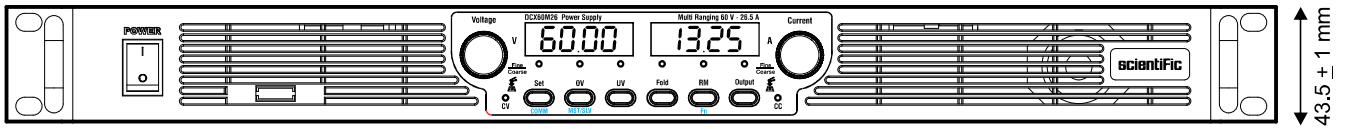

Note : When the power supply unit is mounted in 19" rack cabinet, instrument feet are removed and side rack mounting handle assemblies are fitted on both side.

482.5 ± 1 mm

Rear panel when unit is used on table top :

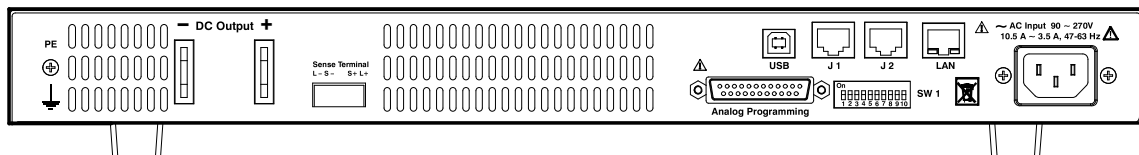

432.0 ± 1 mm

Side view when unit is used on table top :

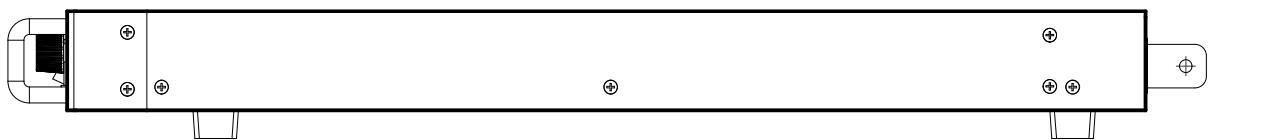

25.0 mm

27.0 mm

475 ± 1 mm

Top view :

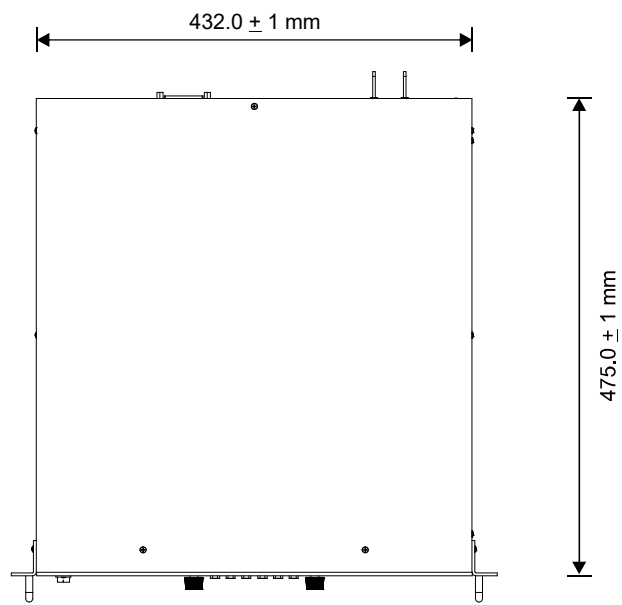

Output bus dimension :

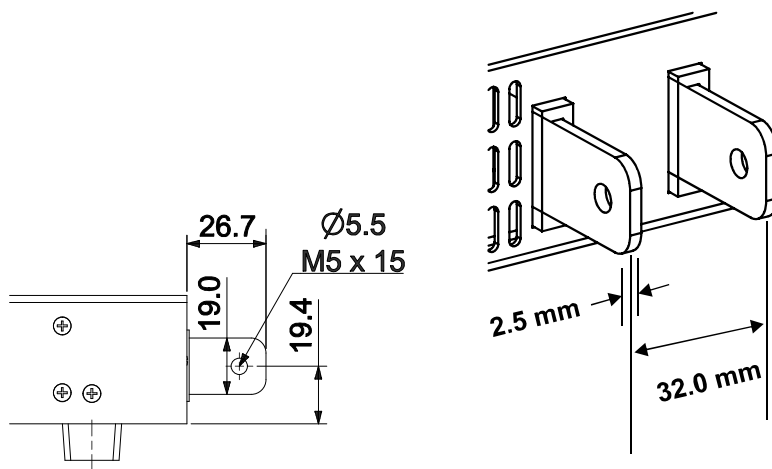

## Chapter 2 Panel controls

### 2.1 Front panel controls

The front panel controls are arranged ergonomically to ease in operation with indicators. Before using the power supply unit, please read the following explanation to each control and connectors.

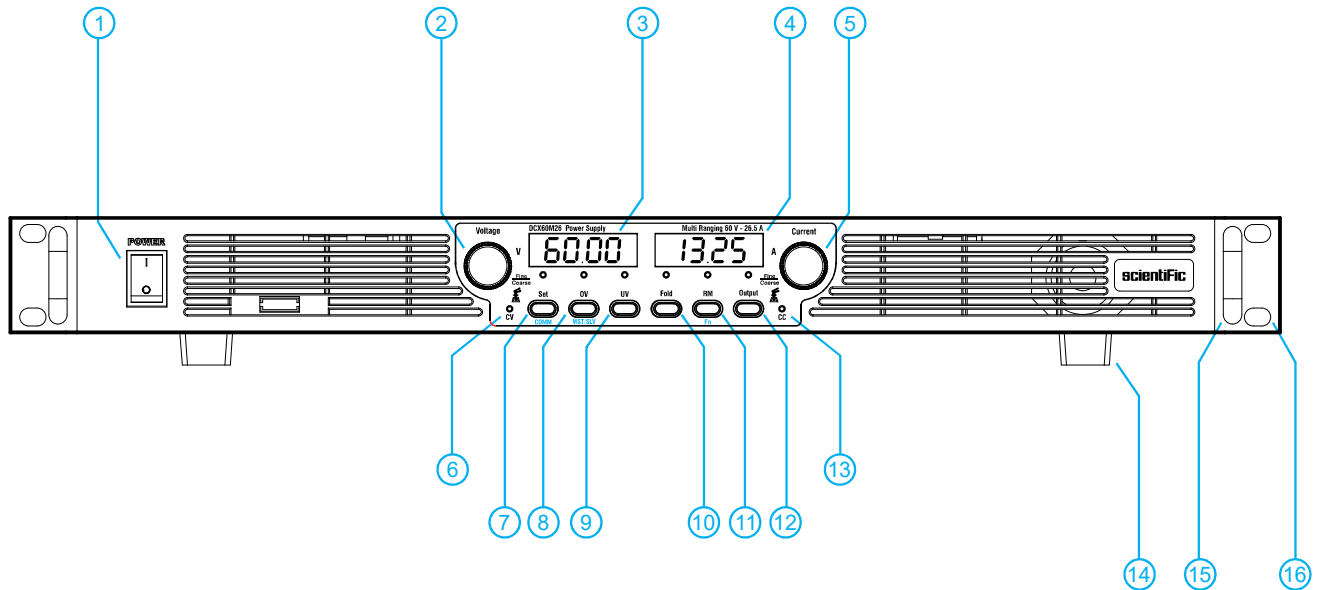

- ① AC Power Switch : Mains AC power ON/Off control, when switched to ON, supplies main AC power to unit.
- ② Voltage control : Voltage control encoder for setting the voltage. When pressed, it gives fine adjustment control. It is also used for setting the over voltage, under voltage level settings. When used with Menu, it is used for setting the parameters in Menu selection.
- ③ Display Voltage : 4 digit display for setting and measured of output voltage. When used in combination with OV or UV, it displays over voltage and under voltage setting. When used with Menu it displays parameters.
- ④ Display Current : 4 digit display for setting and measured of output current. When used with Menu it displays parameters.
- ⑤ Current control : Current control encoder for setting the current limits. When pressed, it gives fine adjustment control. When used with Menu, it is used for setting the parameters in Menu selection.
- ⑥ CV LED indicator : LED indicator for CV, lights when power supply is in constant voltage mode.
- ⑦ Set & Comm : Push button control for selecting setting for voltage or current. When pressed in combination with “Fn” button, “Comm” mode selected. Comm mode used for communication parameters. Associated LED above the button, lights when voltage and current settings selected.

- ⑧ OV & MST/SLV : Push button control for selecting setting for over voltage. When pressed in combination with “Fn” button, “MST/SLV” mode selected. MST/SLV mode is reserved for future development and release.
- ⑨ UV : Push button control for selecting setting for under voltage. Associated LED above the button, lights when under voltage setting is selected .
- ⑩ Fold : Push button control for enabling / disabling Fold mode. Associated LED above the button, lights when fold back protection enabled.
- ⑪ RM & Fn : Push button control for releasing instrument from Remote control. Associated LED above lights when instrument is in remote control mode. When pressed in local mode it acts as a “Fn” button.
- ⑫ Output : Push button to control DC output ON / Off. Associated LED above lights when the output is ON.
- ⑬ CC LED : LED indicator for CC , lights when power supply is in constant current mode.
- ⑭ Instrument Feet : Instrument feet, to be fixed when power supply unit is to be used on table. Else not needed when mounted in 19” rack cabinet.
- ⑮ Instrument handel : Mounted on either side of the power supply unit for lifting the unit while mounting in 19” rack cabinet.
- ⑯ Mounting holes : Mounting holes used in fixing the unit in 19” rack cabinet.

## 2.2 Rear panel controls

The rear panel is arranged with mains inlet connector, output terminals and communication ports etc. .

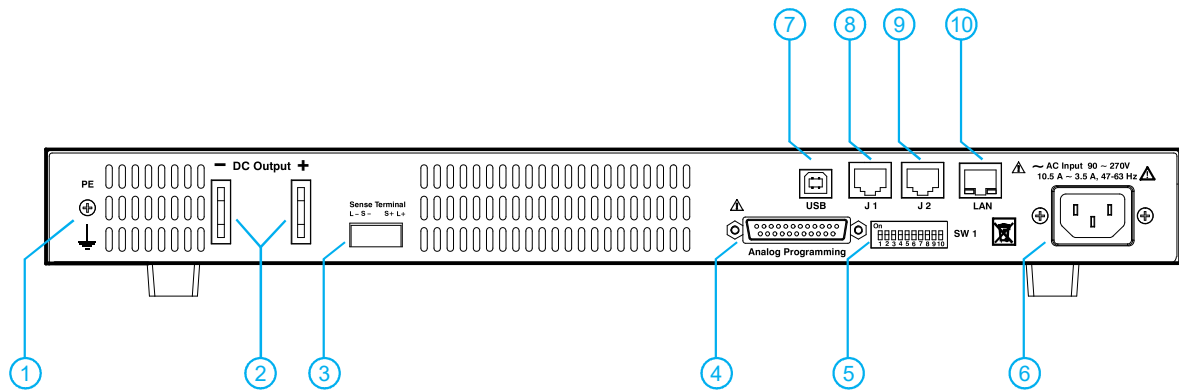

- ① PE : Terminal provided to make connection of protective earth.
- ② – DC Output + : DC Output Bus bars , to connect the load.
- ③ Sense Terminals : Remote sense terminals. Mating connector is provided with the instrument.
- ④ Analog Programming: 25 pin (F) D type connector for remote analog programming. Refer page 17 & 27 for details.
- ⑤ SW 1 : 8 Position DIP Set up switch , for settings various functions.
- ⑥ AC Input : AC mains inlet socket to power the instrument.
- ⑦ USB : USB “B” connector , to connect the power supply to computer for remote control operations.
- ⑧ & ⑨ J1- J2 : RJ45 connector , gives connections for RS232 , RS485
- ⑩ LAN : LAN ( RJ45) connector for connecting PC for remote operations (optional).

### 2.3 Sockets, connector description used on rear panel

The rear panel has different types of connections to other equipments for controlling, monitoring etc. , followings are connections for quick understanding. Detailed description on each is in specific inside the manual.

#### Sense Terminal

Pin 1	L -	Local sense -
Pin 2	S -	Remote sense -
Pin 3	NC	Not connected
Pin 4	S +	Remote sense +
Pin 5	L +	Local sense +

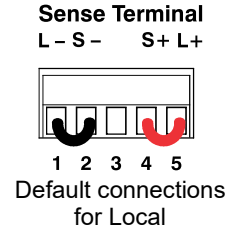
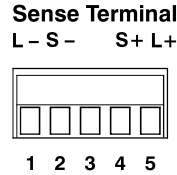

#### SW 1 : 10 Pin DIP Set up switch

	DIP Switch Position	Up ↑	Down ↓
Pin 1	Reserved (keep it Down)		Down
Pin 2	Interlock	Enable	Disable
Pin 3	Output ON on mains switched ON	Last saved	Output OFF
Pin 4	Programming Voltage / Resistance	Resistance	Voltage
Pin 5	Current Monitor output	10 V	5 V
Pin 6	Voltage Monitor output	10 V	5 V
Pin 7	Current Programming Front Panel / Analog connector	Analog Programming	Front Panel
Pin 8	Current / Resistance 5 / 10 Programming	10 V/kΩ	5 V/kΩ
Pin 9	Voltage Programming Front Panel / Analog connector	Analog Programming	Front Panel
Pin 10	Voltage / Resistance 5 / 10 Programming	10 V/kΩ	5 V/kΩ

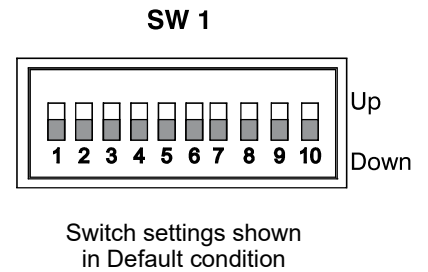

#### Connector J1 ( RJ45 ) RS232 / Rs485

Pin 1	Return ground
Pin 2	Not used, reserved for future, do not connect anywhere
Pin 3	RS485 Rx +
Pin 4	RS485 Tx +
Pin 5	RS485 Tx -
Pin 6	RS485 Rx -
Pin 7	RS232 Tx
Pin 8	RS232 Rx

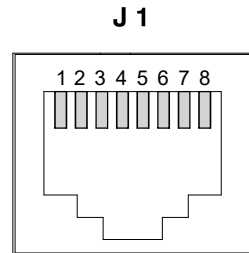

#### Connector J2 ( RJ45 ) Master - Slave

Pin 1	Return ground
Pin 2	Slave Connect
Pin 3	Tx +
Pin 4	Rx +
Pin 5	Rx -
Pin 6	Tx -
Pin 7	Not Connected
Pin 8	Not Connected

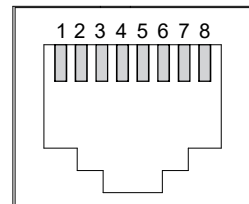



## Analog programming connector

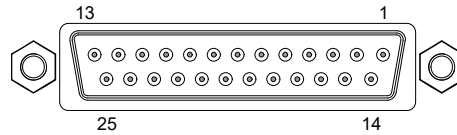

Pin 1	Interlock +
Pin 2	Ground Analog Programming
Pin 3	Ground Analog Programming
Pin 4	Reserved, Please do not connected any circuit to this pin !
Pin 5	Over Voltage Status
Pin 6	Over Temperature Status
Pin 7	Reference Voltage output 5.1 V
Pin 8	Not Connected
Pin 9	Voltage Programming input
Pin 10	Current Programming input
Pin 11	Voltage Monitoring Output
Pin 12	Ground Analog Programming
Pin 13	CV / CC Status
Pin 14	Interlock –
Pin 15	Remote Shut Down input
Pin 16	Power Supply status
Pin 17	DC Output ON status
Pin 18	Reserved, Please do not connected any circuit to this pin !
Pin 19	AC Fail status output
Pin 20	DC Fail status output
Pin 21	Remote Control status output
Pin 22	Ground Analog Programming
Pin 23	Ground Analog Programming
Pin 24	Current Monitoring Output
Pin 25	Not connected

### LAN Socket (RJ45)

LAN / Ethernet Socket is standard RJ45 socket.

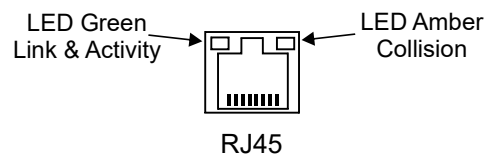

### USB Socket

USB socket is standard USB socket type B.

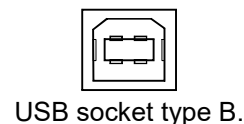

## 2.4 Connection diagram for interface cables used

To connect the power supply unit for remote control, the connecting cable wiring diagram is given below.

### 2.4.1 USB Cable

This is a standard USB cable connector type A to type B, used for connecting power supply to host ( computer or others). This is supplied as standard accessories with the unit.

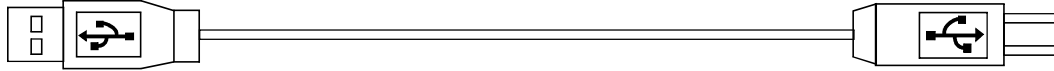

### 2.4.2 RS232/RS485 Cable

This cable is end User specific depends on the connections to remote units, panels etc. One end of this cable is RJ45 (male) and other end is DB 9 ( Female) connector. User can assemble it as per their required length, not more than 9 meter. Also available as optional accessories from Scientific.

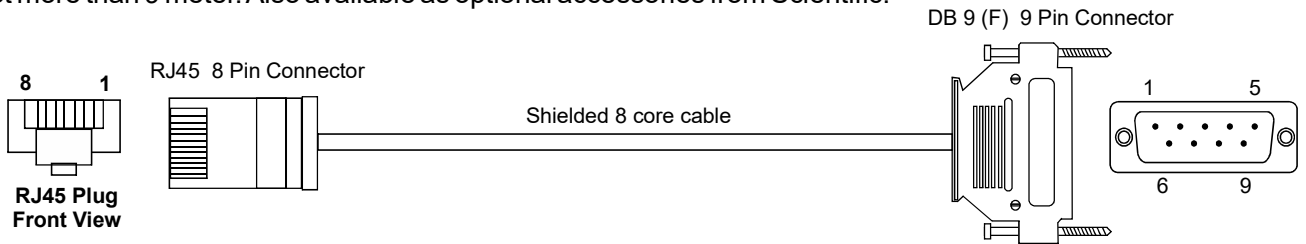

8 Pin RJ45 Connector		UTP Flat or shielded 8 core cable	DB 9 (F) Connector	
Pin No.	Signal		Pin No.	Signal
1	Signal ground		5	Signal ground
2	Not connected		1	Not Connected
3	RXD +		4	RXD +
4	TXD +		6	TXD +
5	TXD –		7	TXD –
6	RXD –		8	RXD –
7	Rx		3	Tx
8	Tx		2	Rx

### 2.4.3 Analog programming cable

This cable is end User specific depends on the connections to remote units, panels etc. To prepare cable, you will need standard DB 25 (male) connector, which connects the power supply rear panel at Analog programming connector, DB 25 (Female) connector. Depending on the required connection any good quality multi core shielded cable can be use. For pin details please refer Analog programming in chapter 4 for connections.

### 2.4.4 Master - Slave cable

For connecting power supplies in Master-Slave , use short length standard RJ45 to RJ45 ( 1:1 wired) cable.

### 2.4.5 LAN Cable

For connecting power supply to computers, use standard 1:1 LAN/Ethernet cable.

## Chapter 3 Installation

Your instrument is thoughtfully designed, manufactured, tested and inspected, found free of mechanical and electrical defects. When you receive the instrument, some inspections are necessary, and the condition must be understood and available before installing the instrument. Inspect the shipping container for damage if any after unpacking it. It is not recommended to use the instrument in the case of a damaged container. Keep all packing material until the inspection has been completed. If damage is detected, file a claim with carrier immediately and inform the Dealer, sales or authorized service facility nearest // Scientific to you.

If the contents in the container do not conform to the packing list, notify us or your dealer. Before putting this instrument in operation, make sure you go through the manual, safety and Cautions guidelines.

Ensure that the environmental conditions are fulfilled. Ensure that the instrument is not be used in place with vibrations, heating or exposed to sky, direct sunlight, for proper functioning and extensive life of service.

### 3.1 AC input mains connections

The mains AC socket ( IEC compatible ) is provided on the rear panel. Use the mains cord provided with the instrument, alternative ensure appropriate rating cable is used for connections as per the standard mains cord used in your country. This power supply unit can be operated from 90 V ~ 270V, 47 ~ 63 Hz.

### 3.2 Cooling

The power supply unit is forced air cooled, it has two internal fans, the speed of the fans depends on the temperature of internal heat sinks. The air movement is from front to rear. Allow approximately 10 cms of free space on front and rear of the instrument, for free air movement. This allows stacking power supplies one above other and in 19" rack cabinets. For prolonged life of the power supply, the inlet temperature of air should be below 35°C. The instrument control circuit senses heat sink temperature, power delivered and adjust the fan speed accordingly. Thus the speed is controlled in pulsating mode, during this period, high pitch sound is produced, this is normal.

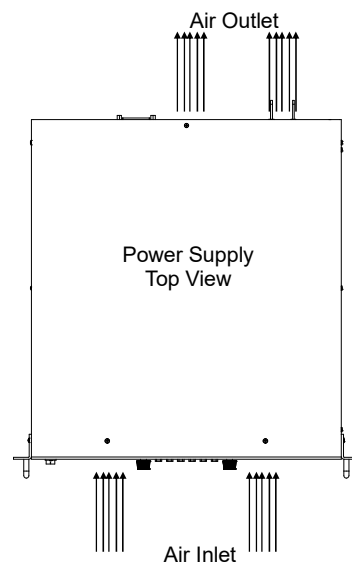

### 3.3 Use of instrument on table top

The power supply does not need any additional fitting / assembly of part. Ensure that the instrument feet are mounted on bottom side of the power supply unit. If not using appropriate screw driver, fix the instrument feet ( 4 nos. ) provided with unit.

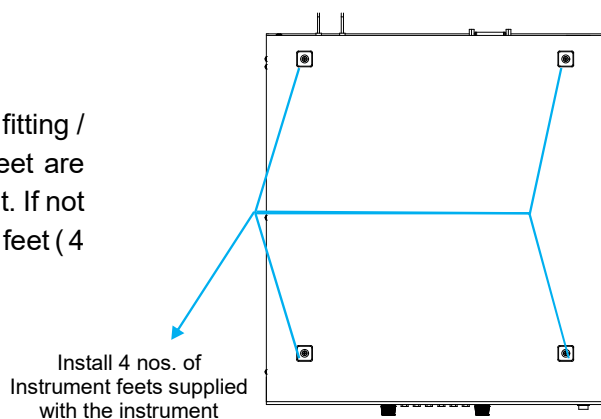

### 3.4 Use of instrument in 19" rack mounting cabinet

This power supply unit is designed to fit in standard 19" rack mount cabinet. it requires few parts to be installed before placing it in cabinet.

1. Use the front panel rack mount brackets and fix it on left and right side of the instrument as shown below. Figure below shows mounting of screws on right side, repeat the same for left side.
2. Use the rear panel support plate , if available , fix it on rear sides of the instrument, shown below. Else order the Rear Panel Support Plates optional available.

#### Caution !

Ensure that the supplied screws used for mounting only, else use appropriate screws of size M3x 6 mm. Ensure that they do not penetrate more than 6 mm inside.

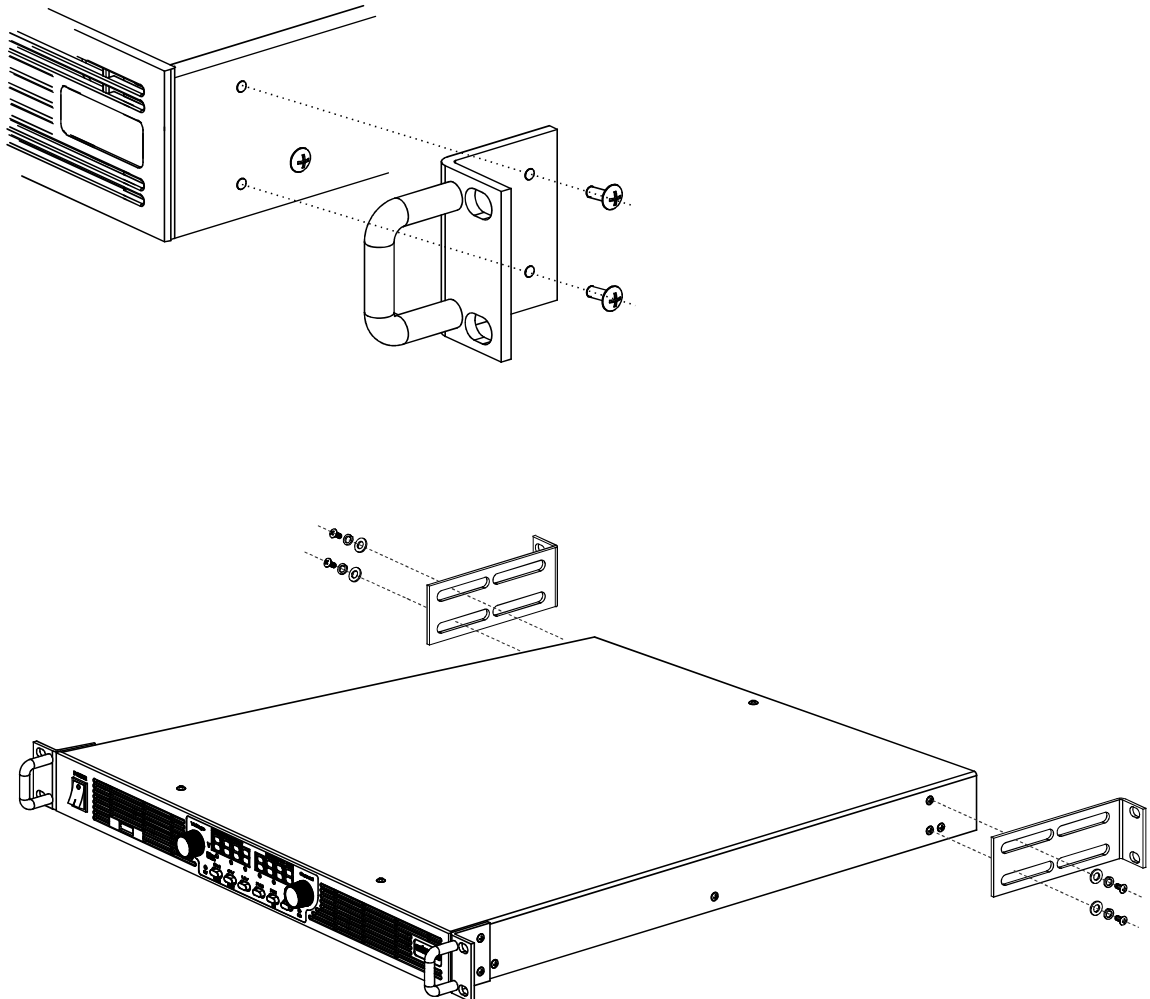

### 3.5 High Voltage Protection Cover for Safety

For safety, while using power supplies above 60V, the output terminals / Bus bars are to be protected for accidentally being touched for the safety of the operator.

A Safety protection cover is provided with power supply unit as an accessory. We highly recommend to install it to avoid any potential hazard to the operator / User / personnel.

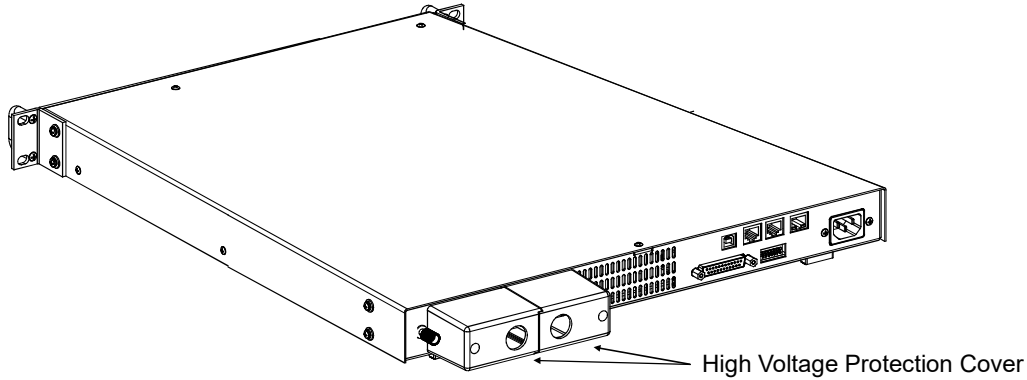

Mounting of this part is very simple. Pass the cables through the protection cover before mounting the cables on bus bar. Connect the cables on bus bar, push the protection cover to touch the rear panel and fix with the screws.

Before any making electrical connections or removing the connections, ensure the power supply bus is fully discharged. Please refer to safety instructions, before connecting / disconnecting the output connections.

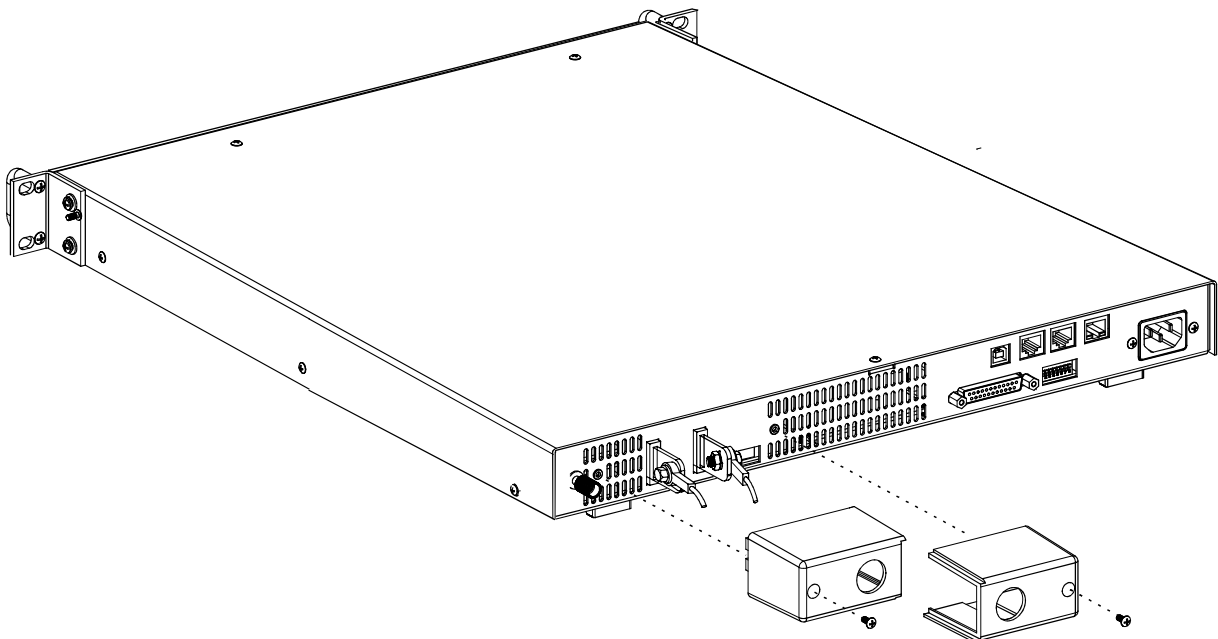

### 3.6 Firsttime operation power ON

Prior to power ON , ensure the followings,

- POWER On/Off switch on front panel is in Off position.
- There is no condensation on the unit, if any, allow some time to get it dry.
- DIP switch on the rear panel is set to down positions as shown below.

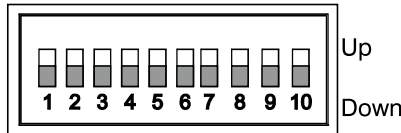

- Remote sense wires are connected as shown below, if not, make the connection as shown.

Pin 1	L -	Local sense -
Pin 2	S -	Remote sense -
Pin 3	NC	Not connected
Pin 4	S +	Remote sense +
Pin 5	L +	Local sense +

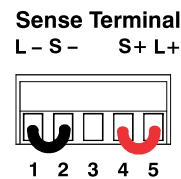

The five pin sense plug can be pulled out from the socket, place the wires and re-insert the plug in sense terminal socket.

#### 3.6.1 AC mains input

This power supply unit is designed for universal mains input. The mains input can be connected from 90V to 270 V 50 Hz / 60 Hz. While connecting to 200 to 250 V mains, mains cord of 250 V, 6 A can be used, however to connect it on lower voltages from 100V higher current rating 16A power cord to be used.

#### Caution !

1. The Power Supply Unit must be connected to mains inlet having earth connection.
2. For safety the chassis of this unit is connected to protective earth potential.
3. Do not interrupt earth connection, else chassis will be floated and unsafe. Personal touching in this case liable to get electric shock.
4. Do not touch lead-wire connected with output terminal when the output is ON. Do not touch such parts immediately after output is cutoff. Failure to do so could result in serious injuries or could be fatal.
5. When the mains cord is connected , even in power off conditions, few components in power supply unit is still connected to the AC mains. To avoid any electrical shock, first remove the mains cord, wait for two to three minutes, before opening the instrument cover.

#### 3.6.2 Connecting to AC mains

- Connect the AC mains inlet cable, after ensuring correct AC mains availability.
- Switch the POWER switch to ON position.
- The display will light and display will show “ OP OFF ”, this means the power supply is connected to AC mains and power supply is ready to use.
- Switch the POWER switch to Off position.

### 3.6.3 DC output check

- Connect the DVM/DMM in appropriate voltage range depending on power supply output voltage.
- Press the push button “Output”, the associated output LED will light, indicating the output is available on bus bar at the rear panel.
- Rotate the Voltage control encoder, the displayed voltage will vary with encoder variation.
- Observe the DMM reading and check with power supply display reading, the DMM reading should be within the stated accuracies of the output voltage.
- The minimum voltage reading is close to zero to maximum voltage as per specification of the model.
- Press the push button “Output”, the DC output will be switched off and output LED will be off.
- Switch Off the AC power switch.

### 3.6.4 DC constant current check

- Connect the DC shunt across the power supply output terminals with appropriate cables of current capacity. Ensure that the shunt and wire capacities are more than the power supply power.
- Connect the DMM in mV range across the DC shunt .
- Switch the POWER to ON position.
- Press the “Set” push button, the associated output LED will light, indicating that voltage and or current now can be set , before the output is switched ON.
- Rotate the Voltage control encoder, such that the voltage set is approx. 1.00 Volts
- Rotate the Current control encoder, such that the current set is approx. 1.00A.
- Press the “Output” push button, the associated output LED will light, indicating the output is available on bus bar at the rear panel.
- Observe the DMM reading and compare it with the current displayed reading, it should be in specified accuracy.
- The minimum to maximum constant current can be checked with connecting the appropriate DC shunts.
- Press the push button “Output”, the DC output will be switched off and output LED will be off.
- Switch off the AC power switch.

These two simple tests , ensure that the power supply is largely working and further can be checked and tested for the other modes and features after going through manual.

In Description chapter , all the features and modes are explained in details. Request to go through each for better understanding and use.

## Chapter 4 Descriptions

### 4.1 Safety first - grounding

The power supply unit to be connected to the mains input as per the specification with firm protective earth grounding. The chassis of the unit is connected to ground potential. When the mains cord is connected, even in power off conditions, few components in power supply unit is still connected to the AC mains. To avoid any electrical shock, first remove the mains cord, wait for two to three minutes, before opening the instrument cover. Failure to do so will result in potential electric shock and serious injuries or could be fatal.

### 4.2 Input voltage

The power supply unit is designed for universal mains input. The mains input can be connected from 90V to 270 V 50 Hz / 60 Hz. While connecting to 200 to 250 V mains, mains cord of 250 V, 6 A can be used, however to connect it on lower voltages from 100V higher current rating 16 A power cord to be used. The power supply cord must be used as per the country specific approved mains cord to avoid damage to unit and personal hazard.

There is no external fuse in the unit, a safety fuse is installed inside the unit. In event of fuse blown, the fuse must be replaced only by Scientific authorised service personal.

When power supply unit is switched ON, its inrush current is limited by internal circuitry. Switching ON and OFF at faster rate, may result in over heating of current limiter, resulting higher inrush current.

The power supply is designed with active power factor correction, therefore the power factor is very close to unity, also the input mains current is almost sine wave. It's standby power is also very low, resulting in very high efficiency and low losses - lower heat generation.

### 4.3 Operating conditions

#### 4.3.1 Temperature and humidity

The power supply can be used safely at fully from 0 ~ 50 °C, with a condition that the surrounding free air movement is maintained for cooling. The normal humidity in ambient condition do not pose any problem, the heat produced in the instrument is sufficient to keep it dry.

In case of any condensation, allow the time to get it dry, before the instrument is switched ON and kept in use.

When power supply is mounted in 19" cabinet, ensure the free air movement. Industries and environment, with chemicals in air, e.g. chemical process industries, galvanizing industries, should take extra care to isolate the power supply unit by installing it in a clean room. This aggressive atmosphere, reacts with electronic component, damaging the parts and copper tracks etc. reducing the product life to standstill.

#### 4.3.2 Storage

The power supply unit when not in used, or for transportation, should be kept in dry place. It can be stored or transported from -20 ~ 70°C without any problems.

### 4.4 Thermal protection

The power supply unit has thermal protection, against internal temperature when exceeds the safe limit. This only happens when adequate air circulation is not provided or very high environment temperature or in case of any fault in the unit. When this condition occurs, the power supply output gets switched OFF, the front panel LEDs will display "OfP" and the OT signal appears at analog connector on the rear panel.



Allow some time to cool down the power supply unit, you may observe the cooling fan speed is high. Once the temperature reaches below the set safe limit, the speed of fan reduces and in few minutes and it may stop.

To switch ON the output, press the Output switch, output LED will glow and output will be ON. If the problem reappears, check for space for air movement and clear the space. If it still persists, contact Scientific or dealer close to you.



#### 4.5 Cooling

The power supply has two fans to cool down the internal temperature. The fresh air is taken from front side and exit on rear side. There is no ventilation holes on top and bottom side, this allows number of power supplies can be stack one over other.

The speed of the fan is governed by internal circuitry, it starts at predefined temperature and power when drawn.

#### 4.6 Output

The DC output of power supply unit is switchable to ON or OFF. This can be done by pressing the output switch on front panel or remotely using computer via RS232 / RS485 / USB/ LAN (optional if provided) using SCPI commands included in customer specific software. Through Interlock and RSD signal at analog programming connector at rear panel can switch OFF the output when used for safety or remote control.

The DC output is available on bus bar on the rear panel. The cable/ wire connected with the help of M5 bolt and nut provided.

The output can be either CV (constant voltage) with current limiting or CC (constant current) with voltage limiting. These power supplies are design for multi-ranging, meaning it follows a constant power curve within the specified maximum voltage and current for that model. For example model DCX20M80 allows the drawing load current of maximum 80 A up to 10 V and maintains CV mode. Similarly we can draw load current of 40 A at 20 V maintaining the CV mode. From 10 V to 20 V the maximum current will be decided internally such that the product of voltage and current is equal to approx. 800W. It follows the curve as shown below.

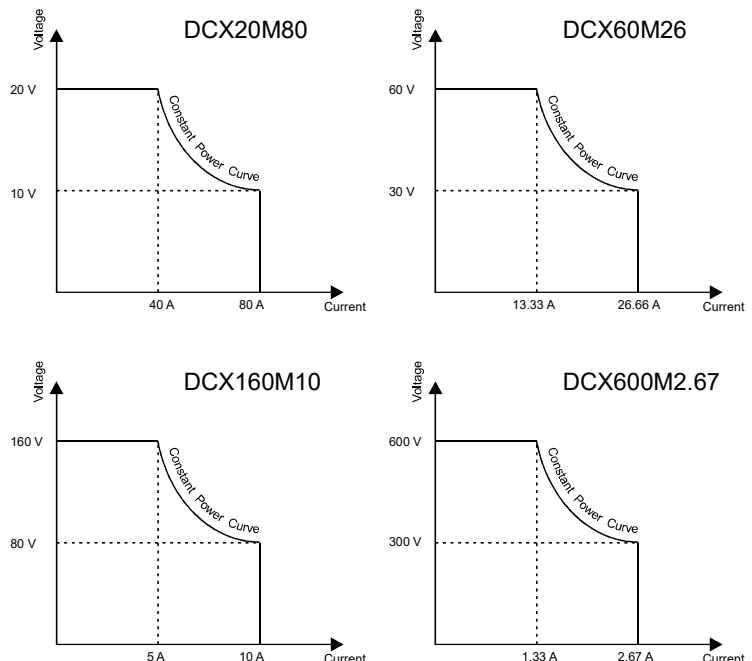

The transition of mode from CV to CC, depending on the load current is very sharp and respective LED indicators CV or CC will light on the front panel.

The power supply is fully protected against all type of overload conditions including short circuit at output. The power supply has very low ripple and noise. If needed, the ripple and noise has to be measured directly on

the sense terminals. To measure the ripple and noise very sensitive measuring instruments and probes are required. To measure the correct ripple amount, there are a few standardized methods for ripple and noise measurements. One of which is the JEITA-RC9131A standard.

#### 4.7 Connecting the load

##### Caution !

Before connecting any output cables, turn OFF the output. While output is ON, there is potential electric shock hazard where the power supply models having output voltage greater than 40 V.

While connecting the cable, observe the following steps for precaution.

- Switch OFF the unit, disconnect the mains from the unit.
- Wait until the output capacitor gets discharge, for approximately 2 minutes.
- Connect the appropriate output cable on the output bus.
- If required connect the sense wires at load points, else local sense can be used.

Select the output cable / wire with power rating higher than the power supply unit ratings. The size and length of the output cable is such that at maximum load the drop across each line conductor does not exceed the maximum permissible line drop of 1 V in DCX20M80, 2 V in DCX60M26 & DCX160M10 and 5V in DCX600M2.67/DCX1000M1.6. If the drop is more load regulation may not be maintained. In addition, there will be unnecessary power loss in cables.

The recommended cables for connecting the output are as below.

Model	Cable Size	Fixing Bolt size	Torque
DCX20M80	16 mm <sup>2</sup>	M5	20 Nm
DCX60M26	4 mm <sup>2</sup>	M5	20 Nm
DCX160M10	2.5 mm <sup>2</sup>	M5	20 Nm
DCX600M2.67 DCX1000M1.6	1.5 mm <sup>2</sup>	M5	20 Nm

The output cable is terminated with appropriate size of Copper lug. While making connection, place the copper lug directly to the bus, followed by washers and bolt. If the sequence is not followed, contact resistance will be introduced between the output bus and the cable, will cause excessive heat at bus. To reduce the output line inductance, keep both positive and negative cable close to each other.

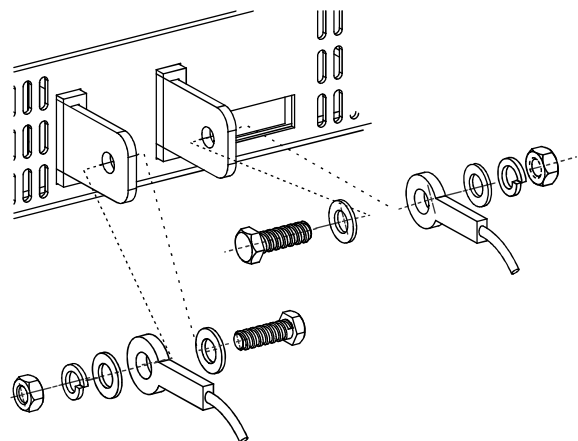

While connecting inductive loads, care must be taken to protect power supply unit from the spikes that may produced when output is switched ON and OFF. An appropriate rating of bypass diode should be connected at the output. The cathode of diode is connected to + ve output and anode to – ve output. The diode rating must be greater that the power supply voltage and current ratings. Similarly when the inductive motors are connected as load, that may give back emf. This back emf may cause a damage to the power supply, if protective measures are not taken. Connect a suitable surge suppressor of voltage of say 10 % to 15% of the maximum voltage of power supply unit.

Ensure that the output cable/ wire connected on output terminal are securely tightened before applying the power.

#### 4.8 Local and remote sensing

In most cases, local sensing is used. Power supply units are delivered with local sensing. On the rear panel, sense terminal block is provided. It has detachable connector plug. The plug is wired for local sensing as shown below.

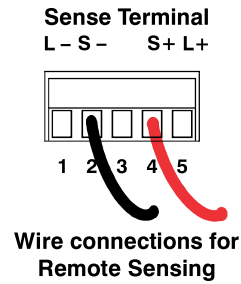
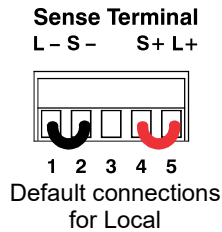

Sense Terminal connections

Pin 1	L -	Local sense -
Pin 2	S -	Remote sense -
Pin 3	NC	Not connected
Pin 4	S +	Remote sense +
Pin 5	L +	Local sense +

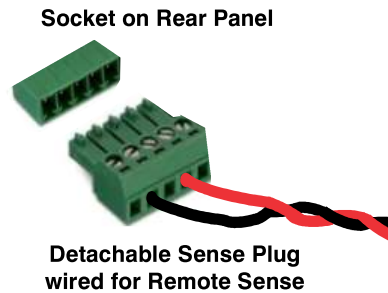

If the voltage regulation is to be maintained at load point, external wires are to be connected to sense points. Connect the wiring as shown above in the plug and insert the plug in remote sense socket. Before detaching or connecting the sense wires, switch off the power supply output, and ac mains to the unit. Wait for two minutes, until the output get discharged.

To keep the minimum external interference, the cables/ wires used to connect must be twisted pair. The wires should have good insulation to avoid any electrical contact with other equipments, ground or so. The power supply is floated and has no reference to other electrical circuit, unless physically connected. Such as grounded positive power supply where the negative output terminal is connected to protective earth potential, similarly negative power supply where the positive output terminal is connected to protective earth potential.

#### 4.9 Constant voltage and constant current mode

Power supply can be used in either constant voltage mode - CV, or constant current mode - CC. The mode is indicated by front panel LEDs. The DCX series has multi-ranging, the advantage is, it serve purpose of two models higher voltage - lower current and lower voltage - higher current in one unit. The curve it follows is constant power curve.

Care must be taken while measuring ripple current voltage , it must be measured on output directly, other wise few additional length of probe wire will add few mV of noise present in the field.

While using CC mode, do not use external Remote sense, otherwise it may add error in current set. While in CC mode DC fail signal will be generated usually.

#### 4.10 Hold up time

Hold up time is the duration of time to which the output is available, when the mains ac input is switched OFF. This time depends on the load connected, lower the load current drawn higher will be the duration. If no load is connected, you will observe the display is still ON for some time, when AC power switched to OFF. This time helps the control system in power supply to communicate the failure of AC to other systems connected.

#### 4.11 Over Voltage Protection

Over Voltage Protection (OV) protects the load / circuits connected to the set over voltage value. When OVP occurs, the output gets switched OFF. To enable the output, press the Output switch again. Thus it protects the load circuit, in the event of excess of output voltage in local or in remote mode of operation.

The minimum Over voltage can be set to approx. 105 % the set voltage or 1V. You can not set over voltage value lower than 1 V. The maximum over voltage can be set to approximately 105 % of the maximum settable voltage range.

When Over voltage protection is not required it should be set to the maximum value.

When over voltage occurs , the output gets switched OFF and display will show "OVP". To reset the power supply output, press the output ON/OFF switch. The power supply returns to previous state, if the voltage at output terminals diminishes, else again the over voltage protection comes into action.

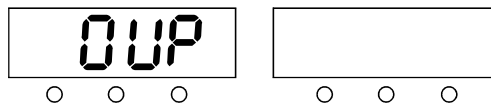

The setting of over voltage also works as over voltage limit, as it will not allow to set output voltage above

#### 4.12 Under Voltage limit

Under Voltage Limit (UV) limits the voltage setting. This useful in the event where test circuit input voltage should not go below certain level. By setting under voltage limit, it prevents accidental lowering the voltage. By using over voltage protection and under voltage limit, gives a window for sensitive circuits. Under voltage can be set from 0 V to 95% of the set output voltage. Under voltage can be set from front panel controls through Menu or from remote programming.

#### 4.13 Fold back protection

To protect the sensitive load from the set current value or from short circuit conditions, Fold back protection is used. This function can be enabled or disabled from the front panel in both cases output ON or OFF. When the function is enabled Fold LED will light. When the load current crosses set current or CC value, the output will be switched OFF. The display will show "FOLD" Once the output is switched OFF, it can be reset, by pressing Output push button.

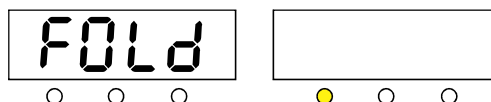

#### 4.14 AC fail

The power supply is in use and it's mains AC input fails or it is low or it was intermittent because of bad power conditions, the power supply display will show "ACF". It remains until the power supply has energy to support the load and the output charge gets discharged. This depends on the load connected, normally in seconds.

To switch power supply again, first resolve the mains connections, and then switch ON power supply.

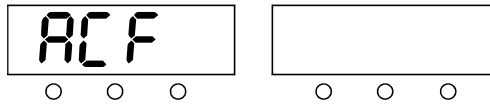

When power supply is in operation and you switch OFF the power supply, then also it will show the ACF on the display, however it is not a fault, just indication of AC mains switched OFF.

#### 4.15 Analog programming

This programmable power supply can be controlled from remote analog inputs apart from the front panel controls. These inputs can be voltage signals or through programming resistors. On rear panel DIP switch enables power supply to be controlled through analog connector. In analog programming output voltage and current can be set externally both or either.

The maximum voltage and current settable from analog programming is limited by front panel voltage and current settings. Preferably while using analog programming, set the front panel voltage and current to maximum.

SW 1

Rear panel switch SW1 set for remote external voltage programming, when DIP switch 9 is moved up. Current setting is from front panel.

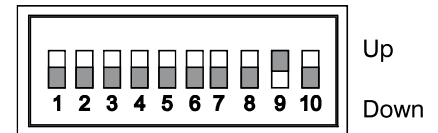

SW 1

Rear panel switch SW1 set for remote external current programming, when DIP switch 7 is moved up. Voltage setting is from front panel.

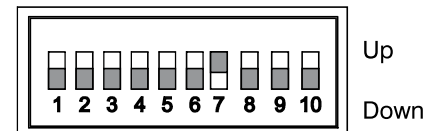

SW 1

Switch SW1 set for both voltage and current remote programming, DIP switch 7 & 9 moved up.

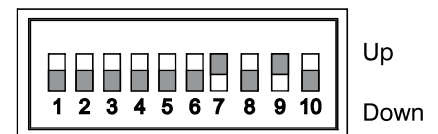

To maintain the power supply isolation and to prevent the ground loops, use an isolated programming source.

The power supply analog input and output signals are very sensitive and precise, any external disturbances may lead to errors in setting and measurements. Use a shielded cables for the analog control signals, if unshielded cable is use, provide EMI filters, suppressor to the cable. Keep the cable lengths as short as possible.

Remote analog programming / controlling can be done in following ways;

1. By applying voltage levels to voltage and current set. These levels are standardized on 5V or 10 V, which are selectable on DIP switch on rear panel for current programming pin 8 and for voltage programming pin 10.
2. Resistor programming, where a known resistance proportional to the desired voltage and current can be connected to adjust the voltage and current settings. The resistor programming is corresponds to 5k Ohms as full scale value or 10 k Ohms as full scale value. Resistor programming is set by DIP switch Sw1 pin 4 to Up. Programming resistors 5k or 10 k is selected by pin 10.

Apart from the setting the voltage and current, there are few status outputs are available which helps in remotely knowing the condition of power supply.

For measuring the voltage and current, monitor outputs are available in scale of 5 V or 10 V at pin 6 and 5 respectively, selectable on DIP switch. Note that, the Analog connector input signals for remote control, have reference to – ve output terminals and they are not floated. Wrong connection can cause earth loops, may cause faults. Care must be taken before connecting the analog connector after ensuring.

## Analog Connector Pin layout

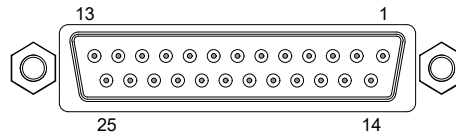

The Analog input output connector is D type 25 pin Female connector. Use appropriate mating connector always to give firm contacts and reliable connections.

### 4.16 Description of analog connector pins and their application

Pin 1 : Interlock + & Pin 14 Interlock –

The interlock function is enabled by selecting from switch SW1 - Pin 2 is set to UP. Pin 1 of analog connector is passed through the external control switch to Pin 14 of analog connector. The power supply is kept in output ON. When the external switch is ON (shorted) the output will be available, if external switch is OFF (open) the output will be switched OFF.

It can be used in combination with door switch contacts, for safety in process room, cabinet, other application is as a Emergency Stop Switch.

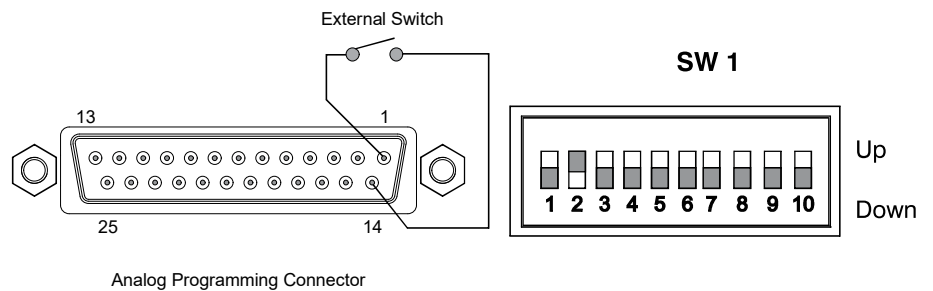

Pin 2 , Pin 3 , Pin 12, Pin 22, Pin 23 : Ground Analog Programming.

Pin 4 : Reserved , do not connect any external circuitry !

Pin 5 : Over Voltage status

When the over voltage occurs the status at pin 5 is updated, it goes low.

Pin 6 : Over Temperature status

When the inside temperature of the power supply unit increase beyond the set safe temperature, power supply output gets switched OFF and the status at pin 6 is updated. It goes low on over temperature, and remains until the normal conditions is attained.

Pin 7 : Reference voltage output 5.1 V

When power supply is to be controlled through remotely using external potentiometers, this reference voltage can be used as reference supply to potentiometers. The potentiometer value must be 10 k Ohms or higher to avoid any loading effect on reference voltage.

Pin 8 : Not connected

This pin is not used in this model, reserve for future use if any.

Pin 9 : Voltage programming input

In remote analog programming, to control the output voltage, V programming set value is fed to pin 9. Programming voltage of 5 V or 10 V reference is selected from SW1 DIP switch at rear panel. The relation between the Vset and Vout is ;

for 5 V programming ;

$$V_{set} = (5 \times V_{out}) / V_{rated}$$

where  $V_{set}$  is voltage to be fed to pin 9 ;  $V_{out}$  is required output voltage ;  $V_{rated}$  is the rated output voltage of power supply unit

e.g. : in DCX600V2.67 model  $V_{rated}$  is 600V , and we wish to set output to 400V, then  $V_{set}$  will be  $(5 \times 400) / 600 = 3.33 \text{ V}$

for 10 V programming ;

$$V_{set} = (10 \times V_{out}) / V_{rated}$$

where  $V_{set}$  is voltage to be fed to pin 9 ;  $V_{out}$  is required output voltage ;  $V_{rated}$  is the rated output voltage

e.g. : in DCX600V2.67 model  $V_{rated}$  is 600V , and we wish to set output to 400V, then  $V_{set}$  will be  $(10 \times 400) / 600 = 6.66 \text{ V}$ .

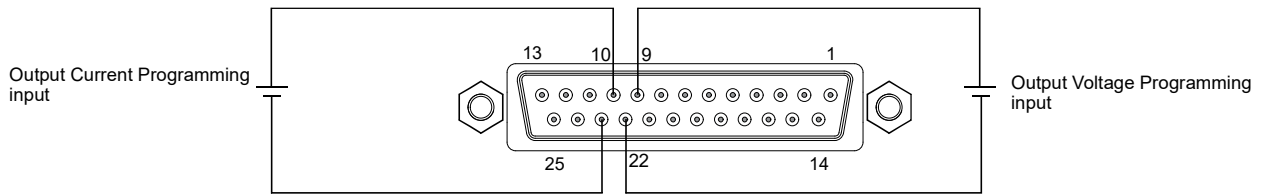

Pin 10 : Current programming input

In remote analog programming, to control the output current  $I_{programming}$  set value is fed to pin 10. Programming voltage of 5 V or 10 V reference is set from SW1 DIP switch at rear panel. The relation between the  $I_{set}$  and  $I_{out}$  is ;

for 5 V programming ;

$$I_{set} = (5 \times I_{out}) / I_{rated}$$

where  $I_{set}$  is voltage to be fed to pin 10 ;  $I_{out}$  is required output current ;  $I_{rated}$  is the rated output current of power supply unit

e.g. : in DCX600V2.67 model  $I_{rated}$  is 2.67A , and we wish to set output to 1.00A , then  $I_{set}$  will be  $(5 \times 1.00) / 2.67 = 1.87 \text{ V}$ .

for 10 V programming ;

$$I_{set} = (10 \times I_{out}) / I_{rated}$$

where  $I_{set}$  is voltage to be fed to pin 10 ;  $I_{out}$  is required output current ;  $I_{rated}$  is the rated output current of power supply unit

e.g. : in DCX600V2.67 model  $I_{rated}$  is 2.67A , and we wish to set output to 1.00A , then  $I_{set}$  will be  $(10 \times 1.00) / 2.67 = 3.74 \text{ V}$ .

Pin 11 : Voltage monitoring output ; Pin 24 : Current monitoring output

In remote analog programming, you can monitor the output voltage and current on external measuring device e.g. on Digital Multimeter. The monitor output can be selected in reference to 5 V or 10 V from the SW1 DIP switch at rear panel. These outputs are with reference Pin 12 and Pin 23 ground / return path. The relation between the  $V_{monitor}$  and  $V_{out}$  is ;

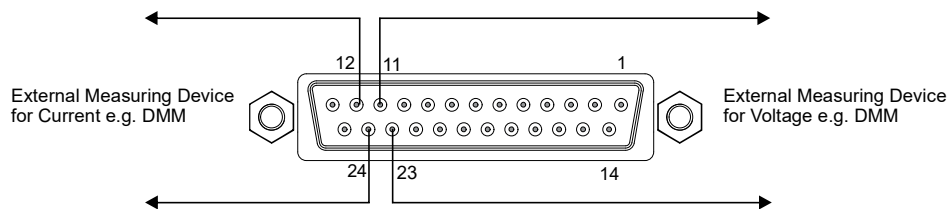

$V_{monitor}$  for 5 V reference ;

$$V_{\text{monitor}} = (5 \times V_{\text{out}}) / V_{\text{rated}}$$

where  $V_{\text{monitor}}$  is output voltage from pin 11 ;  $V_{\text{out}}$  is output voltage ;  $V_{\text{rated}}$  is the rated output voltage of power supply unit  
 e.g. : in DCX600V2.67 model  $V_{\text{rated}}$  is 600V , and if the output voltage is 400V, then  $V_{\text{monitor}}$  will be  $(5 \times 400) / 600 = 3.3 \text{ V}$  .

$V_{\text{monitor}}$  for 10 V reference ;

$$V_{\text{monitor}} = (10 \times V_{\text{out}}) / V_{\text{rated}}$$

where  $V_{\text{monitor}}$  is output voltage from pin 11 ;  $V_{\text{out}}$  is output voltage;  $V_{\text{rated}}$  is the rated output voltage of power supply unit  
 e.g. : in DCX600V2.67 model  $V_{\text{rated}}$  is 600V , and if the output voltage is 400V, then  $V_{\text{monitor}}$  will be  $(10 \times 400) / 600 = 6.6 \text{ V}$  .

$I_{\text{monitor}}$  for 5 V reference ;

$$I_{\text{monitor}} = (5 \times I_{\text{out}}) / I_{\text{rated}}$$

where  $I_{\text{monitor}}$  is output voltage from pin 24 ;  $I_{\text{out}}$  is output current ;  $I_{\text{rated}}$  is the rated output current of power supply unit  
 e.g. : in DCX600V2.67 model  $I_{\text{rated}}$  is 2.67A , and if the output current is 1.33A, then  $I_{\text{monitor}}$  will be  $(5 \times 1.33) / 2.67 = 2.5 \text{ V}$  .

$I_{\text{monitor}}$  for 10 V reference ;

$$I_{\text{monitor}} = (10 \times I_{\text{out}}) / I_{\text{rated}}$$

where  $I_{\text{monitor}}$  is output voltage from pin 24 :  $I_{\text{out}}$  is output current;  $I_{\text{rated}}$  is the rated output current of power supply unit  
 e.g. : in DCX600V2.67 model  $I_{\text{rated}}$  is 2.67A , and if the output current is 1.33A, then  $I_{\text{monitor}}$  will be  $(10 \times 1.33) / 2.67 = 5.0 \text{ V}$  .

Pin 13 : CV / CC status

The status for CV and CC is

Power supply when in CV : Low ; Power supply when in CC : High

Pin 15 : Remote shut down On/Off

In remote programming, the output of power supply can be remotely switched OFF by applying TTL ( 5V) at pin 15 of analog connector , with reference to ground at Pin 2. The power supply remain switched OFF, until the TTL voltage is goes 0V.

Pin 16 : Power supply OK

When the power supply is working and there is no fault , the power supply status is updated on pin 16 as,

Power is OK : High ; Power supply is not OK : Low

Pin 17 : DC output ON

The status for DC output is updated at pin 17 as

Power supply Output ON : High ; Power supply Output OFF : Low

Pin 18 : Not connected

This pin is not used. Please do not connected any circuit to this pin.

Pin 19 : AC fail status output



While ac mains to the power supply is not available due mains failure or power supply mains switch is switched OFF the status is updated on pin 19.

AC mains available : High  
AC mains not available : Low

Pin 20 : DC Fail status output

If the output voltage drops or increases 5 % above the set voltage, the status is updated at pin 20 as,

DC output within 5 % of set value : High  
DC output beyond 5 % of set value : Low

Pin 21 : Remote Control status output

When power supply unit is controlled remotely, the status updated at pin 21 as,

Power supply is in remote control : High  
Power supply is in local control : Low

Pin 25 :Not connected

#### 4.17 Safe start - auto start mode

When the power supply AC mains switch is pressed, ON, the DC output state can be controlled. In some application where the output to regain it's original position as when it was switched OFF, is possible by selecting the mode from rear panel DIP switch SW1 setting.

To enable the output to previous state (before the power switch was OFF) move switch 3 to up.

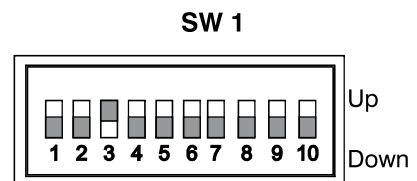

To disable the output or to keep the output OFF on mains AC switch ON, keep the switch 3 to down.

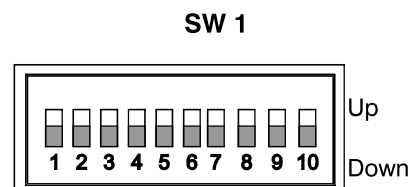

#### 4.18 Last save memory

When power supply is switched OFF , it records the setting and save it in memory. When next mains switched ON , the save setup is loaded.

Following settings are saved, with each mains switch OFF.

1. Set voltage
2. Set current
3. Over voltage level
4. Under voltage level
5. Fold setting
6. Baud rate
7. Communication mode
8. Power supply address
9. Last status of Output ON or OFF
10. Front panel locked / unlocked

#### 4.19 Front panel locking

You can lock the front panel of power supply, to protect the settings against any accidental change of functioning of any push button pressed or encoder settings.

#### 4.20 Remote control mode in RS232, RS485 and USB

The DCX series power supplies can be remotely controlled over RS232, RS485 and USB. End user can use SCPI commands in their control software. All the front panel functions are available on remote host. When the power supply unit is remotely accessed, all the front panel control push buttons gets locked, except push button "Rm". By pressing push button "Rm", power supply returns to local control mode, and can be controlled from front panel. Remote also can be disabled from remote host.

To connect the power supply unit to remote host use appropriate connecting cable. The connecting ports are on rear panel of the unit. The cable wiring diagram is given in this manual helps to fabricate if not available and to ensure that the correct cable is being used.

From the front Menu setting, it is possible to select the interface to use RS232, RS485 or USB, along with the respective parameter settings.

#### 4.21 Connecting load

The load is connected on rear panel bus of power supply unit. The connecting wires/ cables should be of appropriate size, with good insulation. The power supply has floated output, this allows, if required the either of terminal can be connected to ground as per the load requirements. This means a positive or negative power supply can be configured.

While connecting load wire / cables, ensure that the power supply is switched OFF, wait for few minutes, until the output charge is discharged. Disconnect the mains, connecting the output wires and sense wires in local or remote sense as the case may be. Never change or remove the sense wire in power supply ON conditions, doing so it may cause a damage to the power supply unit as well as it's dangerous to do so for the person working on it.

##### Connecting single loads

The load can be connected in either in local sense or in remote sense mode. In case of local sense mode the sense points are at output bus, whereas when precise regulation is required at load points, the sense wires are connected across the load.

When the regulation is critical, remote sense to be used. Remove the local sense connections and move these sense wires to load end as shown in figure. While in remote sense, the sense wires should be twisted and or to be shielded to avoid any influence of surrounding noise. The sense wire length should be optimized to get the shortest length.

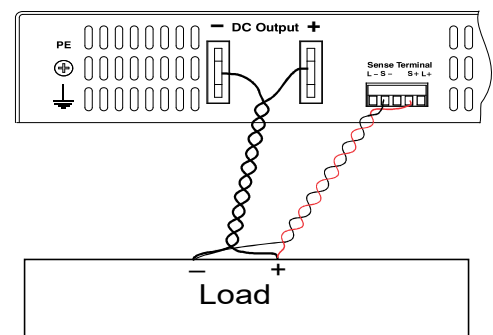
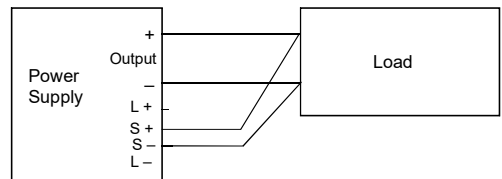
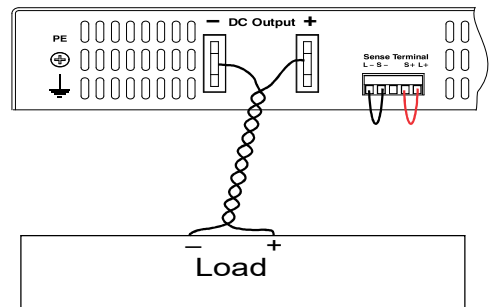
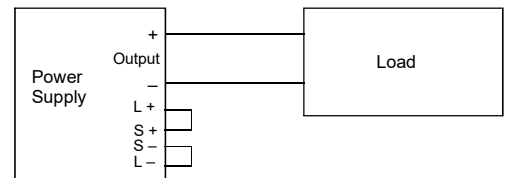

## Connecting multiple load

When connecting multiple load, the loads can be connected directly on the output bus of power supply with local sensing or the power supply output can be connected to common bus, on which the multiple loads can be distributed. The regulation at common bus can be maintained by connecting the remote sense wires on common bus.

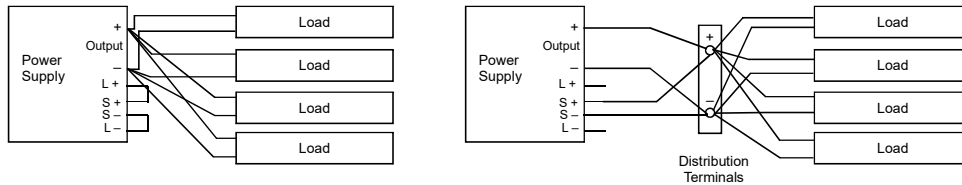

## 4.22 Connecting power supplies in series & parallel

To increase the current or voltage rating of power supply system, it is possible to connect the power supplies in series for increasing the voltage rating and connecting in parallel to increase the current rating. While connecting ensure that the models are same. Do not connect other models in series or in parallel, else there are possibilities of damaging the power supply units.

When the power supplies are connected in series the maximum output voltage will be the addition of all the units connected in series. Total maximum added output should be less than 600V.

In Remote control in analog programming care must be taken, the programming voltage fed has reference to output negative terminal and when the power supplies are in series the input programming voltage must be isolated else the power supplies connected will be short circuited through analog programming connectors return points / reference grounds.

When the power supplies are connected in parallel the current capacity gets multiplied by the number of units in parallel. There is no limit on number of power supplies connected in parallel.

## 4.23 Power supply as battery charger

The DCX series power supplies can be used as battery charger, CV/CC mode regulates the charging current. To protect the power supply, use a circuit breaker in series with charging cable, in event of excess current or reverse polarity the circuit breaker will disconnect in very short time. The circuit breaker should have double the battery voltage and fast acting (normally type Z). To protect the accidental polarity reversal current large amount will flow through the power supply, which will damage the power supply, to avoid, a bypass diode is connected in parallel to output terminal of power supply. The diode should be of higher rating and should have high heat dissipating capability.

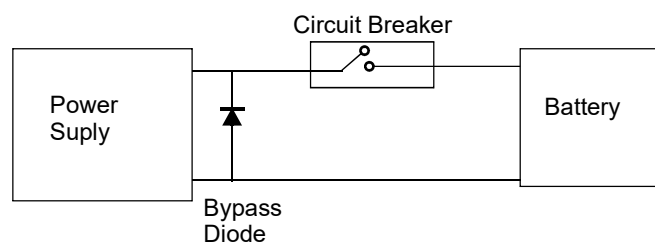

## 4.24 Local Area Network (LAN)

The Local Area Network (LAN) in DCX Series power supply allows user to remotely program, measure and check the status of power supply. Followings are the features.

- Ethernet RJ-45 connector, Link and Activity LED on RJ-45 connector
- Communicate over any standard TCP/IP network
- TCP socket supported
- View IP address, Sub net mask, Gateway and PORT number using SCPI command
- User can update IP address, Subnet mask and Gateway using SCPI command via USB/RS232/RS485
- Auto selects fastest of 10Base-T or 100Base-T networks (10 or 100 Megabits per second)
- Any IP can be assigned

## Chapter 5 Menu controls

The most of the functions are enabled and controlled through Menu setting. The front panel has six push button switches and two encoders.

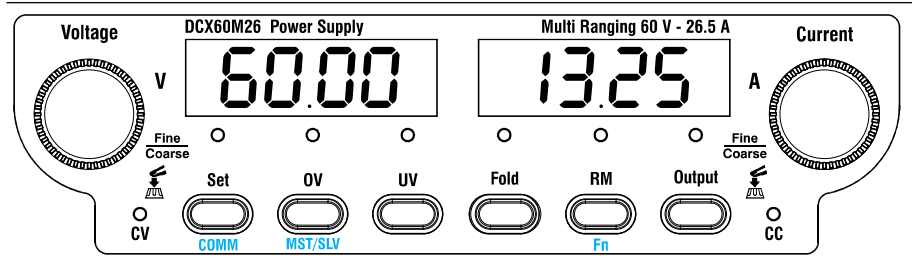

The front panel controls are ergonomically arranged to ease in operation. Apart from the two encoders on either sides named as Voltage and Current are used to select the modes and parameters, while in Menu selection.

The text controls written in black above the push buttons offers direct settings in regular use of power supply. The second line text in Blue/Cyan color offer control for setting communication modes and parameters. They are IO selections and their parameters for example setting address, baud rates etc.

On following pages, menu settings are described. Follow the sequence of pressing of push buttons as described. By pressing any of push button assigned function is selected. If you press it again, the display will return the previous displayed value with updates. If the push button is left as it is, menu will get exit automatically after predefined time, it's approx. 10 seconds.

### 5.1 Power ON switching

With default or factory setting, when the power supply is switched ON, the display indicates "OP OFF"

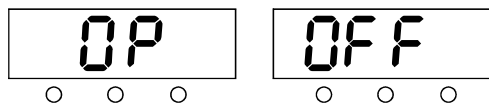

Functions are explained below;

**5.2 Voltage & Current setting :** To set the desired voltage or current, press "set" push button, the set LED will light and the display will show previous voltage current set values.

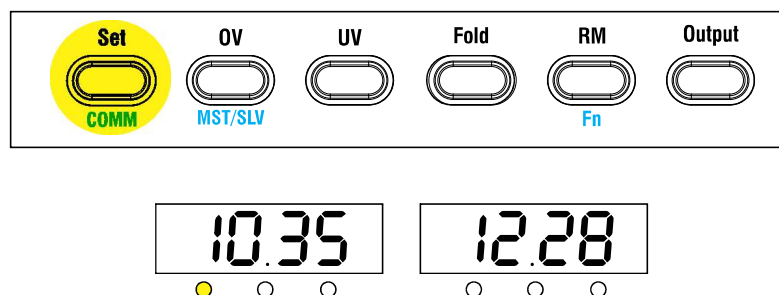

To set the new value of voltage, rotate Voltage encoder until the desired value. Similarly to set the new value

of current, rotate Current encoder until the desired value.

The voltage and current can also be set, changed in output ON condition.

The encoder when moved one step changes value on third digit (coarse), to increase the resolution, press the encoder switch again, the resolution will be changed to second digit (medium), to increase the further to first digit (fine) press encoder once more. With next pressing encoder will return to resolution at third digit. The default step resolution is at third digit.

### 5.3 Over Voltage setting

To set the Over Voltage protection value, press "OV" push button. OV LED will light and display will show the previous over voltage set value.

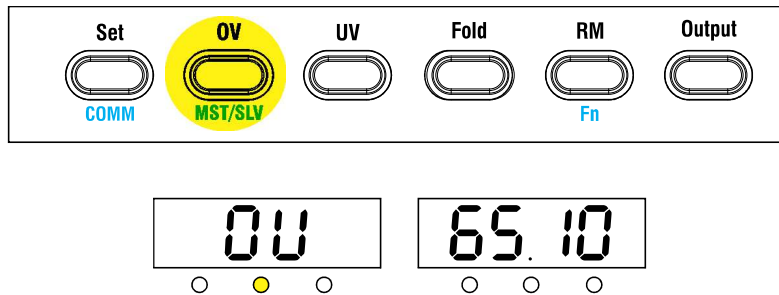

To set the new over voltage protection value, rotate voltage encoder. The new changing value is displayed on right window. You can change the encoder resolution in coarse, medium or fine by pressing voltage encoder switch.

The minimum Over voltage can be set to approx. 105 % the set voltage or 1V. You can not set over voltage value lower than 1 V. The maximum over voltage can be set to approximately 105 % of the maximum settable voltage.

When Over voltage protection is not required it should be set to the maximum value.

### 5.4 Under Voltage setting

To set the Under Voltage protection value, press "UV" push button. UV LED will light and display will show the previous under voltage set value.

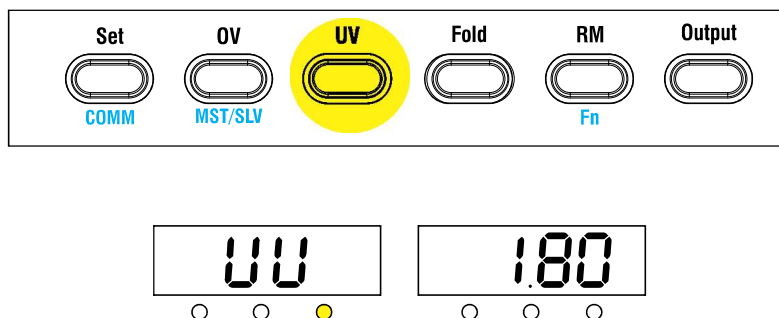

To set the new under voltage limit value, rotate voltage encoder. The new changing value is displayed on right window. You can change the encoder resolution in coarse, medium or fine by pressing voltage encoder switch. The maximum under voltage can be set to approx. 95 % the set voltage. The minimum under voltage value can be set to 0 V.

### 5.5 Fold back protection

To enable Fold back protection, press “Fold” push button. The Fold LED will light. To disable the Fold back protection, press “Fold” push button, the Fold LED will OFF. This function can be enabled or disabled in output ON or OFF conditions.

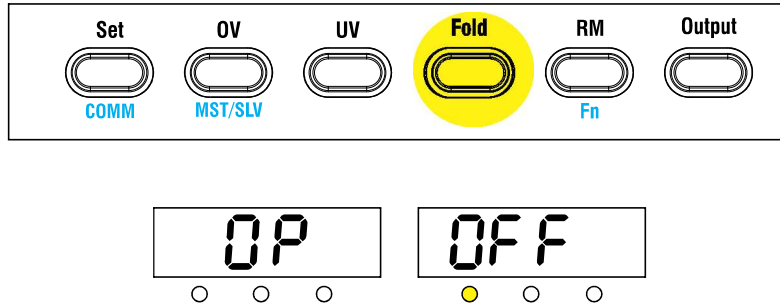

### 5.6 Output On / OFF

To enable the output, press “Output” push button. The output LED will light. The display will show the measured output voltage and current. While the output is ON, you can change the voltage and current by encoders. You can also access “Set”, “OV”, “UV” and “Fold” menu in output ON state.

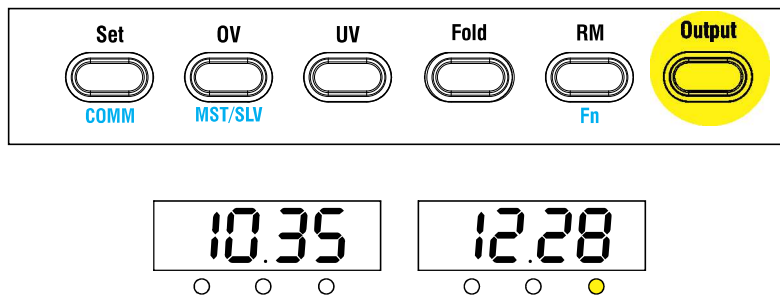

### 5.7 Communication set menu

The communication menu is selected by pressing the “Fn” push button, followed by “COMM” push button. This menu is active only in output OFF condition and Local mode.

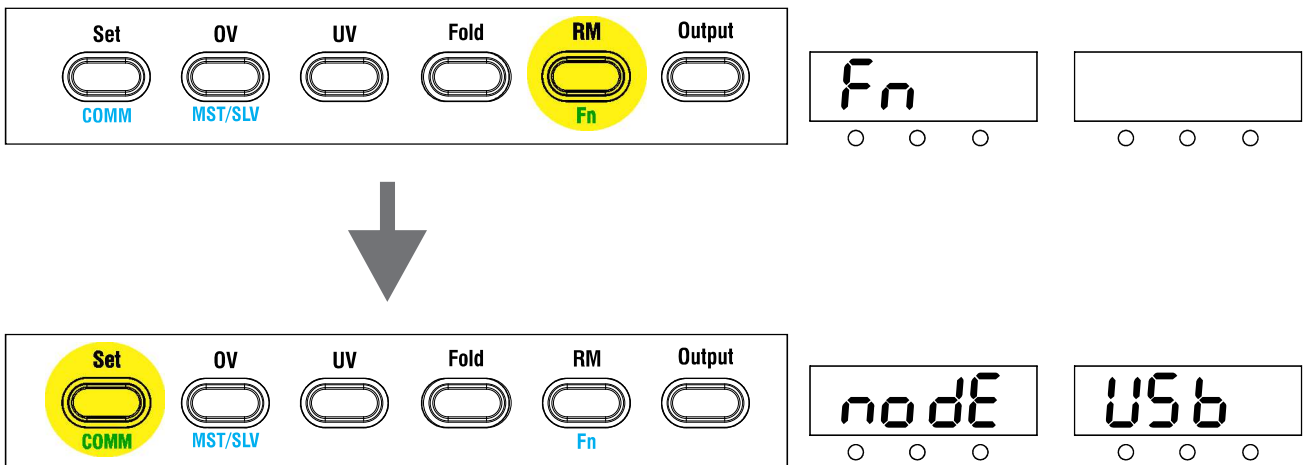

By varying voltage encoder you can select mode , baud and address.

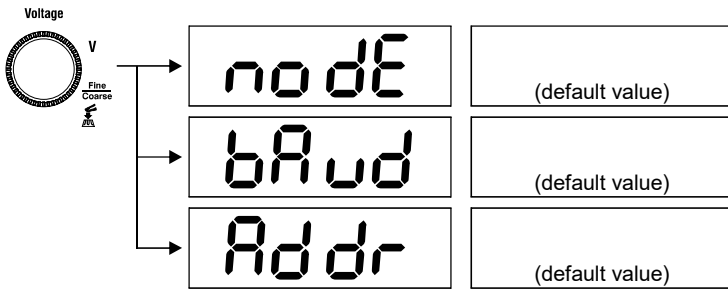

By varying current encoder mode parameters can be changed when mode is selected, from USB, RS232, RS485 or LAN.

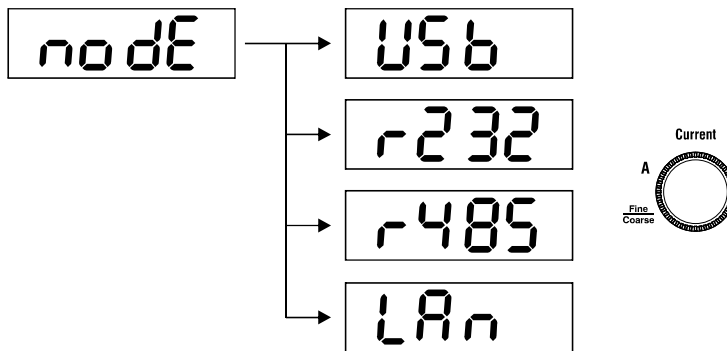

By varying current encoder baud parameters can be changed from 1200,2400, 4800, 9600 and 19.2k when baud is selected.

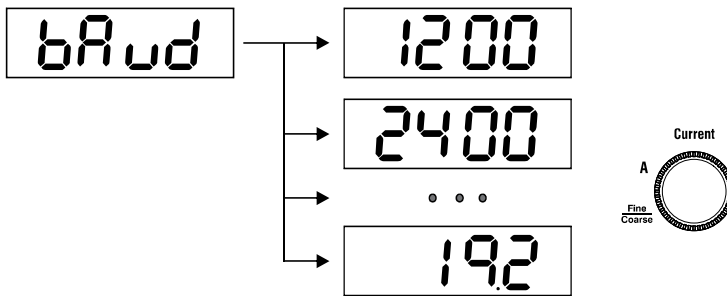

By varying current encoder address can be changed when Address is selected. The address range is 1 to 30.

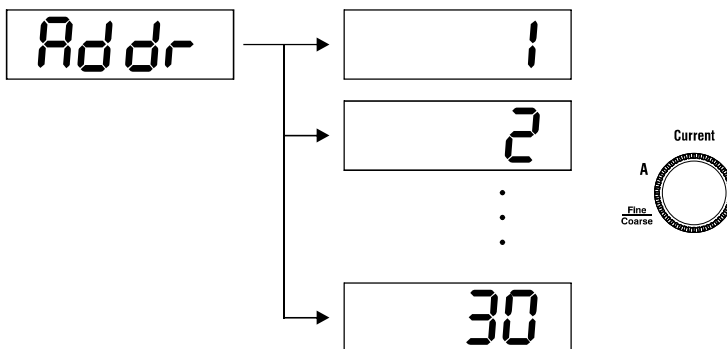

## Setting LAN Parameters

Select Mode to LAN with voltage encoder knob.

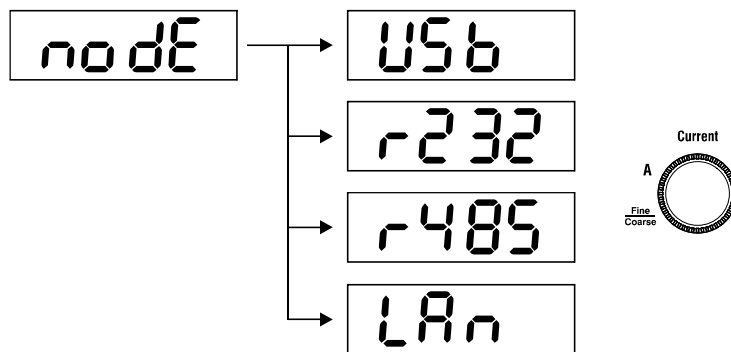

Default LAN settings are ;

IPAddress: 192.168.100.29

Subnet Mask : 255.255.255.0

Gateway : 192.168.100.1

Port : 5000

LAN parameters can be changed from USB, RS232 or Rs485. Connect the port with the help of appropriate cable, and send the following commands, using any GUI application such as Terminal, Hercules etc.

IPAddress:

SO:IP xxx.xxx.xxx.xxx

(Ex. SO:IP 192.168.100.26)

Subnet Mask:

SO:Sn xxx.xxx.xxx.xxx

(Ex. SO:SN 255.255.255.0)

Gateway

SO:GW xxx.xxx.xxx.xxx

(Ex. SO:GW 192.168.100.1)

After setting all the parameters, the power supply unit must be restarted to update / applied settings.

To control the power supply unit, all the SCPI commands can be used. Refer "Chapter 6 Communication interface protocol" , page 42.



### 5.8 Master / Salve menu ( Reserved for future)

The Master / Salve menu is selected by pressing the “Fn” push button, followed by “MST/SLV” push button. This menu is active only in output OFF condition and in Local mode.

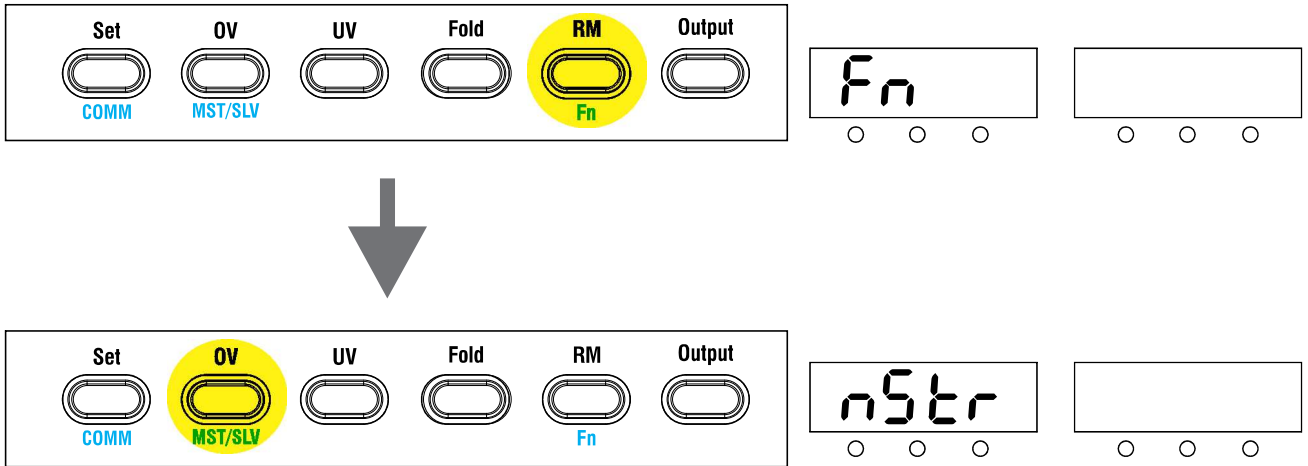

By varying voltage encoder you can select Master or Salve.

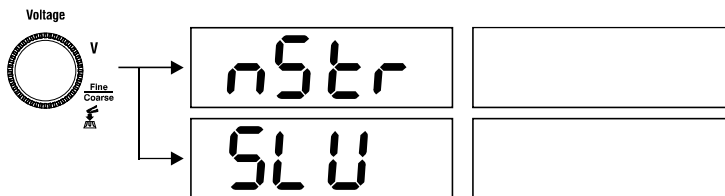

### 5.9 Front panel lock

You can lock the front panel of power supply, to protect the settings against any accidental change of functioning of any push button pressed or encoder settings.

To select this function, press push button “Fn” and then “UV” in sequence, the display will show FP in left window and Loc in right window.

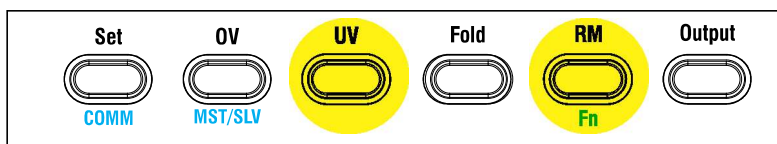

To unlock the front panel , press push button “Fn” and then press “UV” in sequence, the display will show FP in left window and UnLc in right window. the panel will be unlocked.

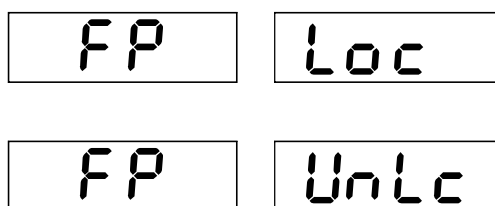

## Chapter 6 Communication interface protocol

The power supply series DCX800 has communication command words, which includes some of SCPI (Standard Commands for Programming Instruments).

Followings are guidelines, to enable End User program to set up communication between the power supply unit and the host (computer).

- The syntax commands may be sent, in any case , lower, upper or mixed.
- The first command to be sent, is power supply unit address.
- Commands with ? is a query and power supply unit sends a response to it.
- Space between the command and argument is denoted by <sp>.
- The data string is 8 bit, 1 start bit and 1 stop bit.
- No parity bit is used.
- End of message is Carriage Return (ASCII 13) or \r\n .
- On every command sent to power supply unit is acknowledged by OK or with argument reply.

### 6.1 SCPI Commands:

These commands are not case sensitive, use complete SCPI text command in full. The power supply when connected in remote control, the first command is CH <PS\_address>. Setting the power supply address is explained in xxxxx on page xxx. The front panel of power supply will be locked and Remote LED will light, which indicates, the power supply is in remote control mode.

#### 6.1.1 . Remote mode enable

This command is used to connect the power supply in remote mode.

Syntax: CH <PS\_address>

Power supply returns : CH < 1 > ON

PS\_address is power supply address from 1 to 32. Default address value is 1.

#### 6.1.2 Remote mode disable

This command is used to switch the Power supply in local mode form remote mode

Syntax: EXIT

Power supply returns : CH < 1 > OFF

#### 6.1.3 Read instrument identity

This command used to identify the unit connected on remote, returns the Instrument Model number.

Syntax: \*IDN?

Power supply returns: DCX60M26 Vx.xx

Examples shown above is in case of DCX60M26. Return reply indicates instrument model DCX60M26 is connected.

#### 6.1.4 Set output voltage

This command is used to set the output voltage of power supply.

Syntax: SO:VO <xx.xxxx>

Power supply return : OK

xx.xxxx is set voltage numeric value in Volts, e.g. 10.0500. It may be full number or with decimal values. The set value is displayed on the power supply front panel for few seconds and disappears. The display returns to its previous position.

### 6.1.5 Set output current

This command is used to set the output current of power supply.

Syntax: SO:CU <xx.xxxx>  
Power supply returns : OK

xx.xxxx is set current numeric value in Amperes. It may be full number or with decimal values. The set value is displayed on the power supply front panel for few seconds and disappears. The display returns to its previous position.

### 6.1.6 Set Under Voltage limit

This command is used to set the under voltage limit.

Syntax: SO:UV <xx.xxxx>  
Power supply returns : OK

xx.xxxx is set voltage numeric value in Volts. It may be full number or with decimal values. The UV setting range is from 0V to 5% less than the present set value e.g. in DCX600M1.6 the set value is 400 V , the UV can be set from 0 V to 380V ( 400V -5% ). The set value is displayed on the power supply front panel for few seconds and disappears. The display returns to its previous position.

### 6.1.7 Set Over Voltage protection

This command is used to set the over voltage protection.

Syntax: SO:OV <xx.xxxx>  
Power supply returns : OK

xx.xxxx is set voltage numeric value in Volts. It may be full number or with decimal values. The OV setting range is from 5% above the present V set value to maximum of Vrated approx. e.g. in DCX600M1.6 the V rated is 600V , and the present set value is 400V then OV can be set from 420V ( 400V + 5% ) to 600V. The set value is displayed on the power supply front panel for few seconds and disappears. The display returns to its previous position.

### 6.1.8 Set output On / OFF

This command is used to ON/OFF the output of power supply

To switch ON the output ;

Syntax: OUP 1  
Power supply returns : OP ON

To switch OFF the output;

Syntax: OUP 0  
Power supply returns: OP OFF

### 6.1.9 Read set voltage

This command returns the set voltage of power supply.

Syntax: SO:VO?  
Power supply returns: xx.xxxx

for example 10.0000, this means the output voltage is 10.0000 V.

#### **6.1.10 Read set current**

This command returns the set current of power supply.

Syntax: SO:CU?  
Power supply returns : xx.xxxx

for example 10.0000, this means the output current is 10.0000 A.

#### **6.1.11 Read Under Voltage set limit**

This command returns the under voltage set limit of power supply.

Syntax: SO:UV?  
Power supply returns : xx.xxxx

for example 10.0000, this means the under voltage set is 10.0000 V.

#### **6.1.12 Read Over Voltage protection set**

This command returns the over voltage protection set of power supply.

Syntax: SO:OV?  
Power supply returns : xx.xxxx

for example 10.0000, this means the over voltage protection is set to 10.0000 V.

#### **6.1.13 Read measured output voltage**

This command returns the measured output voltage of power supply.

Syntax: VOLT?  
Power supply returns : xx.xxxx

for example 10.0000 is measured output voltage.

#### **6.1.14 Read measured output current**

This command returns the measured output current of power supply.

Syntax: CURR?  
Power supply returns : xx.xxxx

for example 10.0000, this means the measured output current is 10.0000 A.

#### **6.1.15 Fold back enable / disable**

This command is used to ENABLE/DISABLE the fold back protection of power supply.

To enable Fold back;

Syntax: FOLD 1  
Power supply returns : FOLD ON

To disable Fold back;

Syntax: FOLD 0

Power supply returns: FOLD OFF

### 6.1.16 Read measured output power

This command is used to read the measured output power of the power supply in watts.

Syntax: POWER?

Power supply returns : xx.xxxx

for example 500.000, this means the total output power delivered is 500.000 watts.

### 6.1.17 Read measured internal temperature

This command is used to read the internal temperature of power supply.

Syntax: TEMP?

Power supply returns : xxx.x °C

for example 100.0°C, this means the internal temperature of power supply unit is 100.0°C.

### 6.1.18 Status ?

This command returns the hex value of status.

0xXX

Status Register



Bit	Status	OK	Fault
0	Interlock Status	1	0
1	PS OK Status	1	0
2	ACF Status	1	0
3	OTP (Over temperature )	1	0
4	OVP (Over Voltage)	1	0
5	FOLD Status	1	0
6	OP ( Output ON/OFF) Status	1	0
7	CV-CC Status	CC=1	CV=0

### 6.1.19 Read LAN configuration

This command is used to read the LAN / Ethernet configuration.

Syntax: ETH:Config?

This command returns LAN / Ethernet configuration details. e.g.

Port: 5000  
IP : 192.168.100.29  
SB:255.255.255.0  
GW:192.168.100.1

## Chapter 7 Maintenance

There are no user serviceable part inside the power supply unit. The instrument is carefully tested and calibrated using standards traceable to National Laboratories. To prevent electrical shock, do not remove cover. If you have any questions concerning the maintenance or operation, contact Scientific Customer Support or nearest dealer to you.

No User internal calibration is required during the operational life time of power supply unit. Do not open the power supply unit cover, there exists high voltage points on the PCB circuitry. Only qualified and trained technical person understanding the potential hazards is expected to handle the inside faults if any. In such case we recommend to send the power supply unit to Scientific for service and repairs.

In case of power supply failure, when it needs service / repairs , there is no User repairs or replaceable parts inside the power supply unit. No User replaceable parts are listed in this manual. Repairs are only made by manufacturer or by authorized service facilities.

No periodic maintenance is required except to take care of your instrument by cleaning the exterior of the instrument regularly with a dusting brush. Dirt which is difficult to remove on the casing & plastic parts, can be removed with a moist cloth ( 99% water, 1% mild detergent) spirit or washing benzene(petroleum ether) can be used to remove greasy dirt. Under no circumstances the cleaning fluid should get into the instrument. The use of cleaning agents can attack the plastic & paint surfaces.

### 7.1 Troubleshooting

These power supply units are designed for continuous use, as such there are very less probabilities of failures. However, in the event of failure following first hand troubleshooting will help to diagnosis the problem. If the problem is still not solved, please contact nearest dealer to you or Scientific Customer Support giving full details.

Problem Symtoms		Checks and solutions	
1	No Output	1.1	When power switch is ON no display , no output. Check the mains cord continuity. if faulty replace.
		1.2	Display is ON, but no output even pressing output button to ON. Check if the output cable is shorted. if faulty replace.
		1.3	Check if sense block wires are open or wrongly wired. if yes place it correctly S+ to positive and S- to negative bus outputs.
		1.4	Check if voltage and current both encoders are set to zeroes, if yes move encoders to desired values.
		1.5	Check the OV LED lights, if yes over voltage has occurred, remove the conditions and reset the over voltage protection by pressing Output push button.
		1.6	Check for the Over temperature conditions, if yes remove the conditions and reset the output by pressing output push button.
		1.7	Check for fold back, if yes remove the condition , or disable the fold back mode.

	Problem Symtoms	Checks and solutions	
2	Voltage and or Current encoder does not work	2.1	Check if the power supply Remote LED is ON, if yes press and release Remote mode.
		2.2	Check if voltage and or current analog programming is selected from rear panel SW1 DIP switch setting. if yes, move the switch to local mode.
		2.3	Check if the front panel is locked, if locked , release it from Menu setting
		2.4	Check if the over voltage and under voltage limits
3	Remote Programming does not work	3.1	Check if the power supply unit IO connecting cable is correct and in working condition, if faulty replace it.
		3.2	Check if the Remote LED on front panel is OFF, this means remote is not enabled from remote host.
		3.3	Check if , in analog programming, DC offset is present in the programming voltages. if yes , reduce it or use floated / isolated programming input signals.
4	Output voltage is higher than set value	4.1	Check if the sense wires are open at sense block or at load end if used remote sensing. If yes re-wire the same.
		4.2	Check if the output cable is too long and of lower rating. Reduce the output cable to the possible length and increase the cable capacity using higher cross section cable.
5	High Ripple voltage present of output	5.1	Check if the sense wires are open and output cable is too long. if sense wires open, re-connect the sense wire.
		5.2	Check if Remote sense is used and sense wires are too long and hanging. if yes, optimize the wire lengths and use twisted pair for sense wires.
6	Load current not shared in Master- Slave mode	6.1	Check if the connecting Master-Slave cable is faulty, if yes replace it.
		6.2	Check if Slave is not selected in Master-Slave selection menu.
7	There is no Fuse visible	7.1	There is no user replaceable fuse in the power supply. Only inside power supply unit there are fuses to protect the fault conditions. In case of these gets open, only Scientific qualified or authorized trained personal should replace the fuse.
8	Others	8.1	If fault still persist, the power supply unit should be sent to Scientific for necessary repairs. Please follow the instructions given in Dispatch procedure for servicing the power supply units on next page, before sending the unit.

## **Chapter 8 Dispatch procedure for service & warrantee**

### **8.1 Dispatch procedure for service**

No user serviceable parts are inside the instrument, should it become necessary to send back the instrument to factory for service, please observe the following procedure :

Before dispatching the instrument please write to us giving full details of the fault noticed.

1. After receipt of your communication, our service department will advise you whether it is necessary to send the instrument back to us for repairs or the adjustment is possible in your premises.
2. Dispatch the instrument (only on the receipt of our advise) securely packed in original packing duly insured and freight paid along with accessories and a copy of the faults details noticed at our Service Center or factory.

### **8.2 Warranty conditions**

Scientific warrants all its Instruments to be free from defects in material and workmanship when used under normal operating conditions in accordance with the instructions given in the manual for a period of 12 (Twelve) months from date of purchase from Scientific or its authorized dealers. The service during the warranty period will be rendered on return to factory / service center basis.

1. Its obligation under this warranty is limited to repairing or replacing at its own discretion. This warranty shall not apply to any defect, failure or damage caused by accident, negligence, mis-application, alteration or attempt to repair, service or modify in any way.
2. This warranty does not include display, fuses, batteries or accessories. This warranty is only valid with the original purchaser who must have properly registered the product within 15 days from date of purchase. No other warranty is expressed or implied.
3. When it becomes necessary to return the instrument to our Factory facility, kindly pack it carefully in the original carton or equivalent and ship it duly insured, transportation charges prepaid.
4. Your Scientific instrument is a complex electronic device and deserves the best service available by technicians thoroughly familiar with its service and calibration procedures.