



# SM3300-series

- **SM 18-220**
- **SM 66-AR-110**
- **SM 100-AR-75**
- **SM 330-AR-22**
- **SM 660-AR-11**

## Firmware Update

It is strongly recommended, first to perform a firmware update before further operation.

See chapter Quick Start, paragraph 2.

## PRODUCT MANUAL

### Firmware version P0155

Contents:

- 1 - Datasheet
- 2 - Safety Instructions
- 3 - Quick Start
- 4 - General
- 5 - Installation
- 6 - Front Menu Operation
- 7 - Remote Programming
- 8 - Trouble Shooting
- 9 - Maintenance & Calibration
- 10 - EU Declaration of Conformity

## 2 SAFETY INSTRUCTIONS SM3300

### 1 Caution

The following safety precautions must be observed during all phases of operation, service and repair of this equipment. Failure to comply with the safety precautions or warnings in this document violates safety standards of design, manufacture and intended use of this equipment and may impair the built-in protections within. Delta Elektronika shall not be liable for user's failure to comply with these requirements.

### 2 Installation Category

The Delta Elektronika power supplies have been evaluated to installation category II (Over voltage category II).

### 3 Grounding of Mains Input

This product is a safety Class 1 unit. To minimize shock hazard, the unit chassis must be connected to the AC Power Supply mains through a three or four conductor power cable for respectively a single or three phase unit, with the ground wire firmly connected to an electrical ground (safety ground) at the power outlet.

For units designed to be hard-wired to supply mains, the protective earth terminal must be connected to the safety electrical ground before another connection is made. Any interruption of the protective ground conductor, or disconnection of the protective earth terminal will cause a potential shock hazard that might cause personal injury.

### 4 Grounding of Power Output

If the output of a unit is specified to deliver maximum 60VDC, and either the negative or positive power output is grounded, the voltage on the power outputs and sense connections can be considered safe.

**Warning:**

When the positive power output can exceed 60VDC in respect to the negative output, additional external measures must be taken to ensure safety isolation of the power outputs and sense connections.

**Warning:**

When the negative power output of the unit can exceed 60VDC / 42.4Vpk in respect to ground, additional external measures must be taken to ensure safety isolation of the power outputs and sense connections.

The standard LAN and Interlock connectors and optional interfaces are at ground level and can be considered safe if the negative power output of the unit does not exceed 1000VDC / 707Vpk in respect to ground.

**Caution 1:** If a low voltage unit has both power outputs floating, or if the output is in series with an external high AC or DC voltage, the negative power output can exceed the safe value in respect to ground as specified in the above warning!

**Caution 2:** Although a high voltage unit is set to a safe voltage below 60VDC, for safety it must always be considered as high voltage unit! Wrong operation, a programming error or an external defect can result in an unsafe high output voltage.

For more information and schematics regards Grounding and Safety, see the special application note "*Safe operation of a power supply*" on the Delta Elektronika website.

### 5 Danger of electrical shock

Touching the contacts of the mains plug or wires directly after disconnecting from the mains can cause an electrical shock. See next paragraph "Connection to the mains supply".

### 6 Connection to mains supply

Either connect to the mains supply permanently or via an industrial type plug, complying with IEC 60309. "Permanently connected equipment" or "Pluggable equipment type B".

### 7 Fuses

Fuses must be changed by authorized Delta Elektronika service personnel only, for continued protection against risk of fire.

### 8 Input Ratings

Do not use an AC Supply which exceeds the input voltage and frequency rating of this unit. The input voltage and frequency rating of the Delta Elektronika power supply series are stated in the accompanying datasheet.

### 9 Live Circuits

Operating personnel must not remove the unit cover. No internal adjustment or component replacement is allowed by non Delta Elektronika qualified personnel. Never replace components with the power cable connected. To avoid injuries, always disconnect power, discharge circuits and remove external voltage sources before touching components.

### 10 Parts Substitutions & Modifications

Parts substitutions and modifications are allowed by authorized Delta Elektronika service personnel only. For repairs or modifications the unit must be returned to a Delta Elektronika service facility.

## 11 Removal of (safety) covers

Safety cover(s) are used to cover potentially hazardous voltages. Observe the following when removing safety cover(s):

- Switch off the unit.
- Disconnect the unit from the mains supply.
- Wait for 3 minutes to allow internal capacitors to discharge.
- Unscrew the screws and remove the cover(s).
- Always place the cover(s) back before connecting the unit to the mains supply again.

## 12 Environmental Conditions

The Delta Elektronika power supplies safety approval applies to the following operating conditions:

- Indoor use
- Ambient temperature : -20 to 50 °C
- Maximum relative humidity : 95%, non condensing, up to 40 °C  
: 75%, non condensing, up to 50 °C
- Altitude : up to 2000 m
- Pollution degree : 2



*Caution risk of electrical Shock*



*Instruction manual symbol. The unit will be marked with this symbol when it is necessary for the user to refer to the instruction manual*



*Protective ground conductor terminal*



*Off (supply)*



*On (supply)*

## 13 Canada



This product has been tested to the requirements of CAN/CSA-C22.2 No. 61010-1, second edition, including Amendment 1, or a later version of the same standard incorporating the same level of testing requirements

## 14 cTUVus

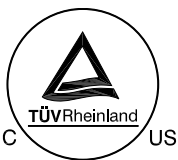

## WEEE (Waste Electrical & Electronic Equipment)

### 1 Correct Disposal of this Product

Applicable in the European Union.



This marking shown on the product, its packing or its literature indicates that it should not be disposed with other wastes at the end of its working life, but should be collected separately to recycle it responsibly to promote the sustainable reuse of material resources.

## 3 QUICK START GUIDE - SM3300

### 1 Connecting the unit

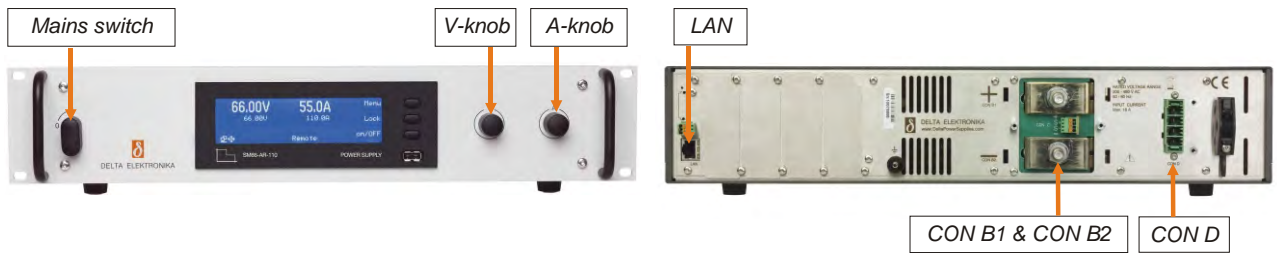

fig. 3 - 1

**Warning!** Never make connections to the Power Inputs and Outputs or the Sense Connector when the unit is connected to the mains supply or power outlet! Safety covers are used to cover these in- and outputs.

Carefully read the chapter "Safety Instructions" in this manual before connecting or operating the unit!

**Warning!** Some components inside the power supply are at AC voltage even when the On/Off switch is in the off position. Therefore a readily accessible, appropriately rated, disconnect device shall be incorporated external to the equipment. The power supply shall be connected to the mains supply via a protection device with a rating of maximum 16A. For example a circuit breaker or fuses etc.

#### AC POWER TERMINALS (AC-MAINS)

- This connector is located at the rear side, marked as CON D.
- Use a cable with a diameter of  $2.5 \text{ mm}^2$  for each wire and a sufficient voltage rating for the AC input voltage of the unit.
- Use the included 4-pole header with the markings L1, L2, L3, PE for connecting the wire to the unit (see fig. 3 - 2/3).
- The mounting torque for the header terminals is 0.6 Nm.
- Always connect the PE terminal to the Protective Earth, no neutral connection is required on a 3 phase grid.
- The unit can operate both on a single phase and a 3 phase grid, with a rated voltage of 200...480VAC.
- For a single phase grid, connect Null and Line between L1 and L2, see fig. 3 - 2.
- After installation, connect the pull relief and add the safety cover over the AC terminals.

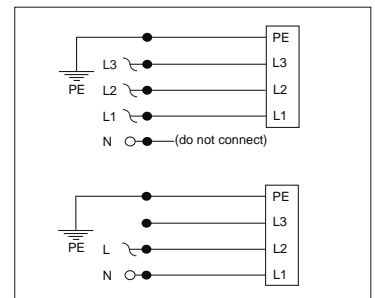

fig 3 - 2  
3 phase & single phase  
input connections.

#### DC POWER TERMINALS

- These terminals are located at the rear side, marked as CON B1 (PLUS) and B2 (MINUS).
- Use cables with a sufficient voltage rating for the maximum output voltage of the unit. The cable diameter depends on the type of unit, see table 3.1. For all units the terminals are bolts size M8 and require a mounting torque of 20Nm.
- Use low resistive connections between the power supply and the load:
  - Mount the cable lugs directly on the DC terminals followed by a washer, a split washer and a nut. Always in this order!
  - Never place washers between the lugs and the strips - this can result in excessive heat!
  - Only use nuts and washers supplied with the unit.
- The DC power terminals are floating in relation to Protective Earth.
- After installation mount the safety cover over the DC power terminals.

Unit	DC-cables [mm <sup>2</sup> ]
SM18-220	70
SM66-AR-110	35
SM100-AR-75	25
SM330-AR-22	4
SM660-AR-11	2.5

table 3 - 1  
Recommended  
cable diameters

#### LAN-CONNECTOR

- Insert a standard RJ45 network cable to the LAN-connector at the rear side, see fig. 3 - 1 and make connection to a Local Area Network (LAN) to perform a firmware update and use the units' web browser, see chapter 2.
- The LAN-connector is at Protective Earth level.

#### LOAD SENSING, INTERLOCK, USB, INTERFACES, SERIES-PARALLEL, MASTER/SLAVE

- Refer to user manual for connecting and using these features and options.

## 2 Operating the unit

### FIRMWARE UPDATE

- Switch the unit on by rotating the mains switch on the front panel clockwise.
  - In the unit menu, check the firmware revision via Menu > System > info > Unit > Version.
  - On a computer, check at [www.DeltaPowerSupplies.com](http://www.DeltaPowerSupplies.com) if there is new firmware available via: *Products > SM3300 > Downloads.*
  - If newer, download the firmware package to the computer and connected this to the same LAN as the unit.
  - In the unit menu, check the IP-address via Menu > Interfaces > LAN > Address\*.
  - On the computer, open the SM3300 web interface using an internet browser by entering the IP-address of the unit in the address bar of the browser.
  - In the web interface, go to *Administration > Firmware.*
  - Select "Choose File" and browse to the downloaded package, enter password\* and "Start Update".
- \*Notes:** - the IP-address can change with DHCP enabled (for example after a power cycle).  
 - the default password is DEPOWER.

### FIRST OPERATION

- The first line in the front display indicates the **actual output voltage and current**. The second line shows the settings of the controls.
- Check the text 'front' is indicated - this means the unit is in **local-operation** and can be controlled by the V-knob and A-knob at the front panel.
- **Switch the output on** by pressing the on/OFF button.
- **Turn the V- and A-knob** a half turn clockwise. Depending on the load, a voltage should now be present on the output and a current will run through the load.
- Depending on the load and settings, the unit will be either in **constant voltage or constant current mode**, respectively CV- or CC-mode.
- Respectively the indication 'CV' will appear on the first line, next to the actual voltage value. The indication 'CC' will appear next to the actual current value.

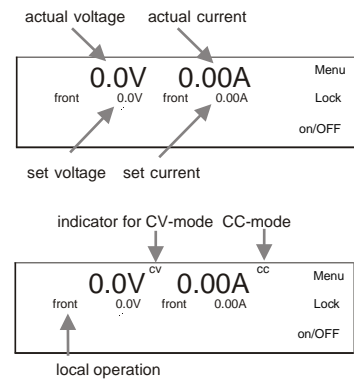

fig. 3 - 3, Start-up settings.

### LIMITATION OF SETTINGS

- By default, the settings for CV and CC Limit are set to the maximum.
- **Change the limit settings** via Menu > Protection > Limits.

### REMOTE PROGRAMMING

- By default a unit is in **local operation**, see fig. 3 - 4.
- In **remote operation** different programming options are available such as 'eth', 'web', 'seq', 'slot1' etc.
- Via the front menu the source can be set to the **required programming input** via: Menu > Configuration > Source.
- When connected to LAN, enter the unit's IP-address in a web browser to open the **web interface**. With this interface all above described parameters plus additional parameters can be set and read.
- For more information, see the chapter Remote Programming of the user manual.

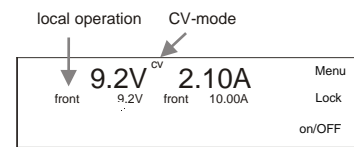

fig. 3 - 4, 19W output power.



fig. 3 - 5, The front console of the web interface for setting of the input and monitoring various parameters.

## 3 Download User Manual

### FULL VERSION

- Check at [www.DeltaPowerSupplies.com](http://www.DeltaPowerSupplies.com) for the full version of the user manual via: *Products > SM3300 > Downloads.*
- It is strongly recommended to regularly check for new versions of the user manual and firmware for additional functionality and improvements.



fig. 3 - 6, Regularly check for new versions of user manual and firmware.

## 4 GENERAL

### 1 OUTPUT

- The SM18-220, SM66-AR-110, SM100-AR-75, SM330-AR-22 and SM660-AR-11 can either be used as a constant voltage source with current limiting or as a constant current source with voltage limiting.
- The change of mode occurs sharply at the crossing of the voltage and current settings. Figure 4 - 1 shows the output ranges.

### 2 AUTO-RANGE

- The SM66-AR-110, the SM100-AR-75, the SM330-AR-22 and the SM660-AR-11 feature an AUTO-RANGING facility where the power supply automatically switches over between two current ranges. This switching, which is unnoticeable for the user, results in a versatile power supply with twice the output voltage range.
- This means that for the SM66-AR-110 the maximum output power is available at both 33V and 66V.
- For SM100-AR-75 this is at both 50V and 100V, for the SM330-AR-22 this is at both 165V and 330V and for the SM660-AR-11 this is at both 330V and 660V.

### 3 MAX OUTPUT POWER

- The standard output range of each of the SM3300 units is chosen in such a way, that the unit can deliver more than 3300W. Most units can deliver around 3600W but this depends strongly on the input voltage and ambient temperature.
- For example the SM18-220 on a three phase 400VAC input voltage can deliver approximately 3700W. Thus at 18V the maximum output current is 205A. When using it on 17V, the maximum current is 220A.
- On 230VAC single phase the power is derated to approximately 3000W, thus delivering maximum 18V / 166A or 13.5V / 220A.
- For the SM18-220 the full range of 18V and 220A (=4000W) cannot be used simultaneously because the input power is limited to 3750W.
- See datasheet for more details.

### 4 OVERLOAD PROTECTION

- The power supply is fully protected against all overload conditions, including short circuit.

### 5 INPUT VOLTAGE

- The power supplies work on a single phase or three phase input voltage and have a wide input voltage range.
- In case of a low input voltage, the AC-Fail status will be high. When operating on a 3 phase input voltage, no neutral connection is required.

### 6 INPUT CURRENT

- The unit has active power factor correction (PFC). The input current will therefore almost be a sine wave. This means that the RMS-value and the harmonic distortion of the input current will be relatively low.
- The peak inrush current is electronically limited. Switching on and off repeatedly will not result in excessive currents.

### 7 INPUT POWER WITH OUTPUT OFF

- The unit consumes very little power when the output is switched off. This makes it possible to leave the input power on when the output is disabled using the Output On/Off function.
- The output can be switched On/Off via a push button on front panel or by remote programming.

SM18-220

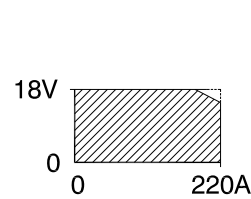

SM66-AR-110

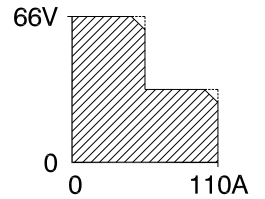

SM100-AR-75

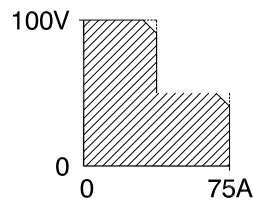

SM330-AR-22

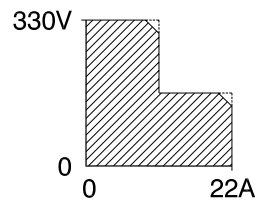

SM660-AR-11

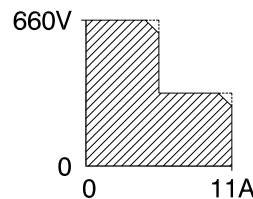

fig. 4 - 1  
Output voltages and currents.  
Every point in the hatched area can be used.

**8 TURN ON DELAY**

- The output voltage is available very quickly after mains switch on. In the datasheet the exact specifications can be found.

**9 INRUSH CURRENT**

- The inrush current is electronically limited. Repeatedly switching on and off does not change the maximum peak current. Switching on and off at a fast rate can overheat the inrush current limiter. With the result that the unit does not start anymore. After cooling down (mains switched off) it will be OK again.

**10 EFFICIENCY**

- The efficiency is very high and constant over a wide output current range. High efficiency means low power loss and low heat generation.

**11 RIPPLE & NOISE**

- The output ripple is very low with almost no spikes. At low temperatures like  $-20^{\circ}\text{C}$  the ripple increases. By using high quality electrolytic capacitors the increase is relatively low.

**12 RFI SUPPRESSION**

- Both the input and output have RFI filters, resulting in very low conducted RFI to the line and load. Due to the output filter the output voltage is very clean, having almost no spikes.

**13 ROTARY ENCODERS**

- Digital encoders for CV and CC setting with a very long life time and intelligent functions (e.g. Keylock, variable pitch).
- The encoders can also be used for scrolling through the front menu.

**14 VOLTAGE AND CURRENT LIMIT**

- The Voltage Limit will protect your circuit from unwanted high voltages. A high output voltage could be caused by accidental interruption of leads, accidentally turning up the voltage setting, a programming error or a defect in the power supply. The Voltage Limit circuit uses a separate voltage divider connected directly to the output terminals.
- The Current Limit protects your circuit from unwanted high currents.
- The Voltage and Current Limits maintain the output to a safe preset value. They do not trip, so no resetting is needed after a fault.

**15 HOLD - UP TIME**

- The hold - up time depends on the load and the output voltage. A lighter load or a lower output voltage results in a longer hold - up time (see fig. 4 - 3).

**16 REMOTE SENSING**

- The voltage at the load can be kept constant by remote sensing. This feature should only be used when the load voltage is not allowed to vary a few millivolts.
- In order to compensate for the voltage drop across the load leads, the unit will have to supply a higher voltage (see fig. 4 - 4). The sense leads are protected against accidental interruption.

**17 SERIES OPERATION**

- The power supplies can be connected in series without special precautions. For the maximum allowed series voltage, see chapter 'Installation'.
- For easier control, the optional Master/Slave interface is



fig. 4 - 2

Digital rotary encoders for voltage and current setting and for menu operation.

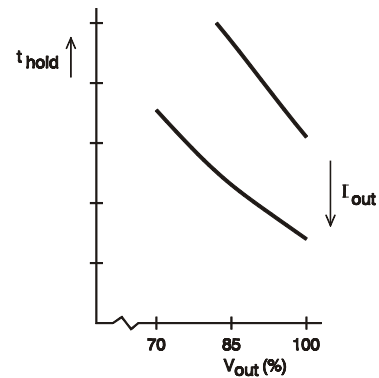

fig. 4 - 3

Hold-up time vs  $V_{out}$  with  $I_{out}$  as a parameter

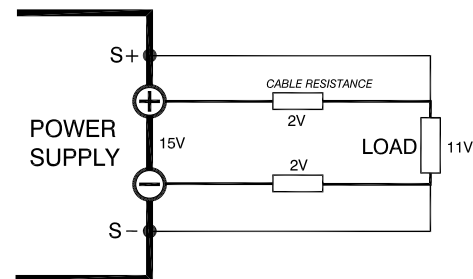

fig. 4 - 4

Remote sensing, voltage drop in load leads subtracts from max. output

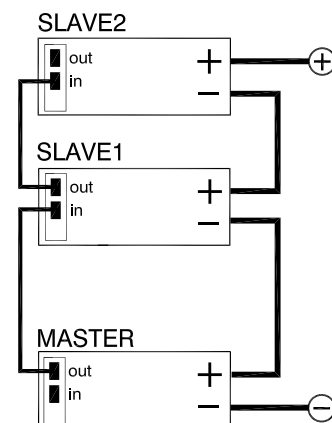

fig. 4 - 5

Master / Slave series operation

recommended (see fig. 4- 5). By using the Master/Slave series interface, a dual tracking power supply can be made with one unit as master and one or more units as slave.

- For series operation in combination with Power Sink option, all units must have a Power Sink built inside otherwise no power can be absorbed.

## 18 PARALLEL OPERATION

- The power supplies can be connected in parallel without special precautions and limitations.
- For easier control, the optional Master/Slave interface is recommended (see fig. 4- 5 and fig. 4 - 6). By using the Master/Slave series interface, a dual tracking power supply can be made with one unit as master and one or more units as slave.
- For parallel operation in combination with Power Sink option, only one unit can have a Power Sink.

## 19 INTERLOCK

- The Interlock connector at the rear panel has an output and an input which have to be connected together to turn on the power output of the unit.
- As soon as the link between the 2 inputs of the Interlock connector is disrupted, the output of the unit shuts down.
- It can be used in combination with a cabinet door contact (safety precaution) or as an emergency brake to stop a motor which is powered by the unit. Once the inputs are connected again, the output will be on.

## 20 WEB INTERFACE & ETHERNET PROGRAMMING

- The web interface and Ethernet programming are standard available on all units via LAN connector at the rear side.
- The web interface can be used to view and change the settings for CV, CC, Output On/Off, configure optional interfaces or power sink, to upload new firmware and configure the unit similar as with the front display menu.
- With the build-in Ethernet interface it is possible to program the CV/CC-settings, to read the CV/CC-monitors and the status signals.

## 21 SEQUENCER PROGRAMMING

- Possibility to use the unit in stand-alone automation or use as an arbitrary waveform generator and create loops, ramps etc.
- The sequencer can be controlled via the web interface and via Ethernet programming.

## 22 OPTIONAL INTERFACES

- Up to a number of 4 different interfaces can be plugged in the sockets at the rear side of the unit.
- All interfaces can easily be plugged in afterwards at the customer site.
- The following types are available:
  - Isolated analog programming & monitoring, logic status outputs.
  - Serial, USB and differential programming.
  - Digital User I/O for programming.
  - Floating Contacts, floating Interlock and floating Enable.
  - Simulation interface for simulation of a photovoltaic curve and other simulation modes.
  - Master/Slave controller.

## 23 PROGRAMMING SPEED

- The specified rise and fall times are measured with a step waveform at the Ethernet programming input.
- Programming from a low to a high output voltage is nearly load independent.
- Programming down to a low voltage takes more time on lighter

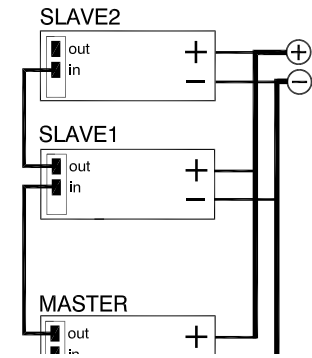

fig. 4 - 6  
Master / Slave parallel operation



fig. 4 - 7  
Different interface modules can be plugged in.



loads. This is caused by the output capacitors, which can only be discharged by the load because the power supply cannot sink current.

- With the Power Sink option, also the programming down speed is nearly load independent.

## 24 OPTIONAL HIGH SPEED PROGRAMMING

- With optional high speed programming, the rise and fall time is 5 to 25 times faster.
- This option must be build in at the factory and cannot be build in afterwards.
- Note that the output ripple is higher.

## 25 OPTIONAL POWER SINK

- With optional power sink, the output voltage setting is maintained when there is power fed back into the unit.
- Ideal for fast discharge of the output at no-load conditions.
- For series operation in combination with Power Sink option, all units must have a Power Sink built inside otherwise no power can be absorbed.
- For parallel operation in combination with Power Sink option, only one unit can have a Power Sink.
- Configuration can be done via the web interface.
- This option must be build in at the factory and cannot be build in afterwards.

## 26 COOLING

- A low noise blower cools the unit. The speed of the fan depends on the temperature of the internal heatsink. Normally, at 50 °C ambient and full load the fan will not work at full speed.
- A special feature is that the fan blows through a tunnel where the heatsink is situated, the delicate control circuitry is separated and will not be in the airflow path (see fig. 4 - 8).
- Because the air enters at the left and exits at the right side, it is possible to stack the power supplies, no distance between the units is required.

## 27 OPERATING TEMP

- At full power, the operating temperature range is -20 to +50 °C. From 50 to 60 °C the output current has to be derated linearly to 75% at 60 °C (see fig. 4 - 9). These temperatures hold for normal use, i.e. the ventilation openings on the left and right side must be free.

## 28 THERMAL PROTECTION

- A thermal protection circuit shuts down the output in case of insufficient cooling. The display will show a thermometer symbol and the OT-status will be active. After cooling down, the unit will start working again.

## 29 FIRMWARE UPGRADING

- **Warning!** never update with the serial or simulation interface(s) inside a unit. First remove the interface, do the upgrade and then place the interface back in position.
- Regularly check for firmware updates at the Delta Elektronika website. If there is a new update available, the unit can updated via the standard web interface.
- This document is based on P0155.

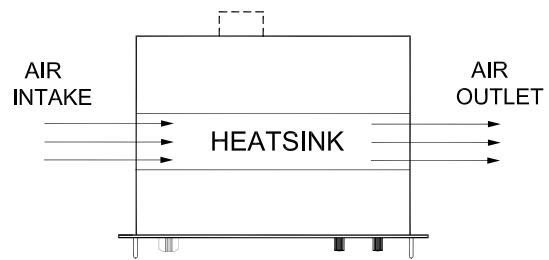

fig. 4 - 8

*The fan blows through the tunnel where the heatsink is situated*

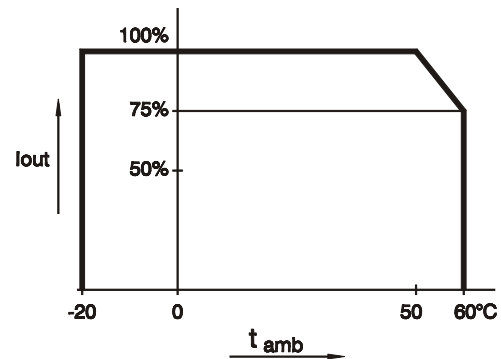

fig. 4 - 9

*Operating temperature ranges*

## 5 INSTALLATION

**Warning!** carefully read the chapter "Safety Instructions" in this manual before connecting or operating the unit!

### 1 HUMIDITY & CONDENSATION

- During normal operation, humidity will not harm the power supply, provided the air is not aggressive. The heat normally produced in the power supply will keep it dry.
- Avoid condensation inside the power supply, break-down could be the result. Condensation can occur during a period the power supply has been switched off (or operating at no load) and the ambient temperature is increasing. Always allow the power supply to dry before switching it on again.

### 2 TEMPERATURE & COOLING

- The storage temperature range is  $-40$  to  $+85$  °C.
- The operating temperature range at full load is  $-20$  to  $+50$  °C. But this temperature range only holds when the air-intake and air-outlet are unobstructed and the temperature of the air-intake is not higher than  $+50$  °C.
- When the power supply is mounted in a cabinet, please note that the temperature of the air-intake should be kept low and avoid a short circuit in the airflow i.e. the hot air leaving the air-outlet entering the air-intake again.
- Please note: a lower temperature extends the life of the power supply.

### 3 19" RACK MOUNTING

- On both sides in the rack, mount a proper support slide that can hold the weight of the unit. It is advised to use a separate slide for each unit.
- After placing the unit on the slide, add all 4 screws to mount the front panel of the power supply to the vertical rack posts. Use proper screws intended for keeping equipment of this weight in position.
- Assuming the rack is calculated for the weight, stacking of the units is allowed without limitations. See previous paragraph for cooling instructions.

### 4 CONNECTING THE UNIT

**Warning!** Never make connections to the Power Input, the Power Output or the Sense Connector when the unit is connected to the mains supply!

Safety covers are used to cover these in- and outputs. Observe the following when removing a safety cover:

- Switch off the unit.
- Disconnect the unit from the mains supply.
- Wait for 3 minutes to allow internal capacitors to discharge.
- Unscrew the screws and remove the safety cover.
- Place the safety cover before connecting the unit to the mains supply again.

**Warning!** Some components inside the power supply are at AC voltage even when the On/Off switch is in the off position. Therefore a readily accessible, appropriately rated, disconnect device shall be incorporated external to the equipment.

The power supply shall be connected to the main supply via a protection device with a rating of maximum 16A. For example a circuit breaker or fuses etc.

#### AC-MAINS / POWER INPUT

- This connector is located at the rear side, marked as CON D.
- Use a cable with a diameter of  $2.5\text{mm}^2$  for each wire. Use a cable with a sufficient voltage rating for the input voltage of the unit.
- Use the included 4-pole header with the markings L1, L2, L3, PE for connecting the wire to the unit. The mounting torque for the header terminals is 0.6Nm.
- Always connect the PE terminal to the Protective Earth.

Unit	Output cables [mm <sup>2</sup> ]	Bolts	Torque [Nm]
SM18-220	70	M8	20
SM66-AR-110	35	M8	20
SM100-AR-75	25	M8	20
SM330-AR-22	4	M8	20
SM660-AR-11	2.5	M8	20

table 5 - 1  
Recommended cable diameters and mounting torque

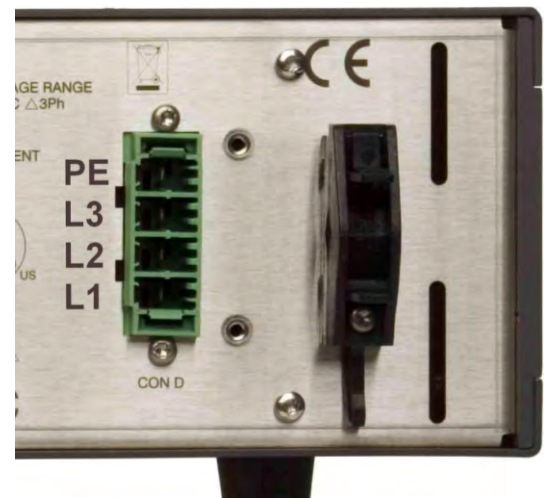

fig. 5 - 2  
Insert the included 4-pole header in CON D for the connection of the input power.

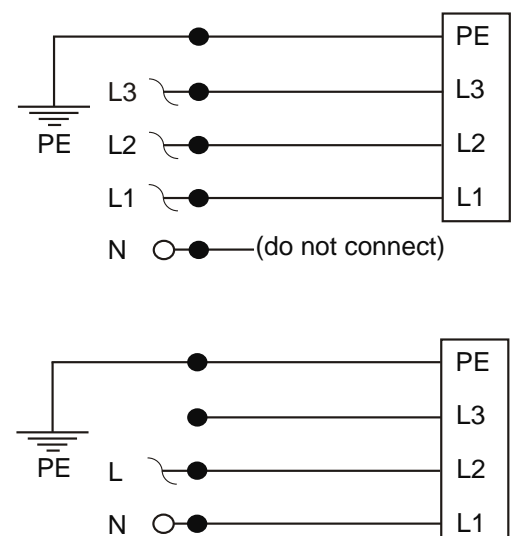

fig. 4 - 2  
3 phase and 1 phase connections

- The unit can operate on a single phase or a 3 phase grid (see fig. 4 - 2), see the chapter 'Specifications' for the minimum and maximum values.
- No neutral connection is required on a 3 phase grid.
- For a single phase grid, connect between L1 and L2.
- After installation, connect the pull relief and add the safety cover over the input.

**POWER OUTPUT**

- These terminals are located at the rear side, marked as CON B1 and CON B2.
- For cable diameters and mounting torque (see table 5 - 1). Use cables with a sufficient voltage rating for the output voltage of the unit.
- With high output current, make sure to use low resistive connections between the power supply and the load:
  - Before connecting the power cables, first remove the remote sensing connector in order not to damage it.
  - Mount the cable lugs directly on the output strips followed by a washer, a split washer and a nut (see fig. 5 - 4). Always in this order!
  - Never place washers between the lugs and the strips because this can result in excessive heat!
  - Only use nuts and washers supplied with the unit.
- Minimize the inductance in the leads by keeping them close to each other or by using a multi-strand cable.
- The power outputs are floating in relation to the Protective Earth.

**REMOTE SENSING**

- This connector is located at the rear side, marked as CON C.
- Use the included 4-pole header for connecting the sense wires to the unit. By pressing the orange clips with a small screwdriver, the wires can be inserted or released.
- When local sensing, check there is a link between + and S+ and between - and S- on the sense header (default).
- For remote sensing, please first read the paragraph 'Remote Sensing' for more details.
- For remote sensing, remove the links between + and S+ and - and S- from the header and connect sense leads to the inputs for S+ and S-.
- Use cables with a diameter of 0.3 ... 0.5mm<sup>2</sup> and with a sufficient voltage rating for the output voltage of the unit.
- The leads are only thin measuring wires but always have to be shielded. In order to prevent interference, it is advisable to twist the leads. See fig. 5 - 6.
- With regards Safety, the sense terminals are at the level of the Power Outputs.
- After installation add the safety cover over the power output.

**LAN-CONNECTOR**

- This connector is located at the rear side, marked as LAN.
- For Ethernet programming or Web Interface control, insert a standard RJ45 cable in the LAN connector at the rear side.
- With regards Safety, the LAN connector is at the level of Protective Earth.

**INTERLOCK CONNECTOR**

- This connector is located at the rear side, marked as CON A.
- Use the included 3-pole header for connecting the interlock wires to the unit. By pressing the orange clips with a small screwdriver, the wires can be inserted or released.
- For more details and specifications about Interlock, please read the paragraph 'Interlock Function' in this chapter.
- When the Interlock function is not used, connect a link between terminal 1 and 3 of the Interlock header (default).
- Use cables with a diameter of 0.3 ... 0.5mm<sup>2</sup> and with a sufficient voltage rating for the voltage of the circuit.
- With regards Safety, the Interlock connector is at the level of Protective Earth.

**FRONT USB-CONNECTOR**

- This connector is located at the front panel, in the lower right corner under the display.
- With firmware package P0155, this connector is still disabled.
- With regards Safety, the Front USB-connector is at the level of Protective Earth.

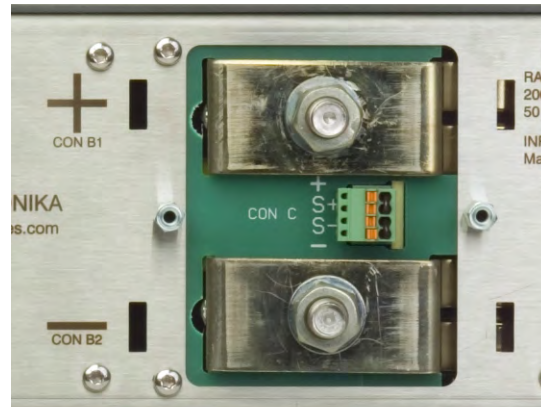

fig. 5 - 4

The two power outputs.  
In between them the remote sensing connector.

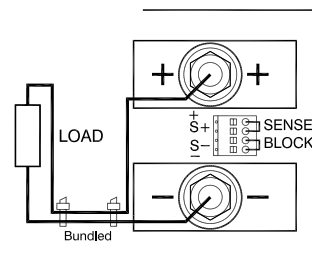

fig. 5 - 5

Local sensing with the power cables bundled close together to minimize inductance.

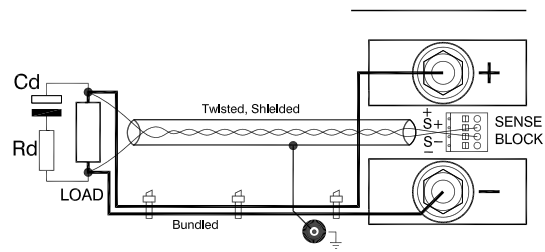

fig. 5 - 6

Remote sensing with shielded twisted wires the power cables bundled close together to minimize inductance

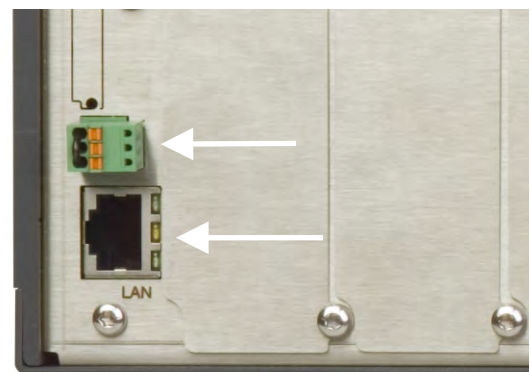

fig. 5 - 3

The location of the LAN-connector (lower) and the Interlock connector (upper) at the rear panel.

- The USB connector is meant for direct connection of flash drives.

## OPTIONAL INTERFACES

- For programming via an optional interface, refer to the interface manual for installation and cable connections.

## 5 INSULATION

- The insulation of the separating components between input and output, such as transformers and opto-couplers, is tested before assembly during 1 minute @ 3750 Vrms (5300VDC).
- The insulation between input and Protective Earth (3500VDC) and between output and PE (1000VDC) is tested after assembly.
- **Note1:** the specified insulation between input and output cannot be tested afterwards on the assembled unit!
- **Note2:** when testing the insulation, take care to charge and discharge the capacitors between input - case and output - case slowly (e.g. in one second). This to prevent high peak currents, which could destroy the power supply. Make sure to discharge the capacitors completely before using it again.

## 6 REMOTE SENSING

- **Warning!** This feature is not recommended for normal use, because damping is critical and wrong connection or routing can lead to instabilities.
- With remote sensing, the voltage on the load can be kept constant. The voltage drop in the load leads will be compensated.
- Max. 2.5 V per load lead can be compensated. Note that the voltage drop in the leads decreases the maximum output voltage rating:  $U_{out} = U_{leads} + U_{load}$ .

In fig. 5 - 9 it can be seen that on a 15 V power supply only 11 V will be available on the load when 2 x 2 V compensation is used.

- To minimize the inductance in the leads of the power output, keep them close to each other. The inductance of the load leads could give a problem with pulsating loads. In this case a large electrolytic capacitor (Cd) in series with a damping resistor (Rd) both in parallel with the load will help (see fig. 5 - 6). Check that the capacitor Cd in combination with the load leads and resistor Rd forms a well damped circuit.
- Since the voltmeter is internally connected to the sensing terminals, it will automatically display the voltage on the load. Note that the voltage measured on the load will be lower than on the output terminals.
- The voltage limit measures the voltage on the output terminals, so the limit setting should be increased by the total voltage drop in the load leads.
- For sensing on a pulsating load, see paragraph 'Special Applications' of this chapter.

## 7 INTERLOCK FUNCTION

- The interlock connector has one output (pin1) and one input (pin3). Pin2 is not used. As soon as the link between pin 1 and 3 is disrupted, the power output of the unit will shut down.
- If the link is open, the interlock symbol is flashing in the display, see fig. 5 - 11 and the interlock status will be active.
- Connecting the terminals will switch the output on again.
- **Warning!** The terminals can only be connected to a floating contact, for example a switch or a relay. Internally the terminals are connected to a logic circuit which cannot be charged or loaded!
- The current through a closed contact is less than 1mA. The voltage over the open contact is 3.3V (typical).
- It is not possible to connect the interlock of multiple SM3300 units in parallel.
- With regards Safety, the Interlock connector is at the level of Protective Earth.
- On optional interface ISOLATED CONTACTS, a floating interlock connector is available. See chapter 6 of this manual.
- The maximum Interlock wiring length is 3 meter.



fig. 5 - 7

The location of the front USB-connector.

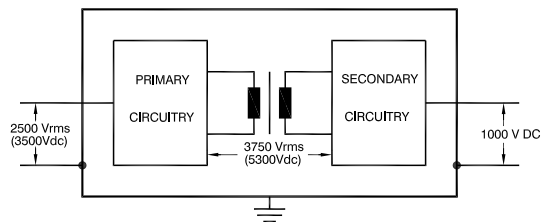

fig. 5 - 8

Insulation test voltages

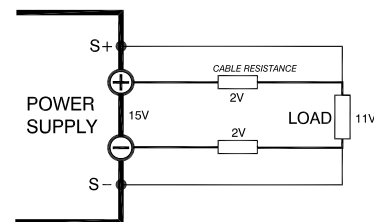

fig. 5 - 9

Remote sensing, voltage drop in load leads subtracts from max. output

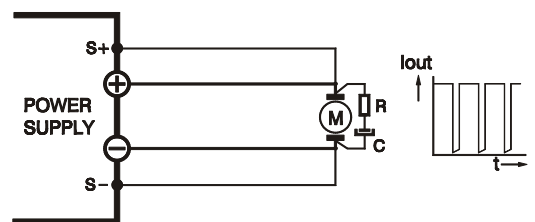

fig. 5 - 10

Remote sensing on a pulsating load



fig. 5 - 11

The Interlock symbol will be visible in the display when the link is interrupted.

### 8 SERIES OPERATION

- The power supplies can be connected in series without special precautions.
- The operational isolation of SM18-220, SM66-AR-110 and SM100-AR-75 allows a total series voltage of 1000V.
- The operational isolation of SM330-AR-22 and SM660-AR-11 allows a total series voltage of respectively 1330V and 1400V.
- **Warning!** The minus power output of the unit is allowed to be maximum 1000VDC higher or lower than the Protective Earth, regardless of the higher allowed series voltage!  
For more details, see Safety Instructions in chapter 2.

### 9 PARALLEL OPERATION

- The power supplies can be connected in parallel without special precautions. Paralleling of the units has no limitations.
- Normal parallel operation of units High Speed Programming units can give problems. Each combination has to be tested first, in combination with the load!

### 10 OPTIONAL MASTER / SLAVE CONTROL

- For easy series or parallel operation the Master / Slave interface is advised.
- Master / Slave parallel operation of High Speed Programming units is not recommended.
- See chapter 6 for more information about the M/S interface.

### 11 OPTIONAL POWER SINK

#### SETTING UP THE POWER SINK

- Settings for disabling/enabling can be made via the web interface, see chapter 6.

#### POWER SINK OVERLOAD (PSOL)

- If the maximum sink power has been reached, the Power Sink will go in overload and the sink current will be limited. In this situation the Sink cannot absorb more power and the output voltage of the supply will rise.
- On the front panel the PSOL icon will be blinking and the status output 'PSOL' will be high.

#### THERMAL OVERLOAD (OT)

- If the Power Sink runs hot, the fan starts blowing to cool it down. Once the situation of thermal overload has been reached, the Power Sink and the output shut down completely until the internal heat sink has cooled down again. In this OverTemp situation the OT-status will be high.

#### SERIES OPERATION

- For series operation in combination with Power Sink option, all units must have a Power Sink built inside otherwise no power can be absorbed.

#### PARALLEL OPERATION

- For parallel operation in combination with Power Sink option, only one unit can have a Power Sink. The output voltage of this unit must be set 0.5% higher than the other units.
- When using Master/Slave parallel operation, always set the unit with the power sink as master.

### 12 SPECIAL APPLICATIONS

#### PULSATING LOAD

- To avoid overheating the output capacitors, the AC component of the load current should be limited (see fig. 5 - 13).
- One method of reducing the AC current through the output capacitor is by using a large external electrolytic capacitor in parallel with the load. Care must be taken so that the capacitor in combination with the lead inductance will not form a series resonant circuit!
- When using remote sensing on a pulsating load (for instance a DC-motor), use a capacitor in series with a resistor over the load (see fig. 5 - 10). Like this the AC-component caused by the pulsing of the load is filtered.
- Note: in case of a pulsating load, the I monitor voltage will not exactly match the output current. This is mainly caused by the current through the output capacitors. Remote sensing will worsen this effect.

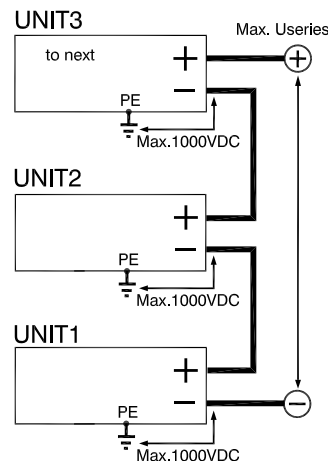

fig. 5 - 12

For series operation the maximum series voltage is between 1000VDC and 1400VDC.  
Never exceed the 1000VDC between the minus power outputs and PE!

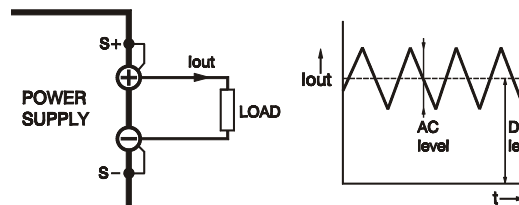

fig. 5 - 13

Pulsating load current

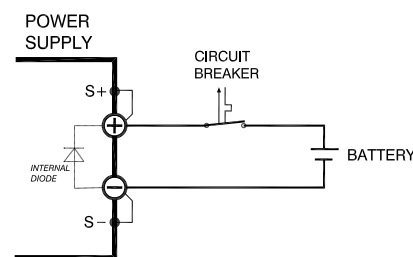

fig. 5 - 14

Charging battery with a circuit breaker in series to protect the internal diode.

**BATTERY CHARGER**

- The CV / CC regulated power supplies are ideal battery chargers. Once the output is set at the correct voltage the battery will charge constantly without overcharging. This can be useful for emergency power systems.
- Protective measures  
Use a Circuit Breaker in series in order to protect the power supply from accidental reverse connection (see fig. 5 - 14). The unit has a reverse diode in parallel with the output, this diode and the wiring cannot withstand the thousands of amperes supplied by a wrongly connected battery.  
The circuit breaker should have a DC voltage rating twice the battery voltage. Use the very fast type (Z), a type meant for protecting semiconductors (see table 5 - 2).

**13 OPERATING THE UNIT**

**FIRST OPERATION**

- Switch the unit ON by rotating the mains switch on the front panel clockwise.
- The first line in the front display does indicate the actual values for the output voltage and output current. See fig. 4 - 15.
- The second row shows the settings of the controls for the voltage and current. If the unit is in local operation, the text 'front' is indicated before the settings values. If the unit is set to remote programming, for example Ethernet programming, the text 'eth' is indicated. See fig. 4 - 15...18.
- The right side of the display shows the texts 'Menu', 'Lock' and 'ON/off'. Press the push buttons right from these texts to operate the following item:

**\* Menu**

This will enter the main menu of the unit. See the next chapter for the different choices and settings.

**\* Lock**

Pressing this button for about 4-5 seconds will lock the rotary encoders and/or the display menu. Pressing this button again for 4-5 seconds, will unlock the encoders and/or the display menu.

This function can be useful to protect the output from accidental shutdown. See next chapter for exact possibilities of the 'Lock' function.

**\* On/Off**

Pressing this button will switch the power output on or off. If the unit is equipped with an optional Power Sink, via the web server it can be chosen to also switch this off, or leave it on.

- Check if the unit is in local operation: the text before the set values on the 2nd row must be 'front'. See fig. 4 - 16.
- Switch on the output by pressing the ON/off button.

**CV- and CC-control**

- Turn both the CV and CC encoder a few turns clockwise. A voltage should now be present on the output.
- Under the values for the actual output voltage and current, the display does always show the settings of the CV- and the CC-encoders. See fig. 4 - 16.
- Depending on the load and the settings, the unit will be either in CV or in CC mode. See fig. 4 - 17. Respectively the indication 'CV' will appear on the first line, next to the actual voltage value. The indication 'CC' will appear next to the actual current value.

**CV- and CC-limit**

- In the default configuration, both the settings for CV- and CC-limit are set to the maximum values.
- To set the limits to a lower value, go to Menu -> Protection -> Limits. Here set both Voltage and Current limits.

**REMOTE PROGRAMMING**

- Before the set values, the selected source is shown, see fig. 4 - 18. For example 'eth', 'web', 'seq', 'slot1' etc.
- For more information, see chapter 6 of this manual.

Suggested circuit breakers for protection power supply			
Model	Type number	Brand	Remarks
SM18-220	HTI102 B 125	GE	2 poles parallel
SM66-AR-110	HTI102 B 100	GE	2 poles parallel extra parallel diode on output needed
SM100-AR-75	HTI101 B 100	GE	No remarks
SM330-AR-22	S281 UC-Z 50 or S282 UC-Z 20	ABB	extra parallel diode on output needed
SM660-AR-11	FHL 3603013	Schneider Electric	2 poles in series extra parallel diodes on output needed

table 5 - 2 Circuit breakers for protection.

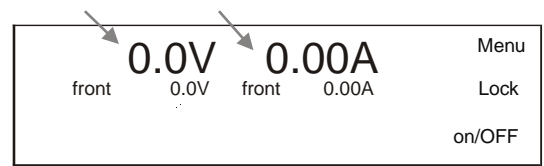

fig. 5 - 15

The first line in the display shows the actual output value for voltage and current.

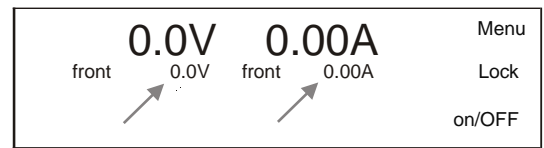

fig. 5 - 16

The second line in the display shows the set value for voltage and current.

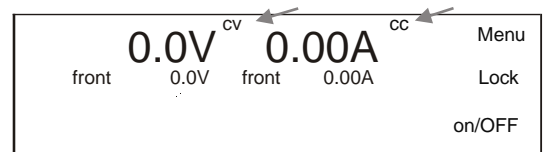

fig. 5 - 17

A unit is either in CV or CC mode, indicated next to the actual values of respectively the output voltage or output current.

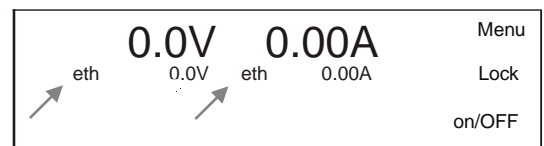

fig. 5 - 18

The programming source appears before the settings. In this example both settings are controlled via Ethernet.

FRONT ICONS

AC FAIL

- This indicator is active if the input voltage is too low / too high.

DC FAIL

- This indicator is active if the output is 5% below or above the set value.

OVER TEMPERATURE

- This indicator is active if the temperature of the heatsink is higher than 90°C. The output will shutdown until the temperature has dropped below 80°C.

LIMITER

- This indicator is active if one of the settings for CV or CC is limited.

SIMULATION

- This indicator is active when the programming source is being compensated by the optional simulation interface.

LAN

- This indicator is active if the unit is connected to a LAN.

INTERLOCK

- This indicator is active if the terminals of the interlock connector have been interrupted.

COMMUNICATION WATCHDOG

- This indicator is active if the communication watchdog timer had expired\*\*.

REMOTE SHUTDOWN

- This indicator is active if the output of the unit is shutdown via the ETH connection, or via an optional interface.

USB

- Not available in firmware package P0155.

POWERSINK OVER LOAD

- This indicator is active if absorbed power of the optional Power Sink is too high.

SMIN / SPLUS BREAK

- Not available in firmware package P0155.

CV- OR CC-MODE

- This indicator will indicate if a unit is operating in CV or CC mode.

CONTROLS LOCKED

- This indicator is active if the rotary encoders on the front panel are locked.

INTERNAL ERROR

- This indicator is active if there is an internal error in the unit, or when an interface is not correctly configured. Verify the "System information" page of the web interface. Or contact support.

INTERFACES

- This indicator is active if there is an interface build inside one of the slots at the rear side.

MASTER or SLAVE

- The standard interface icon is replaced by a Master or a Slave icon if the optional Master Slave interface is configured as a Master or a Slave.

SEQUENCER RUNNING / PAUSE / STOP

- These indicators show the status of the Sequencer.

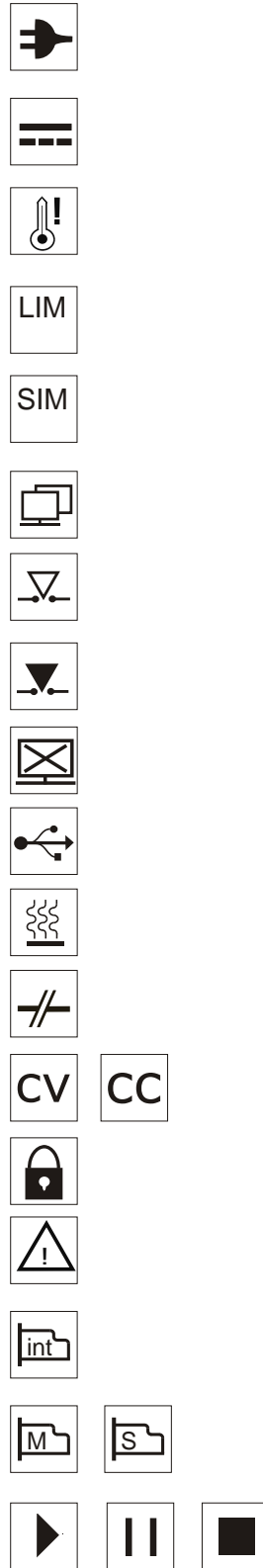
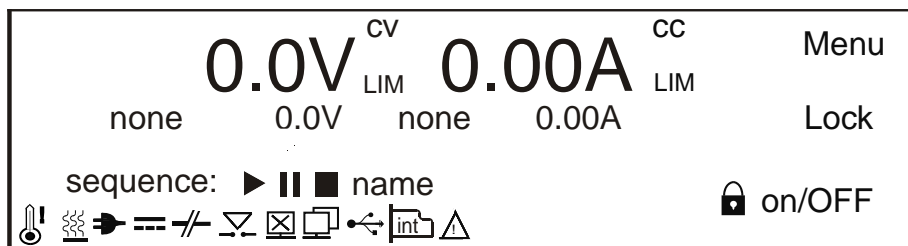

fig. 5 - 19  
Location of  
icons on  
the front  
display.



\*\*Note: 1. If both the interlock and watchdog indicator conditions are true, the symbols will be displayed in an alternating way.

## 6 FRONT MENU OPERATION

### 1 ACCESSING THE MAIN MENU

- After switching on the unit, the right side of the display shows the texts 'Menu', 'Lock' and 'ON/off'. Press the upper push button right from the text 'Menu' to enter the main menu of the unit.
- Operate the left rotary encoder marked 'V' to choose one of the sub menu's. To change or enter the final settings, operate the right rotary encoder marked 'A'.
- By using the upper or middle push buttons, one can go back to the previous menu level (Back) or respectively go deeper in the menu (Select). See below paragraphs for the possibilities.
- In every menu level, it is possible to switch the power output on or off, using the lower push button.

### 2 MENU MAP

- The overview at the right side of this column shows the tree structure of the main menu. Not all items are already implemented in the present firmware package. Regularly check the Delta Elektronika website for new releases. The unit can be updated with the latest package via the web interface.

### 3 MENU SETTINGS

#### SYSTEM INFO

##### UNIT

- VERSION
  - Displays the version of the firmware package.

##### SERIALNR

- Displays serial number

##### PUD

- Displays 'Protected User Data'

##### STATUS

##### TEMPERATURE

- Displays the highest temperature inside the power supply.

##### INPUT

- Displays mains Vac and Iac

#### CONFIGURATION

##### FRONT SETTINGS

##### LCD SETTINGS

##### LIGHT ON

- Select the setting of the display back light level during operation of the rotary encoders or the push buttons.
- A range of 20 - 100% is available.
- The default setting is 50%.

##### LIGHT DIM

- Select the setting of the normal display back light level.
- A range of 0 - 100% is available.
- The default setting is 20%.

##### DIM DELAY

- Select the time after which the display switches back from a high level during encoder or button operation, and the normal back light level.
- A range of 0 - 200 seconds is available (0 = do not dim).
- The default setting is 5 seconds.

##### CONTRAST

- Select the setting of the display contrast.
- A range of 0 - 100% is available.
- The default setting is 60%.

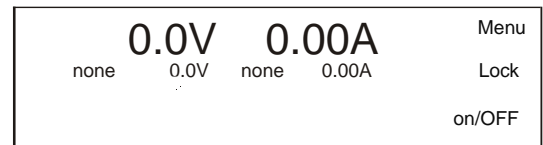

fig. 6 - 1

At the right side of the display, the 3 main menu items can be chosen.

#### Menu tree structure:

##### SYSTEM INFO

##### UNIT

VERSION  
SERIALNR  
PUD

##### STATUS

TEMPERATURE  
INPUT

##### CONFIGURATION

##### FRONT SETTINGS

LCD SETTINGS  
LIGHT ON  
LIGHT DIM  
DIM DELAY  
CONTRAST

##### INDICATORS

SOUNDS  
LANGUAGE

##### POWER-ON STATE

VOLTAGE  
CURRENT  
OUTPUT

##### SOURCE

V-SETTINGS  
I-SETTINGS

##### POWERSINK

STATUS  
SETTINGS

##### MASTER SLAVE

STATUS  
SETTINGS

##### SETUP

RECALL SETUP  
SAVE SETUP

##### PROTECTION

ACCESS SECURITY  
CHANGE CODE  
LOCK OPTIONS  
UNLOCK OPTIONS

##### LIMITS

VOLTAGE LIMIT  
CURRENT LIMIT

##### INTERFACES

##### LAN

ADDRESS  
SUBNETMASK  
GATEWAY  
DHCP  
IP-VERSION  
MAC ADDRESS

##### SLOTS

OVERVIEW



**INDICATORS**

- There are 13 different indicators available: OT, ACF, DCF, PSOL, Interlock, RSD, Internal error, LAN, USB, Sequencer, Interfaces, Vlimit and Ilimit.
  - Select the setting for each indicator separately.
  - Possible settings are NONE, VISUAL, AUDIO and VISUAL&AUDIO.
- SOUNDS**
- Select the sound for each indicator separately.
  - Possible settings are 1xCHANGE, 3xCHANGE, DOWNWARDS and CONTINUOUS BEEP.

**LANGUAGE**

- For firmware package P0155 the language available is 'ENGLISH'.

**POWER-ON STATE****VOLTAGE**

- Select CV-setting of the unit after mains switch on.
- Possible settings are ZERO, FIXED VALUE and RESTORE VALUE.
- Default settings is ZERO.

**CURRENT**

- Select CC-setting of the unit after mains switch on.
- Possible settings are ZERO, FIXED VALUE and RESTORE VALUE.
- Default settings is ZERO.

**OUTPUT**

- Select OUTPUT ON / OFF-setting of the unit after mains switch on.
- Possible settings are DISABLED, ENABLED and RESTORE VALUE.
- Default settings is DISABLED.

**SOURCE****V-SETTINGS**

- Select programming source for the CV-setting.
- Possible settings are NONE, FRONT, ETH and WEB and SLOT1...4.
- Default settings is FRONT.

**I-SETTINGS**

- Select programming source for the CC-setting.
- Possible settings are NONE, FRONT, ETH, WEB and SLOT1...4.
- Default settings is FRONT.

**POWERSINK****STATUS**

- Displays current state
- Displays the temperature of the power sink

**SETTINGS**

- Shows the settings for the optional power sink.
- Settings can be done via the web interface as well.
- Possible settings are Power Sink disabled/enabled, Power Sink on RSD, Interlock and/or Output On/Off.

**MASTER SLAVE****STATUS**

- Displays id number, configuration status and number of units (if device is master).

**SETTINGS**

- Shows the setting for the master slave interface.
- Settings can be done via the web interface as well.
- Possible settings are master slave and number of units in parallel and/or in series.

## SETUP

### RECALL SETUP

- Recall an earlier saved setup of the menu settings, voltage and current settings and limits, network settings.
- Choose Setup1, Setup2 or Setup3.

### SAVE SETUP

- Save the present settings.

## PROTECTION

### ACCESS SECURITY

#### CHANGE CODE

- Select the 4 digit access key.
- Default setting is '0000'.
- In case of a forgotten access key see troubleshooting (chapter 7)

#### LOCK OPTIONS

- Select which functions are blocked with the 'LOCK' function.
- Possible settings are 'Menu', 'Controls' and 'Menu & Controls'.
- Default setting is 'Menu & Controls'.

#### UNLOCK OPTIONS

- Select how to unlock the unit. To make a selection, first the 4 digit access key must be entered.
- Possible settings are 'With Code' and 'Without Code'.
- Default setting is 'Without Code'.

## LIMITS

### VOLTAGE LIMIT

- Select the setting for the Voltage limit.
- Possible settings are 'DISABLED' and 'FIXED VALUE'.
- Default setting is 'DISABLED'.

### CURRENT LIMIT

- Select the setting for the Current limit.
- Possible settings are 'DISABLED' and 'FIXED VALUE'.
- Default setting is 'DISABLED'.

## INTERFACES

### LAN

#### ADDRESS

- Select / View the present IP-address.
- The default setting is 169.254.0.2.

#### SUBNETMASK

- Select / View the present Subnet-mask.
- The default setting is 255.255.0.0.

#### GATEWAY

- Select / View the present Gateway-address.
- The default setting is 169.254.0.1.

#### DHCP

- Select the setting for DHCP.
- Possible settings are 'Enabled' and 'Disabled'.
- Default settings is 'Enabled'.

#### IP-VERSION

- View the IP-version.  
For firmware package P0155, this version is V4.

#### MAC ADDRESS

- Select / View the unique MAC-address.
- The address is in the range of F4:E1:42:xx:xx:xx.

### SLOTS

#### OVERVIEW

- Shows the optional installed interfaces in Slot1, 2, 3 and 4.

## 4 FIRMWARE UPDATING

- Check the version of the firmware in the unit via Menu > System Info > Unit > Version.
  - Go to [www.DeltaPowerSupplies.com](http://www.DeltaPowerSupplies.com) and check if there is new firmware available via *Products* -> *SM3300* -> *Downloads*.
  - Download the new firmware package to the computer.
  - Connect the unit to the above computer via LAN and open the SM3300 web interface using an internet browser.
  - The web interface is found by entering the IP-address of the unit in the address bar of the browser. The IP-address is found via Menu > Interfaces > LAN > Address.
- Note:** when DHCP is enabled the IP-address can change, for example after a power cycle.
- In the web interface, go to *Administration* -> *Firmware*.
  - Select "Choose File" and browse to the downloaded package, enter password and "Start Update". See below figure 5 - 3 for a screen shot of the web interface.
  - Recommended firmware package is P0155.

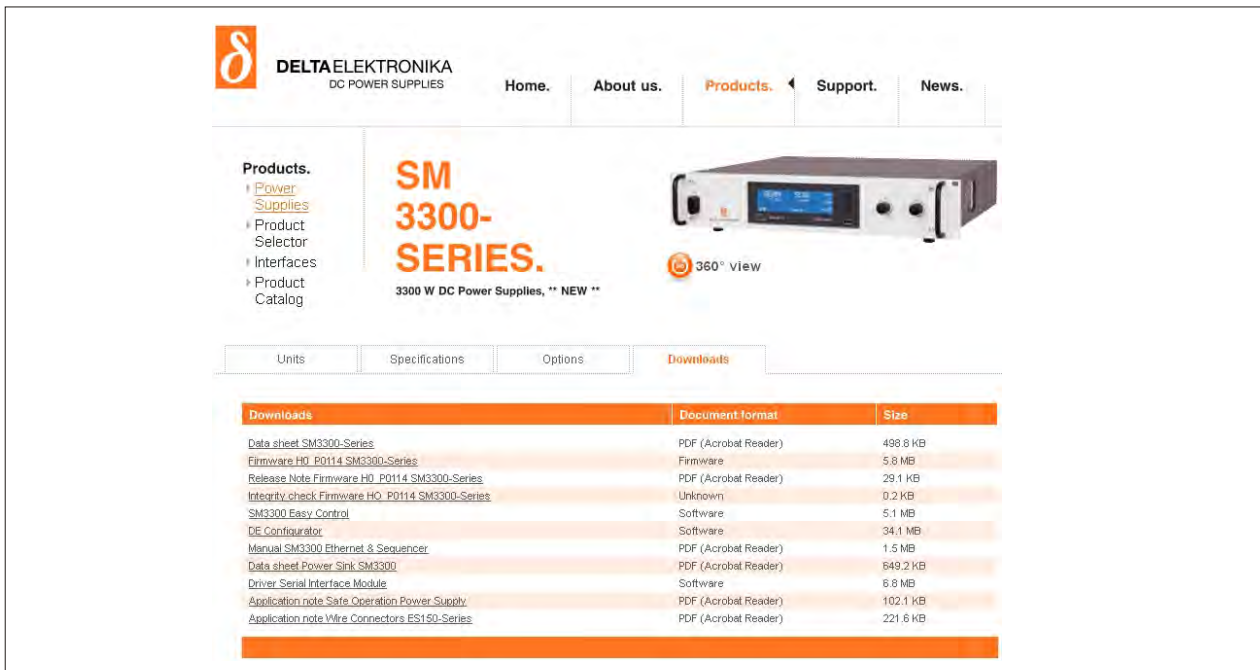

The screenshot shows the DeltaElektronika website for the SM3300-Series. The page features a navigation menu with 'Home', 'About us', 'Products', 'Support', and 'News'. The main content area displays the product name 'SM 3300-SERIES' and a 360° view of the power supply unit. Below this, there is a 'Downloads' section with a table listing various documents and their formats and sizes.

Downloads	Document format	Size
<a href="#">Data sheet SM3300-Series</a>	PDF (Acrobat Reader)	498.8 KB
<a href="#">Firmware H0_P0114 SM3300-Series</a>	Firmware	5.8 MB
<a href="#">Release Note Firmware H0_P0114 SM3300-Series</a>	PDF (Acrobat Reader)	29.1 KB
<a href="#">Integrity check Firmware H0_P0114 SM3300-Series</a>	Unknown	0.2 KB
<a href="#">SM3300 Easy Control</a>	Software	5.1 MB
<a href="#">DE Configurator</a>	Software	34.1 MB
<a href="#">Manual SM3300 Ethernet &amp; Sequencer</a>	PDF (Acrobat Reader)	1.5 MB
<a href="#">Data sheet Power Sink SM3300</a>	PDF (Acrobat Reader)	649.2 KB
<a href="#">Driver Serial Interface Module</a>	Software	6.8 MB
<a href="#">Application note Safe Operation Power Supply</a>	PDF (Acrobat Reader)	102.1 KB
<a href="#">Application note Wire Connectors ES150-Series</a>	PDF (Acrobat Reader)	221.6 KB

fig. 6 - 2 Download a firmware update via [www.DeltaPowerSupplies.com](http://www.DeltaPowerSupplies.com).

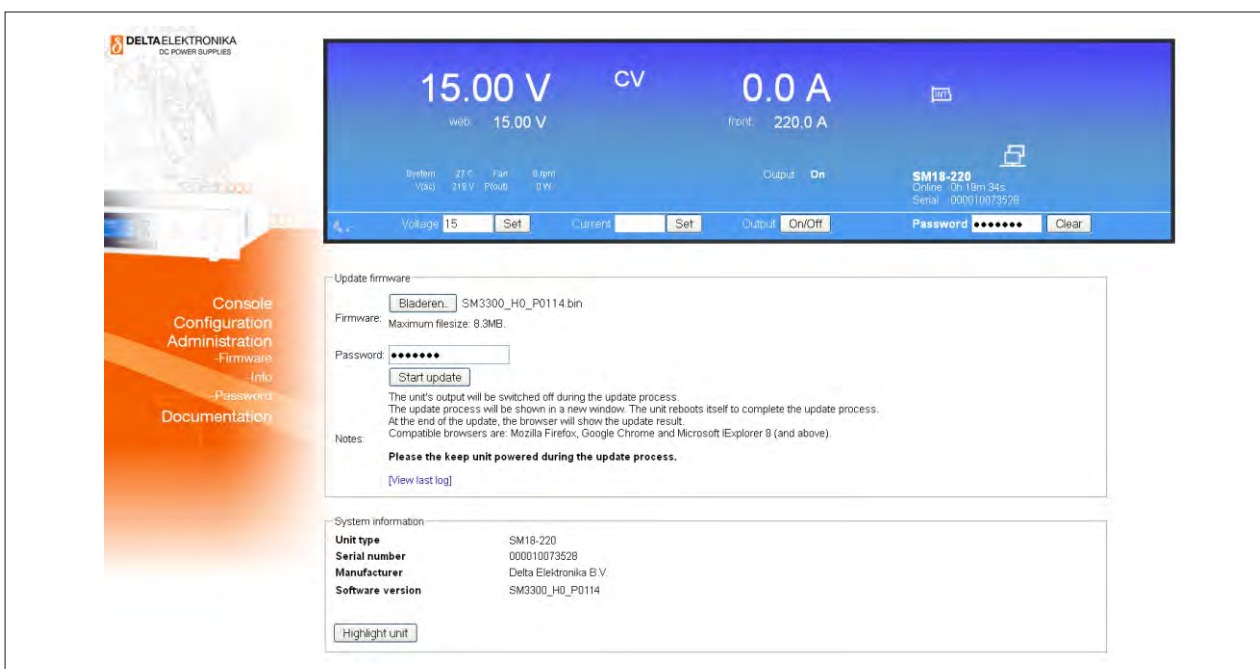

The screenshot shows the SM3300 web interface. The top section displays the current output voltage (15.00 V) and current (0.0 A). Below this, there is a 'Update firmware' section with a file selection field containing 'Bladeren... SM3300\_H0\_P0114 bin', a password field, and a 'Start update' button. A note indicates that the unit's output will be switched off during the update process. At the bottom, there is a 'System information' section showing details for unit SM18-220, including its serial number, manufacturer (Delta Elektronika B.V.), and software version (SM3300\_H0\_P0114).

fig. 6 - 3 Via the web interface the downloaded firmware package can be uploaded to the unit.

## 7 REMOTE PROGRAMMING

### 1 SOURCE SETTINGS

- Via the front menu, the source can be set to the required programming input via: Menu -> Configuration -> Source.
- The possible settings for Vsettings and Isettings are: front encoders, ethernet, web interface, sequencer or an optional interface in rear slot1, 2, 3 and/or 4.
- It is possible to have different sources for the V- and Isettings for example Vsettings via 'web' and Isettings via 'front'.

### 2 WEB INTERFACE

- It is advised to use the web browsers Mozilla Firefox, Google Chrome or MS Internet Explorer 8 or newer.
- The web interface is available 40 seconds after start up of the unit.
- Set the programming source for voltage and/or current to 'web' via the front menu.
- The below menu items are available in the web interface:

#### CONSOLE

##### FRONTPANEL

- Possible settings via the console:
  - voltage and current
  - output On/Off
- Possible monitoring via the console:
  - actual and set values of voltage and current
  - output setting (on/off)
  - status icons, for example DC-fail
  - type of unit and serial number
  - online time of the unit
  - system temperature and fan speed
  - input voltage
  - output power
- See fig. 6 - 1 for the console lay-out.



fig. 7 - 1 Front console for setting of the output and monitoring various parameters.

##### SEQUENCER

- Possible to select sequences from the unit memory.
- Running, Pausing and Stopping of sequences.
- Trigger sequence
- Running in Single Step mode.
- See fig 6 - 2 for the console lay-out.



fig. 7 - 2 Sequencer console for selecting and controlling sequences.

#### CONFIGURATION

##### GENERAL

###### FRONTPANEL

- Front user interface language.
- Front unlock key protected (Enabling will lock Frontpanel).
- Backlight intensity when active.
- Backlight intensity when no user interaction.
- Timeout for backlight dimmer.
- LCD contrast.

###### DEFAULTS

- Default voltage setting after power cycle.
- Default voltage setting after power cycle (when set to fixed).
- Default current setting after power cycle.
- Default current setting after power cycle (when set to fixed).
- Default output state after power cycle.

###### SOURCES

- Set the program source for voltage control.
- Set the program source for current control.

###### POWER SINK

- Enable / disable Power Sink.
- Enable / disable Power Sink when Remote ShutDown

status is high.

- Enable / disable Power Sink when Interlock status is high.
- Enable / disable Power Sink when the Output is Off.

#### NETWORK

- DHCP enabled / disabled.
- IP Version.
- Network IP address.
- Network Subnet mask.
- Network Gateway address.
- Network interface MAC address.

#### INTERFACES (Slot1, 2, 3 and 4)

##### ISOLATED ANALOG

- Voltage levels on analog programming and monitoring for output voltage and current.
- Level of Status signals ACF, DCF, PSOL, LIMIT, RSD, OT and CC.

##### SERIAL & USB

- Select BUS-type: USB, Differential, RS232.
- Device channel nr.
- Baudrate, Databits, Stopbits, Parity bits.
- Slewrate, Termination, Simplex/Duplex.

##### DIGITAL I/O

- Level of digital inputs A...H (High / Low).
- Level of digital outputs A...H (High / Low).

##### ISOLATED CONTACTS

- Status of the relay contact 1...4 (On / Off).
- Level of the Interlock input (High / Low).
- Level of the Enable input (High / Low).

#### SEQUENCES

- Upload sequences into the units' volatile memory.
- Synchronize memory to copy sequences from the volatile to the non-volatile memory.  
After switching off the unit, the sequences are saved.
- Monitor and make settings:
  - View sequencer name
  - View if it is loaded as active sequencer
  - View if it has been build
  - Mark for Non-Volatile
  - Set start/stop conditions
  - Set if to restore or retain output state and values after it is terminated
  - Mark for deletion
- See paragraph 4 of this chapter for more information about sequencer programming.

#### ADMINISTRATION

##### FIRMWARE

- Here the new firmware package can be uploaded.

##### INFO

- System information
  - Unit
  - Serial number
  - Manufacturer
  - Software version
  - Custom mode
  - Internal error
- Highlight button
  - Display on front will blink.
  - Buzzer on front is on.

##### PASSWORD

- Change the password to block the unit.
- The default password is "depower".
- Passwords are not case sensitive
- In case of a forgotten password see trouble shooting.(chapter7)

## DOCUMENTATION

- Unit documentation in PDF-format available:
  - Safety instructions.
  - Unit operation and installation manual.
  - Interfaces operation and installation manual.
  - Ethernet & Sequencer programming manual.

## 3 ETHERNET

- The ETH interface is available 40 seconds after start up of the unit.
- Connect the unit to the network via the LAN-connector at the rear side, see fig 6 - 3.
- Download the programming manual for Ethernet & Sequencer via the web interface or via [www.DeltaPowerSupplies.com](http://www.DeltaPowerSupplies.com).
- Set the programming source for voltage and/or current to 'eth' via the front menu or the web interface.

## 4 SEQUENCER

- Download the programming manual for Ethernet & Sequencer via the web interface or via [www.DeltaPowerSupplies.com](http://www.DeltaPowerSupplies.com).
- Build a sequence using a basic text editor, for example Notepad. Save as "filename.seq". See fig 6 - 4 as example.
- Upload the sequence to the unit via the web interface or via Eth programming commands.
- Set the programming source for voltage and/or current to 'seq' via the front menu, the web interface or Eth commands.
- Start/Stop the sequence via the web interface, Eth commands or a hardware trigger via the Digital I/O interface.
- **Note:** copy the uploaded sequences into the non-volatile memory before switching off the unit. Standard they are uploaded in the volatile memory and are lost after switching off the mains.

## 5 OPTIONAL INTERFACES

- Set the programming source for voltage and/or current to 'slot1...4' via the front menu, the web interface or Eth commands.
- The following interfaces can be plugged in the slots at the rear panel of the unit. There is room to insert a total of 4 different interfaces.

### ISOLATED ANALOG PROGRAMMING

- With this interface it is possible to program the CV- and CC-settings using a 0 - 5V or 0 - 10V voltage source.
- The CV- and CC-monitor signals can be measured with a volt meter (0 - 5V or 0.10V). Also available are the 5V logic status signals, Remote ShutDown (RSD = 5V), an auxiliary voltage (+12V) and a reference of 5.1V.
- Because the interface is isolated from the power output, earth loops between the programming source and the power supply are prevented.
- All connections are pin compatible with other Delta Elektronika power supplies such as ES150, SM800, SM1500, SM6000 etc.
- **Note1:** analog interface can NOT be inserted in slot1.
- **Note2:** maximum 1 analog interface possible per unit.
- See datasheet and manual of the INT MOD ANA for more information.

### SERIAL & USB PROGRAMMING

- The protocols RS232, RS422, RS485 and USB (Virtual COM) are supported by this interface.
- With this interface it is possible to program the CV- and CC-settings, to read the CV- and CC-monitor values and the internal status signals.
- See datasheet and manual of the INT MOD SER for more information.



fig. 7 - 3

The location of the LAN-connector and the available interface slots at the rear panel.

```
sequence1.seq - Notepad
File Edit Format View Help
1 sc=10
2 inc sv,0.1
3 w=0.01
4 cjl sv,15,2
5 #j=10
6 cjne #j,0,6
label1:
7 dec sv,0.1
8 w=0.01
9 cjpg sv,0,label1
10 end
```

fig. 7 - 4

Example of a small sequence to ramp up the output to 15V and then back to 0V.

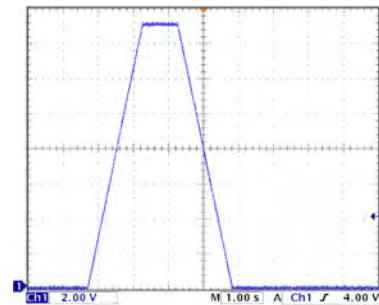

fig. 7 - 5

Output voltage as result of the above example.



fig. 7 - 6

Isolated Analog Programming Module.



fig. 7 - 7

Serial & USB Programming Module.

**DIGITAL I/O**

- This interface provides 8 opto-isolated logic inputs and 8 opto-isolated logic open drain outputs.
- All in- and outputs have a common zero.
- See datasheet and manual of the INT MOD DIG for more information.

**ISOLATED CONTACTS**

- On this interface, there are 4 floating relay contacts available that can be controlled by Ethernet commands.
- This can be used to trigger an external safety alarm or to interact in automated processes.
- Floating Interlock connector (standard Interlock is at the level of Safety Earth).
- Floating Enable input to switch the output On/Off (24Vdc).
- See datasheet and manual of the INT MOD CON for more information.
- **Note:** the floating relay contacts can not be controlled by the sequencer.

**SIMULATION**

- With this interface it is possible to perform several simulations.
- One of these simulation modes is photovoltaic simulation based upon user variables.
- Other simulation modes are internal resistance, leadless sensing and fold current simulation.
- All modes are easy configurable through the web interface.
- **Note1:** simulation interface can NOT be inserted in slot1.
- **Note2:** maximum 1 simulation interface possible per unit.
- **Note3:** this interface cannot be combined with a master slave interface.
- See datasheet and manual of the INT MOD SIM for more information.

**MASTER / SLAVE CONTROL**

- The resulting combination behaves like one power supply and can be manually controlled or programmed on the master.
- Mixed parallel - series operation is also possible.
- **Note1:** maximum 1 master slave interface possible per unit.
- **Note2:** this interface cannot be combined with a simulation interface.
- See datasheet and manual of the INT MOD M/S for more information.



*fig. 7 - 8  
Digital I/O Module.*



*fig. 7 - 9  
Isolated Contacts Module.*



*fig. 7 - 10  
Simulation interface*



*fig. 7 - 11  
Master Slave interface*

## 8 TROUBLE SHOOTING / RESET BUTTON

### 1 GENERAL

- If you have a question about the unit, please contact our engineers using the address "Support@Delta-Elektronika.nl".
- In case the unit is defect, please first fill out the RMA-form before sending the unit to us. Adding a detailed fault description will help us to repair the unit as soon as possible. Do not try to repair the unit yourself.
- On our website [www.DeltaPowerSupplies.com](http://www.DeltaPowerSupplies.com) the RMA-form can be found under 'Support'.

### 2 NO DC OUTPUT

- Check the output is switched ON: the text 'ON/off' must be visible on the right side of the display.
- If the text is 'on/OFF', press the button next to this text to switch it ON if needed.
- Check the unit is not in LOCK mode: the text 'Lock' must be visible on the right side of the display.

If the text is 'Unlock', press the button next to this text for a few seconds to unlock the unit, see fig. 8 - 1.

- First set the unit in local operation (or so-called manual operation): press and hold the ON/off button for 4 seconds. On the second line of the display, before both the set values the text 'front' will be seen, now press the button next to the text on/OFF to switch on the output.
- Check the connections on the SENSE BLOCK (at rear panel). For local sensing, there should be a link between + and S+ and between - and S- (see fig. 8 - 2).

For remote sensing, the wires from S+ and S- should be connected to respectively the + and - terminals on the load.

- Check there is a link between pin 1 and pin 3 of the Interlock connector.
- Check the settings for CV- and CC-limit are set to a value greater than 0.  
Go to Menu -> Protection -> Limits.  
Here set Voltage and Current limits.
- Turn both the CV and CC encoders a few turns clockwise.  
Now a voltage should be present on the output.

### 3 PROGRAMMING DOES NOT WORK OK

- First make sure the unit works ok in local mode, see previous paragraph.
- If this is okay, check the unit is in Remote mode.  
Go to Menu -> Configuration -> Source.  
Here set the Vsettings and Isettings to the required programming source, either 'eth', 'web', 'slot1', 'slot2', 'slot3' or 'slot4'.

For example, when programming via Ethernet, on the second line of the display, before both the set values the text 'eth' must be seen.

It is also possible to only have only one of the settings in remote mode, and have the other setting in local mode.

- Enter a command to program both the CV and CC setting to a value greater than 0.  
Now a voltage should be present on the output.

### 4 MASTER / SLAVE PARALLEL PROBLEMS

- Check the voltage drop of the wiring between the master and the slaves is < 10 mV.
- Check the wiring has a low inductance.
- See interface manual for more trouble shooting.

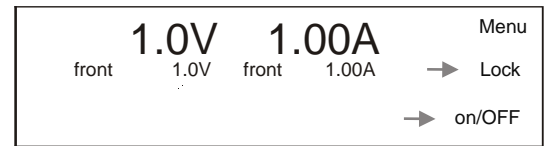

fig. 8 - 1

At the right side, the texts must be 'Lock' and 'ON/off'.

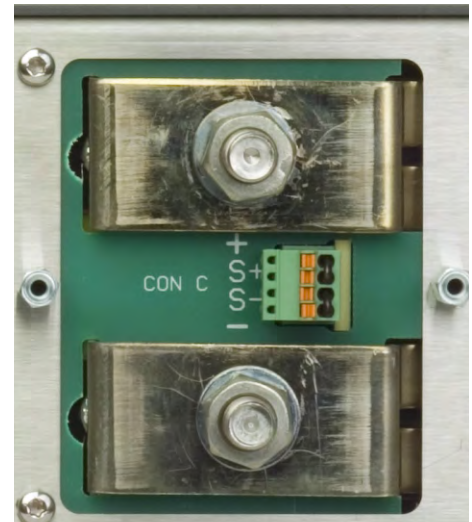

fig. 8 - 2

For normal operation links should be connected between S+ and + and between S- and -.

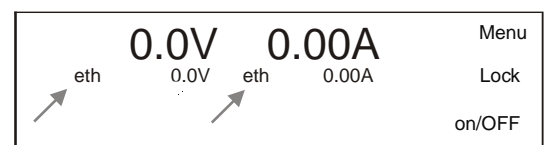

fig. 8 - 3

For Ethernet programming, the text 'eth' must be seen before the setting(s) that is/are in 'remote mode'.



## 5 OUTPUT VOLTAGE IS HIGHER THAN SET VALUE

- Check connections on SENSE BLOCK (on rear panel), For normal operation there should be a link between + and S+ and between – and S– (see also fig. 8 - 2 ).  
When remote sensing is used, check the wires of the sensing.

## 6 OT indicator blinks

- The temperature of the internal heat sink is too high, the output has been shutdown to avoid overheating.
- Check if the cooling fan is running.
- Check if the air temperature of the air inlet (left) is below 50 °C and the airflow is not obstructed.

## 7 ACF indicator on

- The input voltage is too low or was intermittent because of a bad connection. Disconnect the mains, wait a few minutes and try again.
- If the input voltage is within the specified range, there must be an internal error. Send unit for repair, see paragraph 1) of this chapter.

## 8 DCF indicator on

- The output voltage is 5% below/above the set voltage. This automatically happens when the unit is in CC-mode.
- If the output voltage is within the set value, there must be an internal error. Send unit for repair, see paragraph 1) of this chapter.

## 9 PSOL indicator on

- The Power Sink is in overload or the temperature of the Power Sink is too high. See datasheet of the Power Sink for further details.

## 10 Internal Error indicator on

- This indicator is active if there is an internal error in the unit, or when an interface is not correctly configured. Verify the "System information" page of the web interface. Or contact support.

## 11 Forgotten password, access key or network settings

- To reset the front panel access key, the password and the network settings to their default values, press the reset button at the rear panel of the unit.  
A bent paperclip can be used to press the internal micro push button (see fig 7-9).  
A soft sensible click can be noticed. Press and hold the button for at least 2 seconds in order to activate the default restoring mechanism.

## 12 Other

- If the problem is not described in the above paragraphs, please see paragraph 1) of this chapter how to contact our support department or send the unit for repair.



fig. 8 - 4

If the OT-icon is shown on the display, the unit has run hot and the output is shut down.



fig. 8 - 5

If the ACF-icon is shown on the display, the unit has not enough input power and the output is shut down.



fig. 8 - 6

If the DCF-icon is shown on the display, the output value is 5% below/above the set value.



fig. 8 - 7

If the PSOL-icon is shown on the display, the power sink has reached the power limit.



fig. 8 - 8

If the Internal Error-icon is shown on the display, the output of the unit will shut down and it has to be repaired.

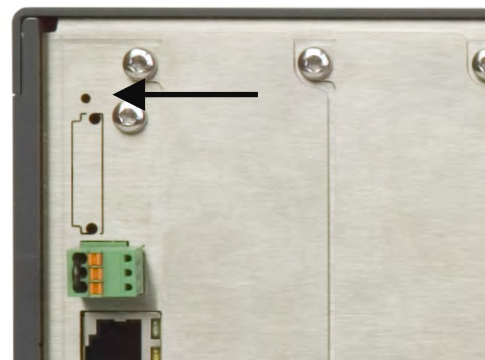

fig 7 - 9

Location of the reset button.

## 9 MAINTENANCE

### 1 GENERAL

- The SM-series power supplies do not need maintenance or calibration. However care must be taken that the cooling of the unit is not obstructed.

### 2 COOLING FAN

- The internal construction of the power supply is such that no dust will reach the sensitive control circuitry, only the heat sinks in a tunnel will be cooled by forced air (see fig. 9 - 1)
- The built up of dust on the impeller of the fan and the heat sink fins depends on the environment. It is advisable to inspect the fan and the heat sinks regularly.
- Since the fan has an over-capacity, dust will not present a problem very quickly.
- The thermal protection will shutdown the output in case of overheating, so no damage will be done to the power supply.

### 3 GALVANIC INDUSTRY

- For using the power supplies in the galvanic industry it is strongly recommended to take precautions against an aggressive environment.
- An aggressive environment with acid, salt, etc. can harm the electronic components. Sometimes even the copper tracks on the printed circuit boards dissolve.
- To avoid problems, the power supplies should be mounted in a relatively clean room, or mounted in a cabinet receiving clean air with over pressure, or a cabinet with a heat exchanger.

### 4 CALIBRATION

- The power supplies are factory calibrated and normally need no further calibration.
- After installation of a new or different interface, no calibration is needed.
- Only in special situations, for example after repairing a unit, calibration can be necessary.
- The SM3300 units can only be calibrated by software calibration. Inside the unit, there are no positions with calibration components such as trimmers or CR-resistors.
- The software calibration is performed by connecting the unit to a TCP/IP network using the LAN connector at the rear panel.
- Download the programming manual for Ethernet & Sequencer via the web interface or via [www.DeltaPowerSupplies.com](http://www.DeltaPowerSupplies.com).

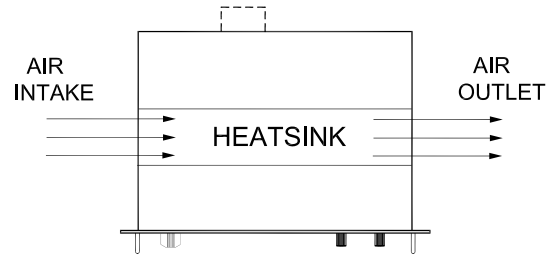

*fig. 9 - 1*  
The fan is located at the left side and blows through the tunnel.



## EU Declaration of Conformity - SM3300-series

We

Delta Elektronika  
Vissersdijk 4  
4301 ND ZIERIKZEE  
The Netherlands

Declare under sole responsibility that the following Power Supplies:

**SM 18-220**  
**SM 66-AR-110**  
**SM 100-AR-75**  
**SM 330-AR-22**  
**SM 660-AR-11**

Meet the intent of Directives

2014/30/EU Electromagnetic Compatibility (EMC)  
2014/35/EU Low Voltage Directive (LVD)  
2011/65/EU Reduction of Hazardous Substances (RoHS2)

Compliance was demonstrated to the following specification as listed in the official Journal of the European Communities:

**EN 61000-6-3:2007 Generic Emissions** (residential, light industrial)

+A1:2011

EN 61000-3-2:2014 Power Harmonics  
EN 61000-3-3:2013 Voltage fluctuation and flicker

**EN 61000-6-1:2007 Generic Immunity** (residential, light industrial)

**EN 61000-6-2:2005 Generic Immunity** (industrial environment)

**EN 60950-1:2006 Safety of IT equipment**

+A1:2010 + A11:2009 + A12:2011 + A2:2013

**EN 61010:2010 Safety of electrical equipment for measurement, control and laboratory use**

**EN 50581:2012 Assessment of electrical and electronic products with respect to RoHS**

J. Koopman  
Managing director,  
Zierikzee, December 2018