

Programmable AC Power Supply

ACPS Series

User Manual

scientific

Copyright © Scientific All rights reserved.

This instrument contains proprietary information, no part of this manual may be photocopied, reproduced or translated without any prior written consent.

Information in this manual supercede all corresponding previous released material.

Scientific continues to improve products & reserves rights to amend part or all of the specifications, procedures, equipment at any time without notice.

Ver 1.00 / 0523

Scientific Mes-Technik Pvt. Ltd.,

B-14, Industrial Estate, Pologround,
Indore 452015 (India)

Tel : 0731-2422330/31/32/33

Fax : 0731-2422334,561641

Email : sales@scientificindia.com

Website: www.scientificindia.com



Contents

Preface	5
Safety Notices	6
1 About this Manual	7
1.1 Scope	7
1.2 Targeted Audience	7
2 Unpacking	8
2.1 Packing List	8
2.2 Checking for Shipping Damage	9
2.3 Failure Repair	9
3 Products Introduction	10
3.1 Product Description	10
3.2 Product Features	10
3.3 Operation Instructions.....	11
3.4 Operation Environments	11
3.5 Maintenance and Cleaning.....	11
3.6 Product Storage	11
3.7 Power Supply Voltage.....	11
3.8 Fuse	12
3.9 Warm-up Time	12
3.10 Starting Procedure	12
4 Panel Description	14
4.1 Front Panel Description	14
4.2 Rear Panel Description	16
5 Menu Operation	18
5.1 Menu Introduction	18
5.1.1 Menu Structure	18
5.1.2 Introduction to Front Panel Operations	20
5.1.3 Key Operations and Touch Screen Operation	20
5.2 Menu Operation	22
5.2.1 Setting Item	22
5.2.1.1 Output & More Setting	23
5.2.1.2 Measurement Setting	27
5.2.1.3 Waveform Viewer Setting	30
5.2.1.4 Limitation Setting	30
5.2.2 Menu Setting	31
5.2.2.1 Config Setting.....	31
5.2.2.2 LCD Setting	38
5.2.3 Output Mode	41
5.2.3.1 PLD Testing	41
5.2.3.2 Harmonics	46
5.2.3.3 IEC Standard	51
5.2.3.4 Special Func	66
5.2.3.5 Test Mode	69
5.2.4 Parallel/Series/3-Phase	70
5.2.5 Store/Recall	70
5.2.6 Lock	72

6 Master-slave Mode Operation	73
6.1 Setting the Units as Slave	73
6.2 Setting the Unit as Master	74
6.2.1 Parallel System	75
6.2.2 Series System	76
6.2.3 3-Phase System	77
6.2.4 Error List of Master-slave Mode	81
6.2.5 Function Instruction	81
7 Calibration	83
7.1 Calibration Equipment Required	83
7.2 Calibration Procedure	83
7.2.1 Volt Setting & Measurement Calibration	84
7.2.2 Current Measurement Calibration	84
7.2.2.1 I Range High, AC Low Current Coefficient	84
7.2.2.2 I Range High, AC High Current Coefficient	86
7.2.2.3 I Range High, DC Low Current Coefficient	86
7.2.2.4 I Range High, DC High Current Coefficient	87
7.2.3 Saving Calibration Coefficient	87
8 Installation	88
8.1 Product Dimensions	88
8.2 Installing Rack Mount Handles	89
8.3 Installing the Optional Interface Cards	89
8.4 Shelf Mounting Diagram of AC Source	91
8.5 Input Connection	91
8.6 Output Connection	93
8.7 Remote Compensation	94
9 SCPI Communication Protocol	95
9.1 SCPI Commands Descriptions	95
9.1.1 IEEE-488.2 Common Commands	95
9.1.2 Measurement Commands	95
9.1.3 Setting/Query Commands	97
9.1.4 Limit Commands.....	101
9.1.5 List Commands	103
9.1.6 Pulse Commands	105
9.1.7 Step Commands	106
9.1.8 Synthesis Commands	108
9.1.9 Inter-harmonics Commands	109
9.1.10 Harmonics Measurement Commands	110
9.1.11 Master-slave Mode Commands	111
9.1.12 Dimmer Function Commands	113
9.1.13 System Commands	113
9.1.14 External Control Mode Commands	114
10 Troubleshooting	115
11 Dispatch procedure for service, E-Waste Management & Warranty.....	117
11.1 Dispatch procedure for service	117
11.2 E-Waste	117
11.3 Warranty.....	117



Preface

Dear Customer,

Thank you for using this ACPS Series Single-phase Programmable AC Power Supply. We sincerely hope this product can meet your needs.

The sections outlined in this user manual are suitable for the following product models:

Power Voltage	2U Units			3U Units	4U Units		
	600W	1000W	1500W	2000W	3000W	4000W	5000W
150VAC	5.6A	9.2A	13.8A	16A	27.6A	32A	46A
300VAC	2.8A	4.6A	6.9A	8A	13.8A	16A	23A

ACPS Series Programmable AC Power Supply are divided into Advanced Versions and Professionals Versions according to the expected needs of different power supply's application areas.

The following table lists the difference between the two versions and optional functions.

NO.	Description	Advanced Version	Professional Version
1	Output frequency range	15~1000Hz	15~1200Hz
2	IEC Standards	IEC 61000-4-11	IEC 61000-4-11, IEC 61000-4-14, IEC 61000-4-28, IEC 61000-4-13, IEC 61000-3-2, IEC 61000-3-3
3	Harmonics/Inter-Harmonics generation and measuring function	Not supported	Supported
4	Output impedance function	Not supported	Supported
5	Remote I/O & Parallel Multiphase Link Card	Optional Feature	Optional Feature
6	GPIB communication interface	Optional Feature	Optional Feature

Safety Notices



Warning!

This symbol highlights operations that have the potential to endanger users, operation procedures and instructions must be completely understood before use.



Caution!

Documentation must be consulted in all cases where this symbol is marked.

Note

This symbol highlights important instructions that need to be read before using the equipment.



This symbol indicates high voltage.



This symbol indicates parts that may be at a high temperature. Please do not touch this part of the equipment to prevent burning



This symbol indicates that a grounded condition is required before operating the equipment; the terminal with this label must be grounded to prevent electric shock.

If the equipment is used in a manner not specified by the manufacturer, the protection provided by the equipment may be impaired.

Chapter 1 About this Manual

1.1 Scope

This manual provides the reader with detailed product information as well as installation, operation and maintenance instructions.

1.2 Targeted Audience

This manual is intended for product users and technical personnel that are involved with installing operating and maintaining the product. Readers are required to have a certain degree of electrical and mechanical knowledge and be familiar with basic electrical and mechanical schematics.

Chapter 2 : Unpacking

2.1 Packing List

Item	Descriptions	Quantity	Remarks
A	ACPS Series Programmable AC Power Supply	1	As ordered
B	Rack Mount Brackets	2	Standard
C	Output Terminal Cover Box	1	Standard
D	Input Terminal Cover Box	1	Standard
E	Screws	12	Fasten item B
F	RS-232 Communication Cable	1	Standard
G	LAN communication Cable (568A-568B)	1	Standard ^[1]
H	Power Cord ^[2]	1	Standard
I	USB Communication Cable	1	Standard
J	GPIO Communication Cable	1	Optional
K	System Bus Communication Cable (DVI)	1	Optional
L	BNC Cable	1	Optional

[1] The LAN communication cable is optional for 2 U units.

[2] 2U model is standard with three-pin plug power cable (16A). 3U/4U model is standard with power cable(1.5M).

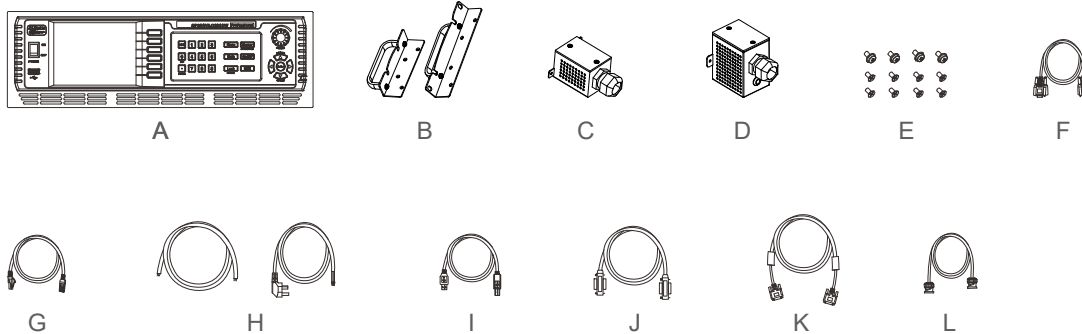

2.2 Checking for Shipping Damage

All products have undergone stringent testing before delivery, but inevitably damage can happen during transportation. Once you receive the product, please immediately check if there is any packaging damage that may indicate damage to the product. If you find damage related to product delivery, please immediately notify the transporter & our company.



Caution!

- The handles on the front panel are for sliding in and out of the cabinet NOT for carrying.
- Because of its weight, transport by hand should be avoided where possible. If unavoidable then only the housing should be held and not on the exterior parts (handles, input/output terminals or rotary knobs).

2.3 Product Damage or Failure

In the unlikely event of product failure, please promptly contact us and provide the serial number of the faulty AC power source, detailed fault information and pictures to help us identify the cause of the failure. If the power source requires repairing at the factory or repair center, please pack it in the original packing material. Please assure to contact us to receive prior authorization for the product return and return instructions.

Chapter 3 : Product Introduction

3.1 Product Description

This series of products is single phase programmable AC power sources, incorporate high frequency PWM techniques, high speed DSP+CPLD control to provide low-distortion sine wave output or other wave-shapes as needed. An isolated active input Power Factor Correction (PFC) input power processing stage is used to efficiently provide a low THD high power factor input characteristic.

The product includes comprehensive measurement functions and remote control and communications. The units feature standard 19" (48.3 cm) rack or bench-top mounting, many system based functions, local touch screen display and selector soft keys / knobs, remote analog and digital input control of its' operation. It is designed to meet the needs of a wide range of applications.

3.2 Products Features

- A large color easy to operate touch screen display that possess a complete set of functions.
- Support for USB data import/export and screen snapshot from its' front panel.
- AC and DC mixed or independent output modes for voltage DC offset simulation.
- Maximum output voltage and current limit restriction setting capability. Support for constant current output mode.
- Output voltage and frequency slope setting capability.
- Turn ON / Turn OFF phase angle setting capability.
- LIST / PULSE / STEP modes, which are suitable for simulation of power line disturbance tests.
- Sweep Function.
- Transient mode function.
- Phase Angle Dimmer simulation function.
- Reverse current protection.
- Built-in output metering capable of measuring 15 electrical parameters including output voltage, current, frequency, etc.
- Suitable for IEC 61000-3-2 and IEC 61000-3-2 tests.
- IEC 61000-4-11 / IEC 61000-4-14 / IEC 61000-4-28 / IEC 61000-4-13 standard test requirement waveforms are built-in.
- Support for up to 2 units connected in series, 4 units connected in parallel and 3 units combined to provide a 3-phase output. Presently, 2U units can not support multi-unit mode.

3.3 Operating Instructions

This product is a precision instrument, please read this manual carefully before using. In order to ensure measurement accuracy it is recommended that this unit is calibrated annually.

To ensure the user safety, the input power cable, connector and accessories of this product should be inspected at least annually.

3.4 Operating Environments

1. These power sources must be used in a clean and dry laboratory or testing environment with an ambient temperature of between 0°C and 40°C and a relative humidity of between 5% and 95%.
2. Do not use this power source in a high temperature ambient for a prolonged period. Please cease to use this product if its' case temperature exceeds 45 degrees Celsius. Long term operation of this product at a high ambient temperature may cause OTP (over temperature protection) action.
3. For adequate air circulation please ensure that 30 cm of space is present at the front and back of the unit. Internal fans cool the power source by drawing air through the front and exhausting it out the back.
4. Do not operate this product in an environment that contains large amounts of dust or corrosive gases. Please do not subject the unit to strong shock and vibration or expose it to intense direct sunlight.

3.5 Maintenance and Cleaning

Before cleaning, you must disconnect the input power cord of this power source. Gently wipe off any dust from the units exterior using a brush or sponge or one can use only a small amount of non-aqueous cleaning solution such as isopropyl alcohol on a clean cloth. Do not use a corrosive or abrasive cleaning solution to clean this product. The display front panel can be cleaned with cloth dampened in soft detergent. Cleaning of dust from the interior of this product must be carried out with a low pressure air gun, and to prevent damage to internal components we suggest that such cleaning be performed by an authorized dealer on behalf of the user.

3.6 Product Storage

Please store this product in an area with a temperature between -40°C and 85°C and with a relative humidity of between 5% and 95% non-condensing. If the product is not going to be used for a long period, please keep it in the original carton or other similar packaging and store it in a cool & dry place.

3.7 Power Supply Voltage

Make sure that the front panel power switch is in the OFF state and the AC input mains voltage is within the product's operating specification before plugging in or connecting to the AC mains.



Caution!

- The protective safety earth/ground connection must be connected first and disconnected after the AC mains line and neutral wires. All approved AC power connectors are designed to meet this requirement. If the input wires are directly connected to an AC mains circuit assure that the AC source is deactivated prior to making or disconnecting the connection.

3.8 Fuse

The input AC fuses installed inside the product are designed to protect the units' input from major component failures, and they should not fail under normal operating conditions. Accordingly, any fuse failure is an indication that other parts of the product are damaged. If the input fuses open circuit we recommend that the product be sent back to us for repair.



Warning!

- Danger of electric shock. No user serviceable components enclosed. Do not disassemble the power's enclosure / case to replace the fuse.

3.9 Warm-up Time

Once the power source is switched on the unit will enter a start-up routine that when completed which will verify proper unit operation. All features of the unit are operable after this routine has been successfully completed. In order to achieve the specified operating accuracy, it is recommended to allow the power supply to warm-up for a period of 30 minutes before use.

3.10 Starting Procedure

Plug in the AC power and turn on the power switch on the front panel, the programmable AC power source will execute a self-checking routine:

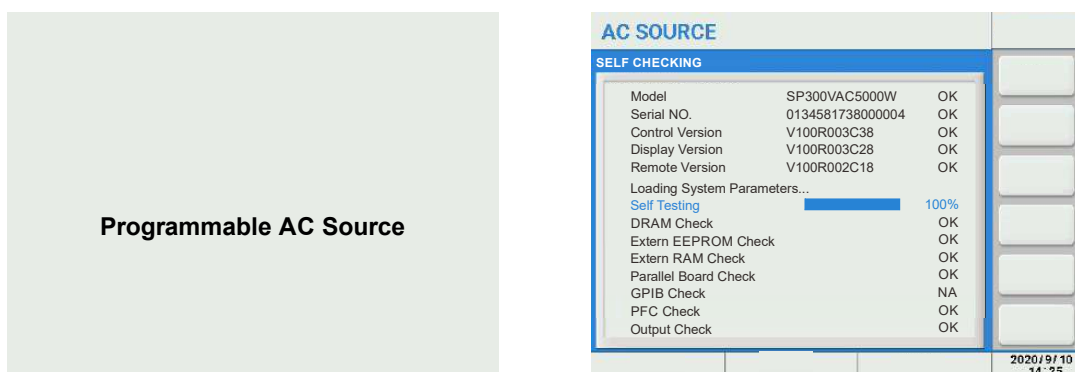

After 3 seconds, it will enter the self-testing mode;

DRAM Check : checks DRAM, if failed, shows as FAIL;

Extern EEPROM Check : checks the external EEPROM memory, if failed, shows as FAIL;

Extern RAM Check : checks the external RAM memory, if failed, shows as FAIL;

Parallel Board Check : checks whether remote I/O and parallel link board is installed and connected, if not, shows as NA.

GPIB Check : checks whether the GPIB communication board is being connected, if not, shows as NA.

PFC Check : checks the units PFC board operation, if not operating correctly it shows as FAIL.

Output Check : checks the units output of 150V both 300V ranges, if the output voltage is not within $100V \pm 8V$ and $200V \pm 8V$ it shows as FAIL.

Note: If the PFC Check or Output Check shows a FAIL result, the power source will not operate. If there is a FAIL result in any of the other tests, the power source is still operational. In this case, press the [Enter] key to proceed to the MAIN screen.

Chapter 4 : Panel Description

4.1 Front Panel Description

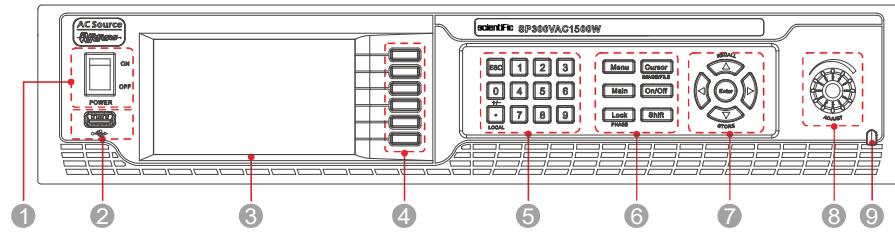

Front Panel of 2U Models

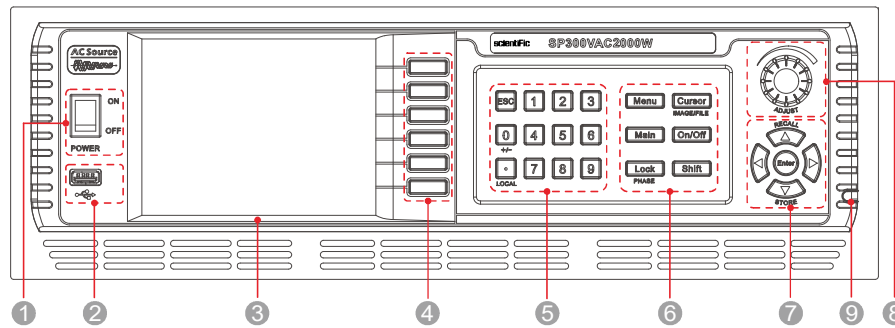

Front Panel of 3U Models

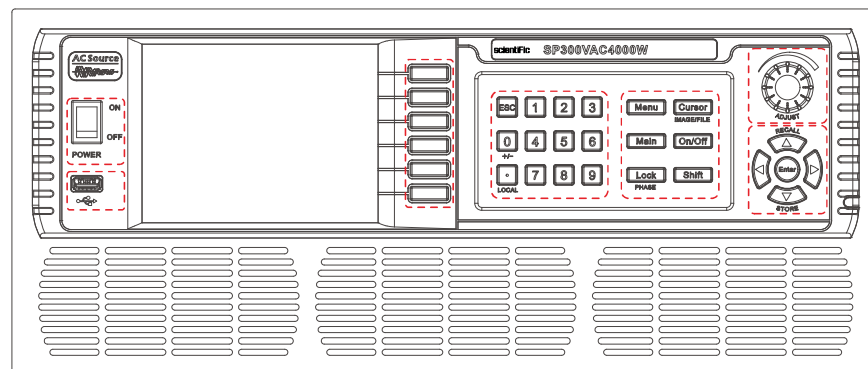

Front Panel of 4U Models

- ① Input power switch.
- ② USB port is for data transfers and upgrading software.
- ③ Color touch screen.
- ④ Operation selection soft keys, to select displayed menu functions.
- ⑤ Numeric and functional keys.

Keys	Name and the function	Manual Reference
	Numeric keys.	[0]~[9]
	Decimal point key.	[.]
	Esc key.	[ESC]
+/- (Shift +	To set the direction of DC offset.	[Shift]+[0]
LOCAL(To select front panel operation / keypad unlock function key, used to unlock the panel buttons.	Local([.])

⑥ Functional keys and multifunctional keys

Keys	Name and the function	Manual Reference
	To enter function setting items.	[Menu]
	Cursor to highlight desired selection.	[Cursor]
	Press to return to the Main screen.	[Main]
	To turn the output of AC source On or Off.	[On/Off]
	Press to lock the front panel keys.	[Lock]
	This shift key is used to select the alternate operation of a key, indicated by the word under the key.	[Shift]
IMAGE/FILE(Shift +	Screen snapshot/importing/firmware upgrade.	[Shift]+[Cursor]
PHASE(Shift +	1-phase mode or 3-phase mode.(unavailable)	[Shift]+[Lock]

⑦ Confirm key and multifunctional keys.

Keys	Name and the function	Manual Reference
RECALL(Shift +	Recall the setup from internal memory.	[Shift]+[▼]
STORE(Shift +	Store the settings in non-volatile memory.	[Shift]+[▲]
	Up/Left key.	[◀]
	Down/Right key.	[▶]
	Confirm key.	[Enter]

- ⑧ Rotary knob, used to navigate menu items or for incrementing/decrementing values one step at a time or to move cursor position.
- ⑨ Stylus (Touch pen) for accurately touching the touch screen display.

4.2 Rear Panel Description

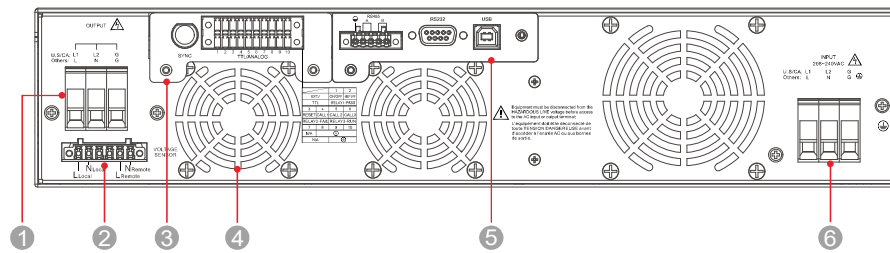

Rear Panel of 2U Models

- ① AC/DC output terminals.
- ② Voltage sensor terminals.
- ③ Remote I/O card (Optional).

Interface	Description
SYNC	BNC connector input by external analog signal to control waveform amplitude.
TTL/ANALOG	TTL signal/analog input interface.

External Control Instruction

EXT. V

Pin 1	ON/OFF	OUTOFF = Low (0~0.5V); OUTON = High (4.5~5.5V)
Pin 2	KEEPOFF ^[1]	KEEPOFFDisable = Low (0~0.5V); KEEPOFFEnable = High (4.5~5.5V)
Pin 3	RESET	RESETActive = Low (0~0.5V); RESETNOT Active = High (4.5~5.5V)
Pin 4	CALL 1	0 = Low (0~0.5V); 1 = High (4.5~5.5V)
Pin 5	CALL 2	0 = Low (0~0.5V); 1 = High (4.5~5.5V)
Pin 6	CALL 3	0 = Low (0~0.5V); 1 = High (4.5~5.5V)
Pin 7	N/A	Not Used
Pin 8~10	⊕	GND

[1] If the KEEPOFF signal keeps high (enable) there will be always no output.

TTL

Pin 1~2	RELAY1-PASS	These two pins will connected internally when the unit passed the test mode.
Pin 3~4	RELAY2-FAIL	These two pins will connected internally when the unit failed the test mode.
Pin 5~6	RELAY3-RUN	These two pins will connected internally when the unit is running.
Pin 7~8	RELAY 4	Not Used
Pin 9~10	⊕	GND

- ④ Cooling air outlet.
- ⑤ Standard communication interfaces, RS-485, RS-232 and USB. LAN and GPIB is optional.
- ⑥ Input terminals.

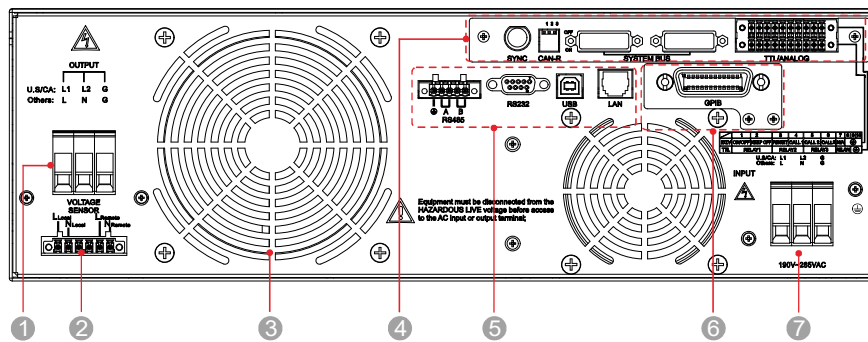

Rear Panel of 3U Models

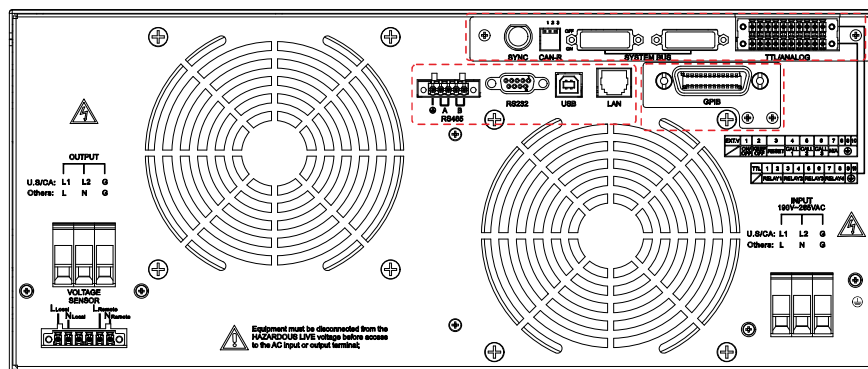

Rear Panel of 4U Models

- ① AC/DC output terminals.
- ② Voltage sensor terminals.
- ③ Cooling air outlets.
- ④ Remote I/O & Parallel Multiphase Link card (Optional).

Interface	Description
SYNC	BNC connector input by external analog signal to control waveform amplitude.
CAN-R	Connect CAN-R in parallel mode.
SYSTEMBUS	Used for communication between master and slaves.
TTL/ANALOG	TTL signal/analog input interface.

- ⑤ Standard communication interfaces, RS-485, RS-232, USB and LAN.
- ⑥ GPIB communication interface, optional.
- ⑦ Input terminals.

Chapter 5 : Menu Operation

5.1 Menu Introduction

5.1.1 Menu Structure

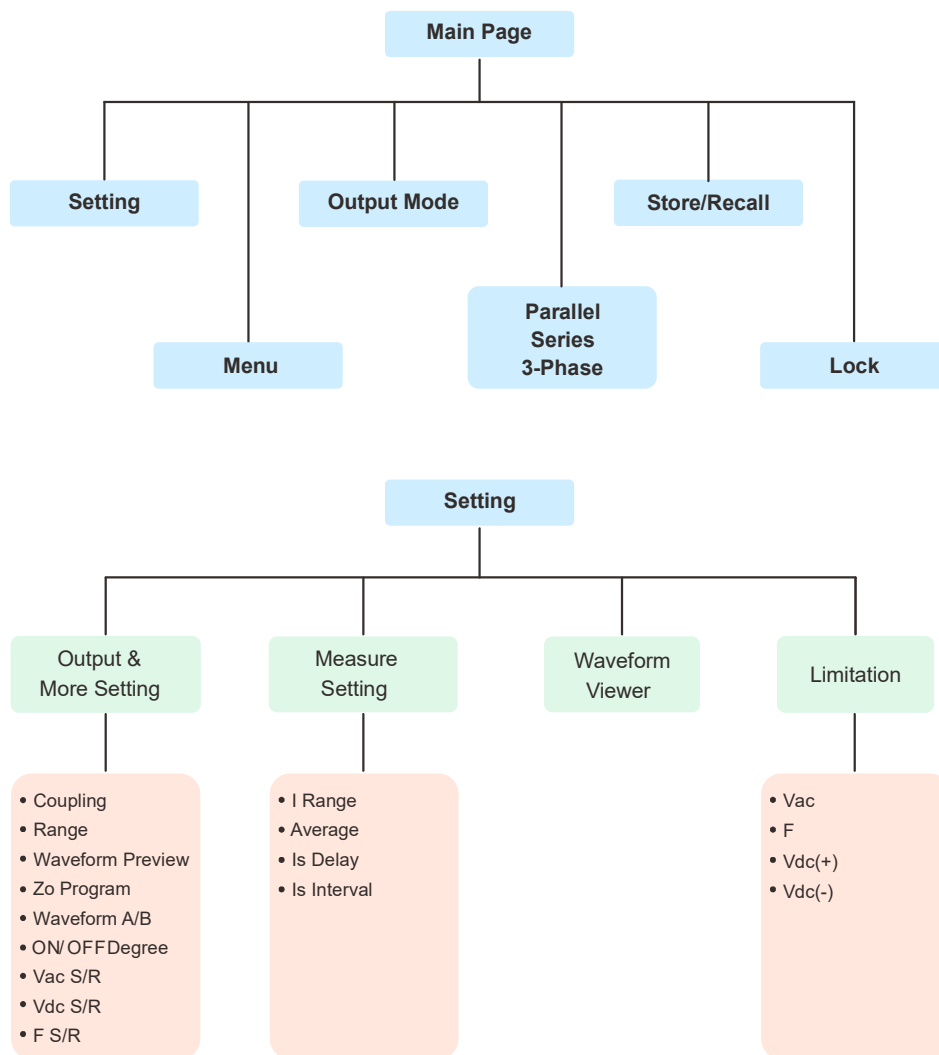

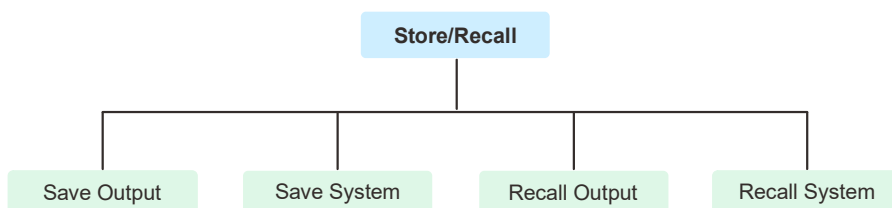
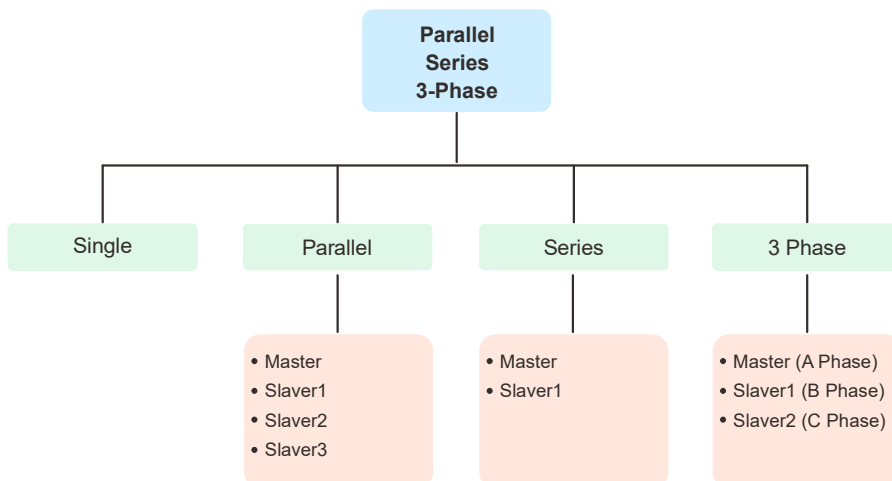
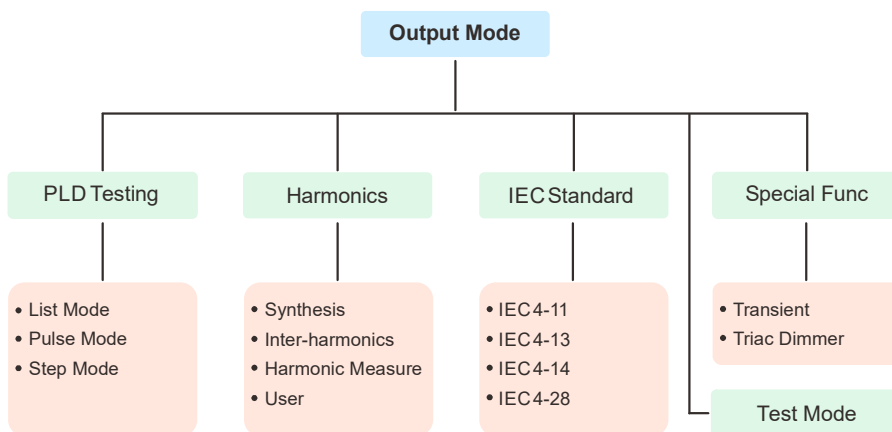
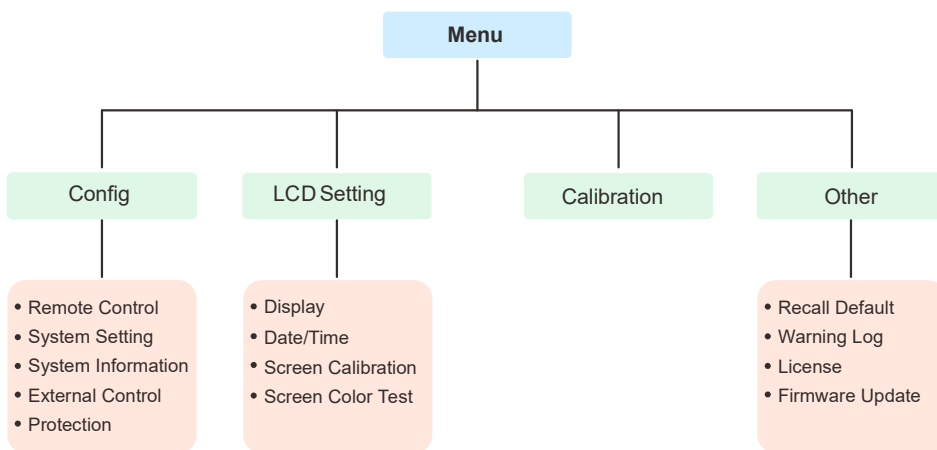

5.1.2 Introduction to Front Panel Operations

Note

- The Default setting values will be used if setting values are not saved before restarting.
1. Front panel **On/Off** key is used for turning the power source On or Off.
 2. Control modes include Front Panel control, Remote control and External control modes, the first two can be selected by a connected computer. The operating mode can be changed without affecting the power supply output.
 3. All front panel keys are functional when the power supply is in Front Panel operation mode.
 4. Under remote operation mode, all Front Panel keys except the decimal point key are locked.

5.1.3 Key Operations and Touch Screen Operations

Most of the menu function can be executed by front panel keys or touch screen. However, a few of the menu function can not be carried out by using the touch screen.

Voltage setting

Option one (using front panel keys)

1. Press the [Cursor] key, then press the right or left arrow keys will to allow the cursor to scroll through the settable parameters.
2. Move the cursor to the value line of 'Vac=', press the numeric keys [0]~[9] to set the desired output voltage value, and then press the [Enter] key to confirm. The output frequency can be set in a similar manner.

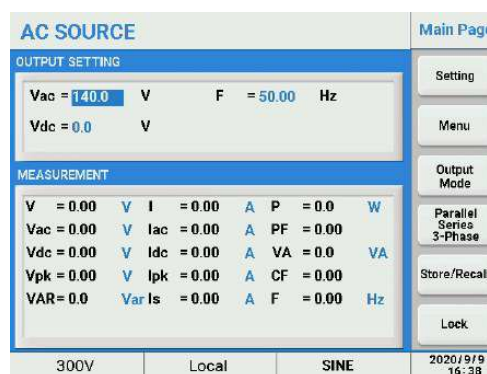
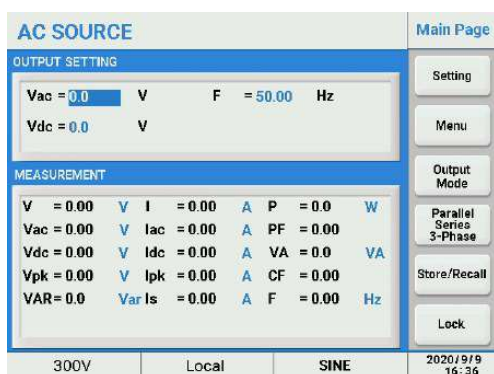

OR

3. Once this value field is highlighted press the rotary knob, an underline cursor will be displayed under the value as show as below(left). Pressing the front panel knob again will change the cursor position, rotating the front panel knob or pressing the numeric keys will adjust the particular digits value. When the desired output voltage value is displayed press the [Enter] key to confirm.

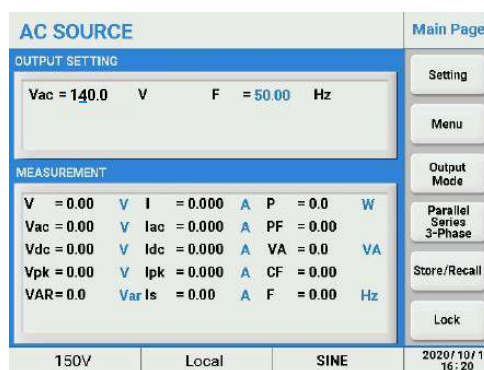
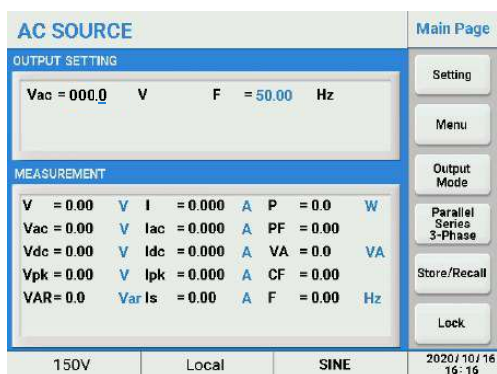

Option two (using touch screen)

1. Touch the desired value area, a small keyboard will be displayed as shown below.
2. Touch the numeric keys [0]~[9] as desired, then touch the [Enter] key on the small keyboard to confirm.

Hint: Using the supplied stylus (touch pen) stored in the far right of the front panel is easier and more precise than using one's finger to touch the front panel screen. Be sure to place the Stylus back in its storage location after use to prevent loss.

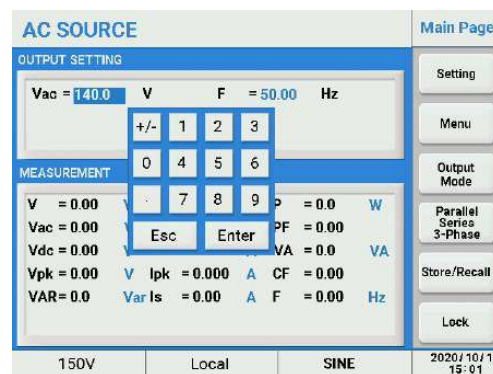
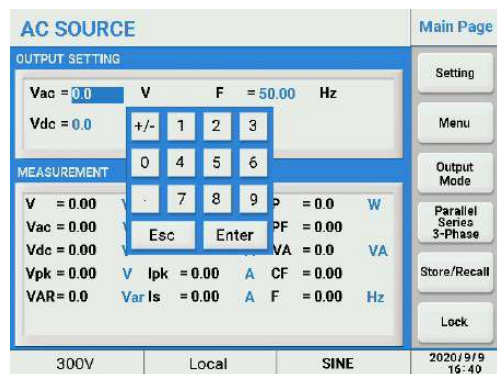

Menu setting

Option one (using front panel keys)

1. Press the 'Coupling' soft key to display the output coupling options.
 2. Press the [▲] / [▼] key to highlight AC+DC option, then press the [Enter] key to confirm.
- OR
3. Scroll knob to highlight AC+DC option, then press the knob to confirm.



Option two (using touch screen)

1. Touch the 'Coupling' soft key directly to display the options.
2. Touch the 'AC+DC' option to confirm.



5.2 Menu Operation

We will explain menu operation using the front panel keys as touch screen operation is self explanatory.

5.2.1 Setting Item

The following Soft Keys are available in the Setting screen to access these setup screens.

- Output & More Setting
- Measure Setting
- Waveform Viewer
- Limitation

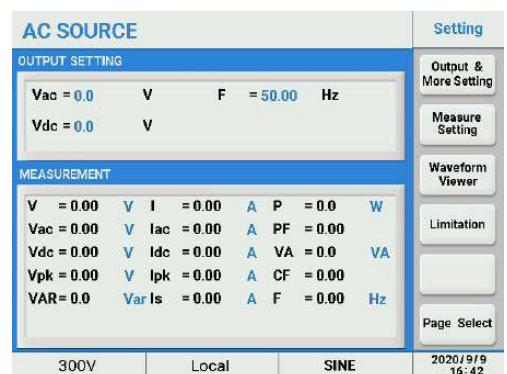

5.2.1.1 Output & More Setting

This screen allows control over the following output settings using these soft keys:

- Coupling
- Range
- Waveform Preview
- Zo Program



1. Output Coupling

This menu is for setting the output mode of the AC source including 'AC', 'DC', and 'AC+DC' modes. For example, to set 'Coupling' as 'AC+DC'.

1. In the 'More Settings' screen, press the 'Coupling' soft key to display the drop down list.
2. Rotate the front panel knob to highlight the 'AC+DC' option then press the front panel knob or the [Enter] key to confirm.



AC+DC

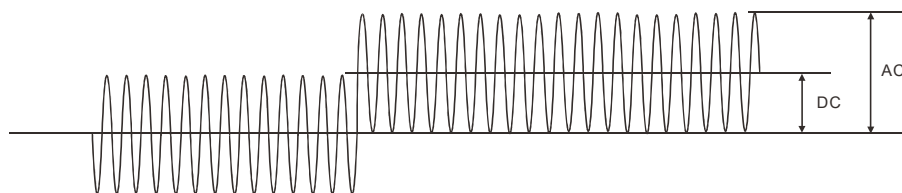

Note: In AC+DC coupling mode, any combination of AC and DC voltage may be selected as long as the positive or negative peak voltage of the combined output does not exceed the allowable maximum peak voltage. Refer to figure above.

2. Range

This menu is for setting the output range of the AC source which includes Low Range '150', High range '300', and 'Auto'. When Auto is chosen, the switchover between High range and Low range will be performed by the instrument automatically.

For example, to set 'Range' as 'Auto'.

1. In the 'More Settings' screen, press the 'Range' soft key to display the drop down list.
2. Rotate knob to highlight 'Auto' option then press the front panel knob or the [Enter] key to confirm.



Note

- When changing the range setting, turn off the AC source output first. The Range setting can not be changed if the output is on.
- There is a temporary OFF (approx. 300ms) to the AC source during the switchover of range.
- Range setting will always be displayed on the lower-left corner of the display.

3. Waveform Generators

The AC source provides the user with two independent waveform generators, A and B. Both of the waveform generators include SINE (sinusoidal), SQUARE clipped sinusoidal (CSINE), FIXED (30 sets of built-in waveforms), USER (6 sets of user-defined waveforms) wave-shapes. For example, to set waveform B as SQUARE

1. In the 'More Settings' screen, move the cursor to highlight the displayed Waveform A, then press the [Enter] key to change to Waveform B.
2. Move the cursor to the value field of Waveform B, then press the [Enter] key to show the waveform selection list, rotate the front panel knob to highlight 'SQUARE', then press the [Enter] key to confirm.



4. Degree Setting

This item is for editing the start and end angles of the AC output when the output is turned on and turned off. The 'ON Degree' (start angle) range is 0~359.9 degrees. The 'OFF Degree' (end angle) range is 0~359.9 degrees and 'Disable'. The AC source will stop its output immediately when the user turns the unit off when 'OFF Degree' is set as 'Disable'. For example, to set 'ON Degree' as 180 degrees and 'OFF Degree' as 90 degrees.

1. In the 'More Settings' screen, move the cursor to highlight 'ON Degree = ' field, press [1]~[8]~[0] and [Enter] keys to confirm.
2. Move the cursor to highlight 'OFF Degree = ' field, press the [Enter] key to change to settable status, then press the [9]~[0] and [Enter] keys to confirm.

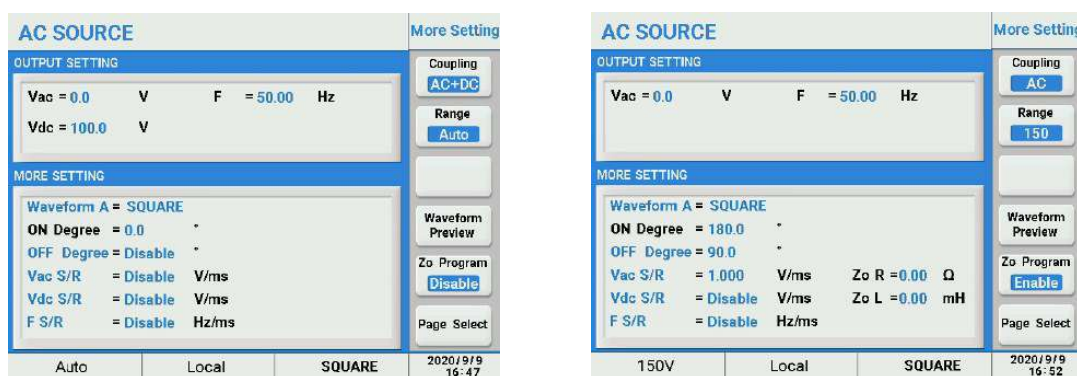

5. Slew Rate Setting

This item is for setting the slew rate of AC output voltage, DC output voltage, and Frequency.

'Vac S/R' range is 0.001V/ms~1200.000V/ms, or Disable;

'Vdc S/R' range is 0.001V/ms~1000.000V/ms, or Disable;

'F S/R' range is 0.001Hz/ms~1600.00Hz/ms, or Disable;

For example, to set 'Vac S/R' as 10V/ms.

1. In the 'More Settings' screen, move the cursor to highlight 'Vac S/R', then press the [Enter] key to change to settable status.
2. Move the cursor to highlight 'Vac S/R = ' field, then press [1]~[0] and [Enter] keys to confirm.

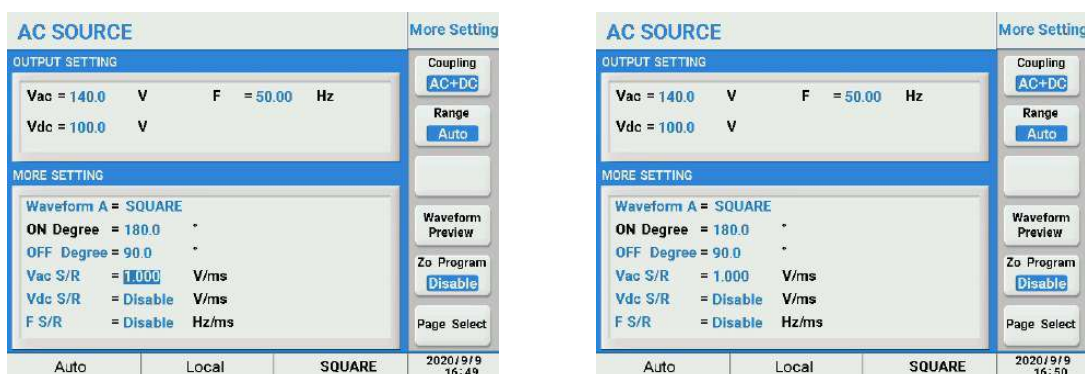

Note

- If the user programs a slew rate setting, the ON Degree (start phase angle) of an AC output waveform may not be directly visible. It can be inferred however from the waveform cycle and frequency setting.

6. Waveform Preview

This item is for preview the currently selected waveform.

1. In the 'More Settings' screen, press the 'Waveform Preview' soft key to display the currently selected waveform.

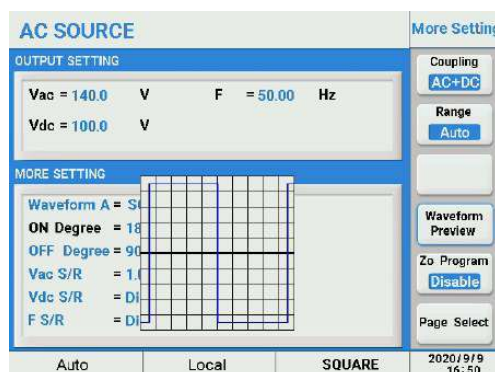

7. Zo Program

This item is for setting the internal output impedance Zo which consists of simulated output resistance (R) and inductance (L). 'R range' is 0.01~1.00 ohms, 'L range' is 0.01~1.00 mH. For example, to set 'Zo R' as 0.5 ohm.

1. In the 'More Settings' screen, press the 'Zo Program' soft key to enable this function.
2. Move the cursor to highlight 'Zo R=' field, then press [0]~[.]~[5] and [Enter] keys to confirm.



Warning!

- The upper limit for Programmable output impedance is 1.0 Ohm / 1.0 mH. If L is more than 0.5 mH and the output voltage is low (e.g. less than 100Vac), any large load current may cause an unstable output voltage. It is important that the user adjusts the L value slowly while monitoring the output voltage and listening for any unusual sounds coming from the power source. If any unusual high frequency output voltage is observed or any abnormal sound is heard, DONOT use this feature. Instead, use an external actual impedance circuit in series with the load.

5.2.1.2 Measurement Setting

The AC source support 15 different output measurements. All 15 can be displayed at the same time in the Measurement display area of the Main screen.

1. In the 'Settings' screen, press the 'Measure Setting' soft key to display the 'Measure' screen shown below.
2. Move the cursor to highlight the position you would like to edit, then press the [Enter] key to display a on-screen touch pad containing all 15 measurements and a Hide button. Select the desired read-out at this position by pressing it or press Hide if you want no readout at this position.

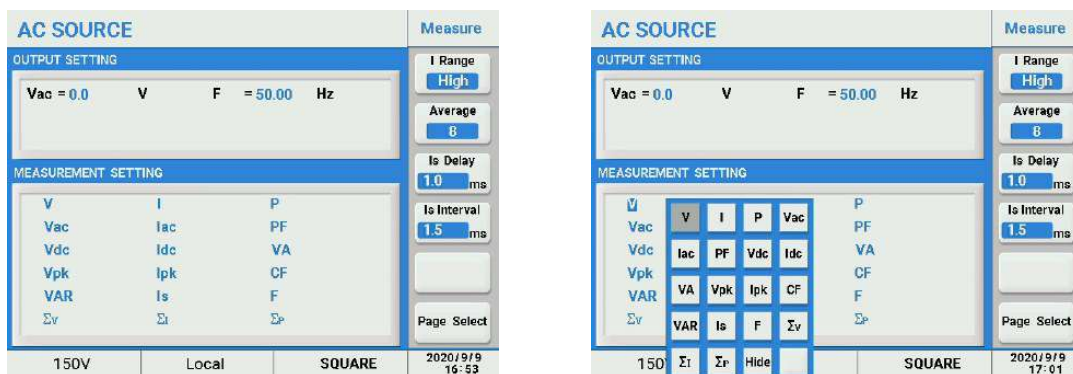

Glossary of Terms

V : the RMS of total output voltage (Vac and Vdc), measured in volts.

Vac : AC output voltage, measured in volts.

Vdc : DC output voltage, measured in volts.

Vpk : Peak-peak output voltage, measured in volts.

I : the RMS of total output current (Iac and Idc), measured in amps.

Iac : AC output current, measured in amps.

Idc : DC output current, measured in amps.

Ipk : Peak-peak output current, measured in amps.

Is : surge current, measured in amps.

F : the output frequency, measured in Hz.

PF : output power factor, $PF = P/VA$.

CF : crest factor, $CF = Ipk/I$.

VA : the apparent power consumed by the load due to real and reactive circuit components, measured in VA.

VAR : the power absorbed by capacitive or inductive elements in a circuit, measured in VAR

P : active power, measured in watts.

The following four Soft keys are available in the Measurement Settings screen:

- I Range
- Average
- Is Delay
- Is Interval



1. I Range

The I Range soft key allows selection of the current measurement range.

Available settings are High, Middle, Low, Auto and mA.

For example, to set I Range as Low.

1. In the 'Measure' screen, press the soft key to the right of 'I Range'.
2. Rotate knob to highlight 'Low' and press the [Enter] key to confirm.



Note

- The Auto range selection will only be switched between High and Middle range.
- To change settings between High/Middle and Low/mA ranges, the power source must be turned off first.

2. I Average

The Average soft key changes the number of times a reading is averaged before the corresponding measurement parameter display is updated.

Available average values are 1, 2, 4, 8, 16 and 32.

For example, to set Average time as 2.

1. In the 'Measure' screen, press the 'Average' soft key to display the drop down list.
2. Rotate the front panel knob to highlight '2' and then press the [Enter] key to confirm.

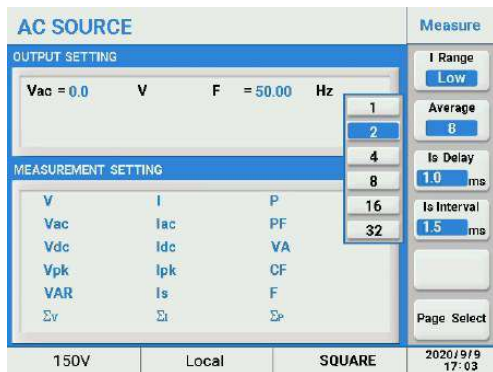

3. Is Delay, Is Interval

Is Delay defines the delay time between the beginning of the output voltage transition to the start of the measurement of I surge.

Is interval defines the measurement time.

For example, to set 'Is Delay' as 10ms.

1. In the 'Measure' screen, press the soft key to the right of 'Is Delay'.
2. Press [1]~[0] and then [Enter] keys to confirm.

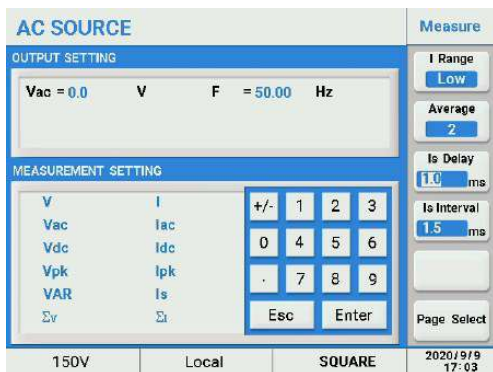

5.2.1.3 Waveform Viewer Setting

This item is for viewing the currently selected waveform.

In the 'Settings' screen, press the 'Waveform Preview' soft key to display the currently selected waveform. Press the [ESC] key to turn off the viewer.

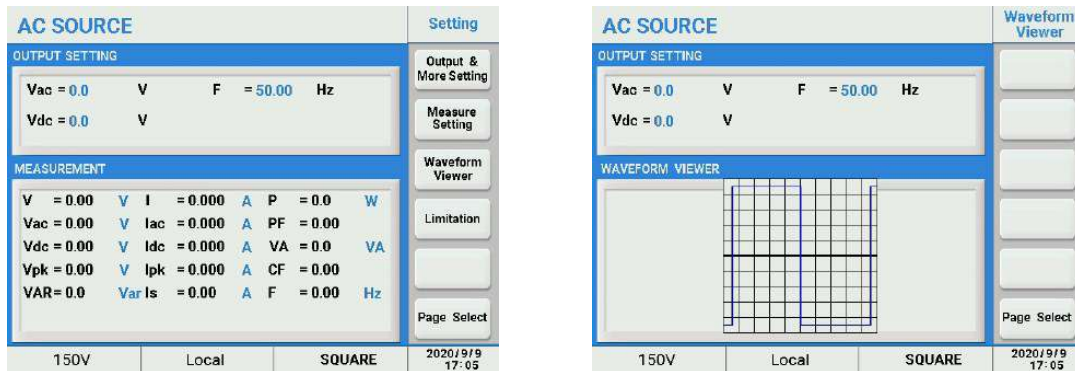

5.2.1.4 Limitation Setting

The limitation soft key displays the user limit setting screen. User limits are useful to protect a unit under test from operator error by setting upper and or lower parameter value limits for key output parameters like voltage and frequency.

'Vac' range is 0~300V.

'F' range is 15~1200Hz.

'Vdc(+)' range is 0~424.2V, 'Vdc(-)' range is -424.2V~0.

For example, to set the maximum output AC voltage.

1. In the 'Limitation' screen, move the cursor to highlight 'Vac =' field, press the desired [0]~[9] keys and then [Enter] key to confirm.
2. Or, press the 'Set to Maximum' soft key directly.

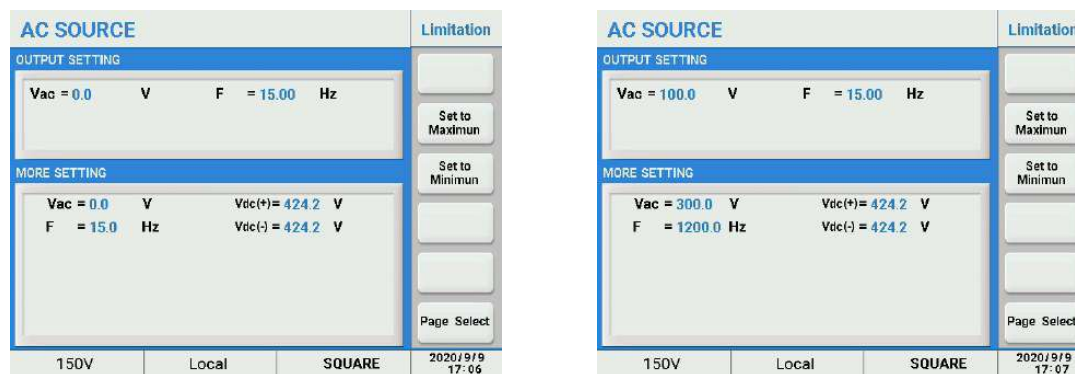

Note

- User limits are independent of the selected voltage range so an upper Vac limit setting higher than 150V will have no effect while on the 150V AC voltage range as the voltage range limit supersedes the user limit.

5.2.2 Menu Setting

The following soft keys are available in the Menu screen to access these settings:

- Config (Configuration)
- LCD Setting
- Calibration
- Other

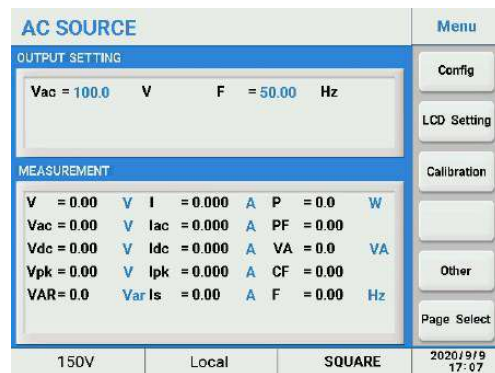

5.2.2.1 Config Setting

The Config screen controls the following aspects of the power source:

- Remote Control
- System Setting
- System Information
- External Control
- Protection

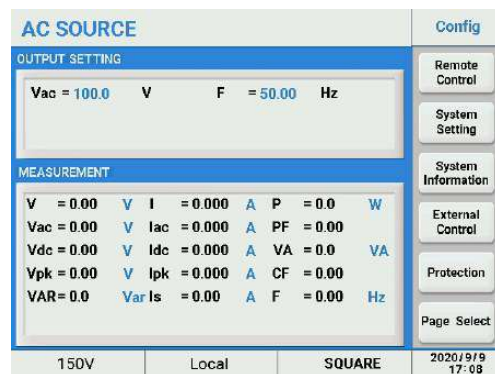

1. Remote Control

The Remote Control screen provides access to RS-232, RS-485, GPIB and LAN interface.

1.1 RS 232

Baud Rate, available rates are: 9600, 19200, 38400, 57600, 115200.

Parity Type: NONE, ODD, EVEN

Stop Bits: 1, 2.

For example, to set Baud Rate to 19200.

1. In the 'Remote Control' menu, press the 'RS232' soft key to change RS232 interface settings.
2. Move the cursor to highlight 'Baud Rate =' field then press the [Enter] key to confirm.
3. Rotate the front panel knob to highlight '19200', and then press the [Enter] key to confirm.

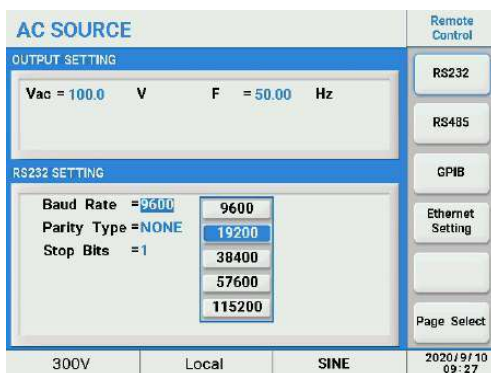

1.2 RS485

Available Baud Rate are: 9600, 19200, 38400, 57600, 115200.

'Parity Type': NONE, ODD, EVEN

'Stop Bits': 1, 2.

'485 Addr': 1~254.

For example, to set '485 Addr' as 5.

1. In the 'Remote Control' menu, press the 'RS485' soft key to change RS485 settings.
2. Move the cursor to highlight '485 Addr =' field, then press [5] and [Enter] keys to confirm.



1.3 GPIB

'GPIBAddr': 1~30.

For example, to set 'GPIBAddr' as 5.

1. In the 'Remote Control' menu, press the 'GPIB' soft key to change GPIB interface settings.
2. Move the cursor to highlight 'GPIBAddr =' field, then press [5] and [Enter] keys to confirm.

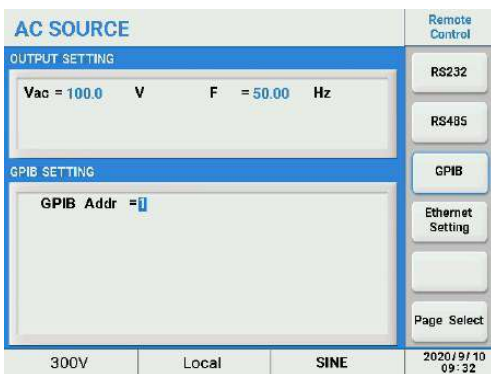

1.4 Ethernet Settings

Parameter ranges are:

ETH Setting: Auto, Manual.

IP Address: 0~255

Net Mask: 0~255

Gate Way: 1~254

The default settings for the Ethernet interface are as follows:

ETH Setting = Manual

IP Address = 192.168.1.100

Net Mask = 255.255.255.000

Gate Way = 192.168.1.1

Listen Port = 2001

For example, to set IP Address as 192.168.1.99.

1. In the 'Remote Control' menu, press the 'Ethernet Setting' soft key to change LAN interface settings.
2. Move the cursor to highlight 'ETH Setting =' field, press the [Enter] key to confirm.
3. Rotate the front panel knob to highlight the 'Manual' item, press the [Enter] key to confirm.
4. Move the cursor to highlight the setting area and press [0]~[9] and [Enter] keys to confirm.



2. System Settings

This item is for setting the basic operation of the system including 'Buzzer', 'P/O State' and 'O/P Relay'.

2.1 Buzzer

The buzzer of the AC source beeps when the user presses the keypad on the front panel, or press the PRGknob. If the user does not want it to sound it can be disabled.

For example, to set 'Buzzer' to OFF

1. In the 'System Setting' menu, press the 'Buzzer' soft key to change the state of the buzzer.
2. Rotate the front panel knob to highlight the 'OFF' option then press the [Enter] key to confirm.



2.2 P/O State

The AC source allows the user to store the output settings as the default settings before powering the unit off.

If 'OFF' is selected the unit will NOT store any settings when powered off and initialize with factory default at power on.

If 'LAST' is selected the unit will store the last setting in effect when powered off and recall this same setting at power on.

If 'USER' is selected a user-defined setup can be assigned for recall when the power source is turned on.

For example, to set 'P/O State' as USER, 'Couple' set as AC+DC, 'Vac' set as 100V, 'F' set as 50 Hz, and 'Vdc' set as 20V.

1. In the 'System Setting' menu, press the 'P/O State' soft key and scroll to the User entry, then press the [Enter] key to confirm.
2. Move the cursor to highlight 'Couple =' field, then press the [Enter] key to confirm.
3. Rotate the front panel knob to highlight the 'AC+DC' option, then press the [Enter] key to confirm.
4. Use the [0]~[9] number keys as desired and [Enter] key to set 'Vac', 'F', and 'Vdc' settings.

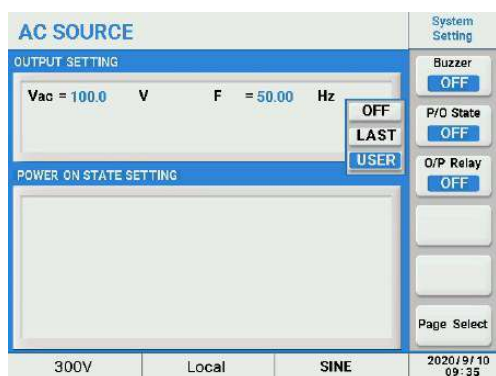

2.3 O/P Relay

There is an isolation relay to connect or disconnect the load from the output of the power source.

When 'O/P Relay' is 'ON', the relay always remains closed, regardless of the programmed output state, even if the output state is OFF. When the output relay is set to 'OFF', the output relay will close when the output state is ON and open when the output state is OFF. This is 'normal' operation for most power sources and should be the default setting.

For example, to set 'O/P Relay' as ON'.

1. In the 'System Setting' menu, press the 'O/P Relay' soft key to display the drop down list.
2. Rotate the front panel knob to highlight the 'ON' option, then press the [Enter] key to confirm.



Warning!

- O/P Relay set as ON is for special application, it is suggested to set as OFF in general application to protect the equipment.

3. System Information

The screen is for information only. For remote service and diagnostics, the user may be asked to provide some of the information shown here to assist customer service.



4. External Control

The AC source allows the user to make use of a controlling signal from external devices to determine its output. When 'Extern Control' is 'ON', it will enable TTL or ANALOG control input signals, please refer to Section 4.2 "Real Panel Description" on page 18 for detailed information. When 'Analog Volt I/P' is 'ON', it will enable BNC signals input. Analog Volt I/P provides three modes: 'Amplifier', 'Level' and 'Volt Set'.

In 'Amplifier' mode, the output voltage is synthesized by the 'Range' setting on the main interface and amplification of the external control voltage. The external input reference voltage range is -10V~10V. The output Voltage can be calculated using the following formulas (when Vac=0, Vdc=0 on the front panel display).

300V Range: $V_{out}(ac) = V_{ref}(ac)/10 \times 1.414 \text{ Vac} \times 300 \text{ Vac}$
 150V Range: $V_{out}(ac) = V_{ref}(ac)/10 \times 1.414 \text{ Vac} \times 150 \text{ Vac}$

or

300V Range: $V_{out}(dc) = V_{ref}(dc)/10 \text{ Vdc} \times 424.2 \text{ Vdc}$
 150V Range: $V_{out}(dc) = V_{ref}(dc)/10 \text{ Vdc} \times 212.1 \text{ Vdc}$

In 'Level' mode, the output voltage waveform is determined by the selected waveform whose RMS value responds proportionately to the DC input reference voltage with ranging from -10V ~10V. 'Vout' can be calculated using the following formula.

300V Range: $V_{out}(ac) = |V_{ref}(dc)|/10 \text{ Vdc} \times 300 \text{ Vac}$
 150V Range: $V_{out}(ac) = |V_{ref}(dc)|/10 \text{ Vdc} \times 150 \text{ Vac}$

In 'Volt Set' mode, the output voltage responses linearly proportional to the input reference voltage. 'Volt Set' can be set as 3V/5V/10V. For example set Voltage Set as 3V, 'Vout' can be calculated using the following formula:

300V Range: $V_{out}(ac) = V_{ref}(ac)/3 \times 1.414 \text{ Vac} \times 300 \text{ Vac}$
 150V Range: $V_{out}(ac) = V_{ref}(ac)/3 \times 1.414 \text{ Vac} \times 150 \text{ Vac}$

or

300V Range: $V_{out}(dc) = V_{ref}(dc)/3 \text{ Vdc} \times 424.2 \text{ Vdc}$
 150V Range: $V_{out}(dc) = V_{ref}(dc)/3 \text{ Vdc} \times 212.1 \text{ Vdc}$

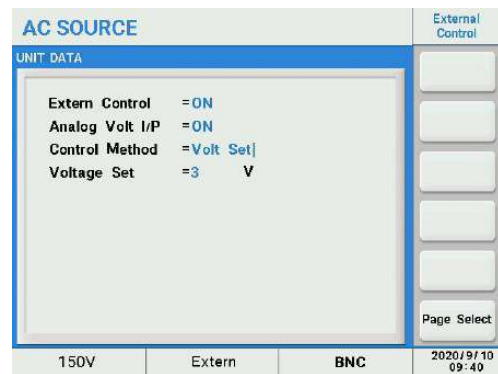
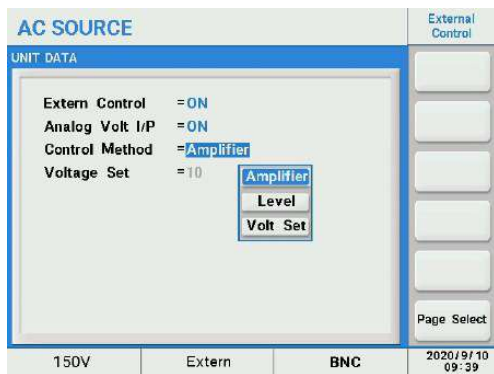

Note

- BNC input has a priority if 'Extern Control' and 'Analog Volt I/O' items set as ON at the same time, but there will be no output if the 'Extern Control' item set as OFF.



Warning!

- If Peak level of the external signal exceeds 10V or the frequency exceeds 1200Hz, damage to the power source may will result.

4.1 Latch Mode

When the latch mode is set to ON, select the corresponding Active Level, which is to enable the Latch function. When the power receives the corresponding external level signal under output state, it will automatically turn off the output and enter the Latch state at the same time; If need to return to normal, the level must be turned over before sending the unlocking instruction. OUTPUT:PROTECTION:CLEAR, After unlocking, the previous output state will be maintained.

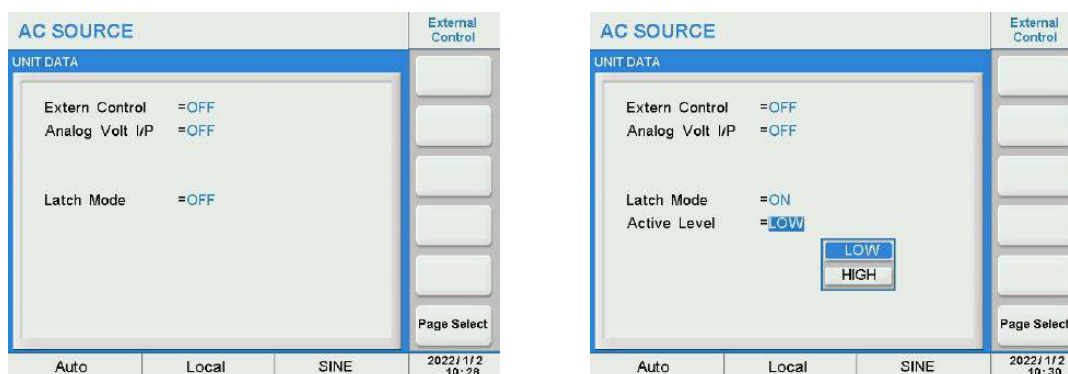

Note

- Because the multiplexed external control KEEP OFF terminal, this function can only be enabled when external control is set to off
- This function setting is saved after power failure; the default low level is valid.
- When the function is turned on, the power will enter into the output latch state if the protection alarm occurs, need to press “Enter” to eliminate the alarm information first, and then send OUTPUT:PROTECTION:CLEAR to unlock the state. Then the power maintain the parameters before the alarm occurs and automatically turn on the output.

5. Protection

This subsection is relevant to user-programmable protection, not internal hardware protection.

‘OPP’ (over power protection): setting range is from 0 through 1.02 times of rated power.

‘OCP’ (over current protection): setting range is from 0 through 1.02 times of rated current.

‘OCPDelay’: setting range is from 0 through 5s.

‘CC (constant current) Mode’: in this mode the output voltage will be automatically decreased to limit the output current when the output current increases too much.

For example, to set the OPP level.

1. In the ‘Protection’ mode screen, move the cursor to highlight ‘OPP=’ field, press [0]~[9] number keys as desired then press the [Enter] key to confirm.
2. Or press the soft key to the right of ‘Set to Maximum’ or ‘Set to Minimum’.

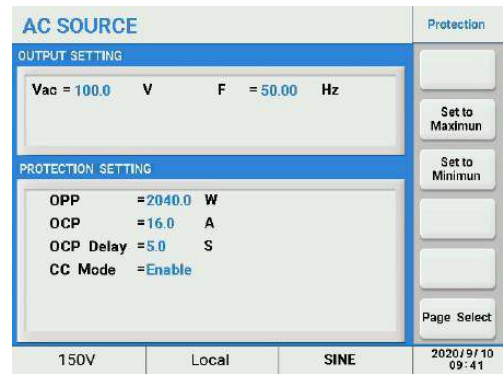
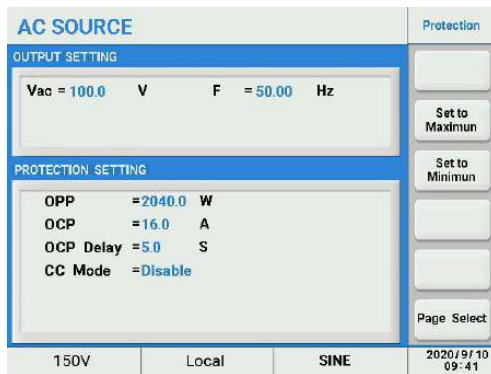

Note

- If the output power is 1~1.1 times of the OPP setting, the output will shut down in about 10s. If the output power greater than 1.1 times of the OPP setting, the output will shut down in about 1.2s.
- If the output current greater than 1.05 times of the OCP setting, the output will shut down in about 500ms. If the output current less than 1.05 times of the OCP setting, the output will shut down in the delay time setting, which range is from 0 through 5s.
- CC Mode response time is approx. 1400ms.

5.2.2.2 LCD Setting

LCD Setting menu includes:

- Display
- Date/Time
- Screen Calibration
- Screen Color Test

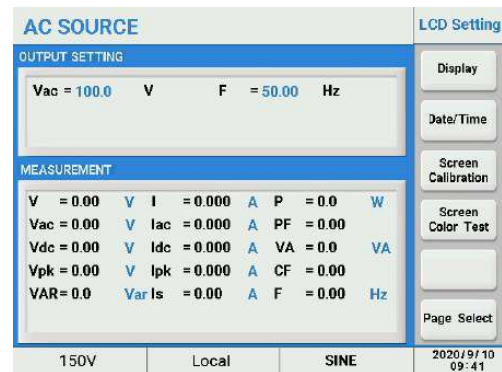

1. Display

The two soft keys in this screen control LCD brightness adjustment for best viewing experience.

1. In the 'Display' screen press the soft key to the right of 'Display' to select brightness adjustment.
2. Then press 'Brightness+' to increase brightness, or 'Brightness-' to decrease the display brightness.

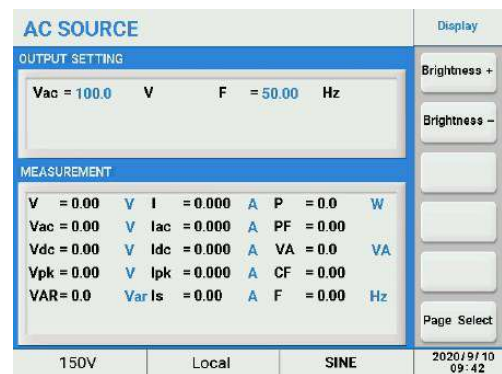

2. Date/Time

The power source has a real-time date and time clock. It is set at the factory at the time of shipment but will have to be adjusted for local date and time zone.

1. In the 'LCD setting' screen, press the soft key to the right of 'Date/Time'.
2. Move the cursor to highlight the item of year, month, day, hour, minute and second then press the [0]~[9] as desired and [Enter] keys to confirm for each selection.



3. Screen Calibration

The touch screen may require period calibration to ensure the on screen fields line up properly with the touch overlay grid.

1. In the 'LCD setting' screen, select the 'Screen Calibration' soft key to display the calibration screen.
2. A calibration cross hair symbol as right will appear. Press the center of the cross hair as best as possible with the stylus. This will complete the touch screen calibration process.

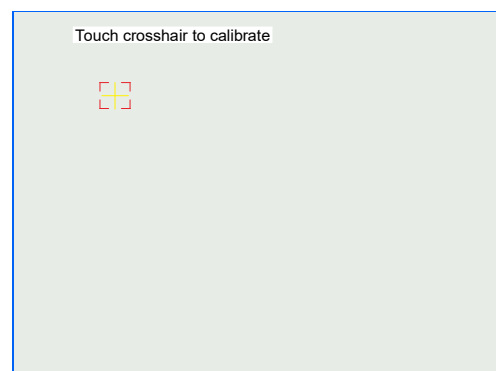

4. Screen Color Test

The screen color test displays a color pattern to check the color correctness of the LCD screen. This is a test only and there are no user adjustments.

5.2.2.3 Calibration

For calibration information, refer to Chapter 7 Calibration.

5.2.2.4 Other Setting

The Other setting screen contains miscellaneous system settings.

The following items can be configured from this screen.

- Recall Default
- Warning Log
- License
- Firmware Update

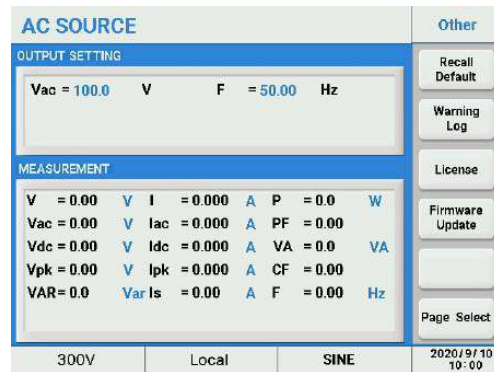

1. Recall Default

The Recall Default screen can be used to recall original factory (default) settings. Doing so will erase the current setup and replace it with default values.

1. Press the soft key to the right side of 'Recall Default'.
2. Press the 'Yes' soft key to restore the factory default setting.

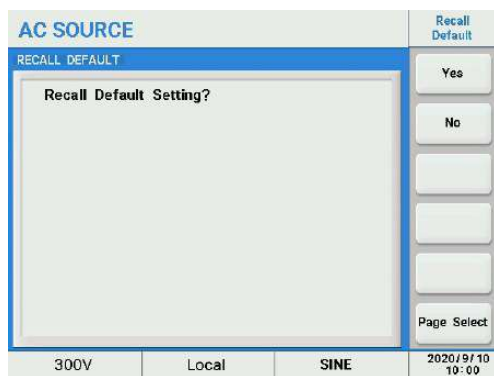

2. Warning Log

The warning log keeps track of any error or warning messages that have been generated by the power since it was last turned on. For each event, the log contains a data stamp, error code and a short description of the event.

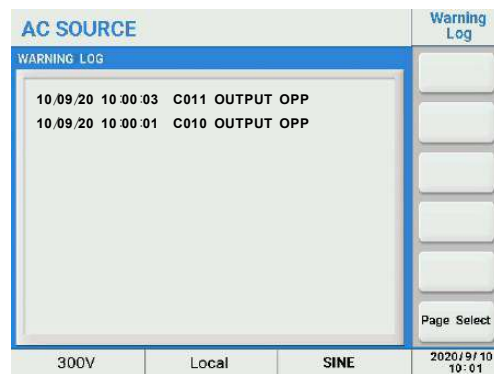

3. License

Displays license information.

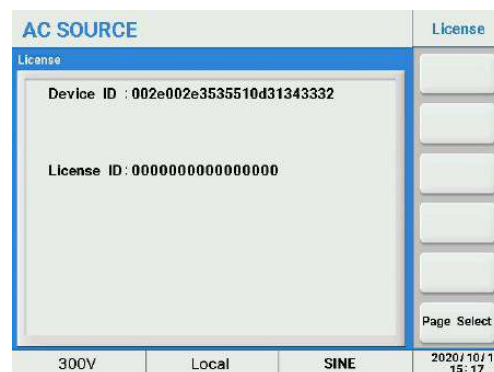

4. Firmware Update

This screen is used to perform a firmware update.

5.2.3 Output Mode

The following items can be configured from this screen.

- PLD Testing
- Harmonics
- IEC Standard
- Special Func
- Test Mode

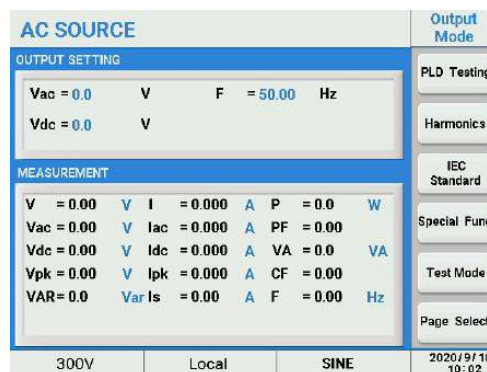

5.2.3.1 PLD Testing

Power Line Distortion testing allows testing of a unit under test for immunity against commonly occurring voltage and or frequency anomalies. The unit supports three transient modes:

- List Mode
- Pulse Mode
- Step Mode



The AC source provides powerful functions to simulate a variety of power line disturbance situations. From the 'Output Mode' screen press the soft key to the right of 'PLD testing' to display the three PLD testing screen.

1. List Mode

This mode includes 50 generically named files. The user can rename and edit all these files. For example, to rename 'List 1' as 'TEST', with 3 steps, repeat 12 times.

1. In the 'PLD testing' screen press the 'List Mode' soft key to program the list file.
2. To rename list 1 for example, rotate the front panel knob to highlight the item 'List 1'.
3. Then press the soft key to the right of 'Rename', rotate and press the front panel knob as appropriate to rename this list. Available characters include A~Z, 0~9 and blank. Then press the [Enter] key to confirm.



4. With the desired List highlighted press the soft key to the right of 'Edit' to edit or create the list file using the parameters shown below.

Vac start, F start, Vdc start = start waveform parameters.

Vac end, F end, Vdc end = end waveform parameters.

Degree= start phase, 0~359.9°

Waveform, A or B can be selected.

Base = Time or Cycle.

Count= Current step repeat count, 0~9999, 0 means infinite loop.

Trigger= Cont (Continuous) or Step, the running mode of the current step.

Repeat the complete list file repeats times, 0~9999, with 0 means infinite loop.

Last Step/Next Step

Step: total number of steps.

Save: to save list file to assigned memory address for quickly recalling at any time. If you do not save the current list file it will be lost after the unit is turned off.

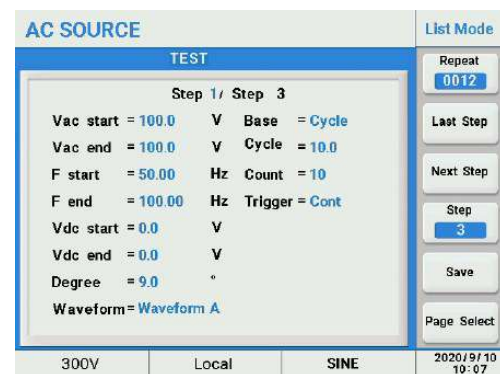
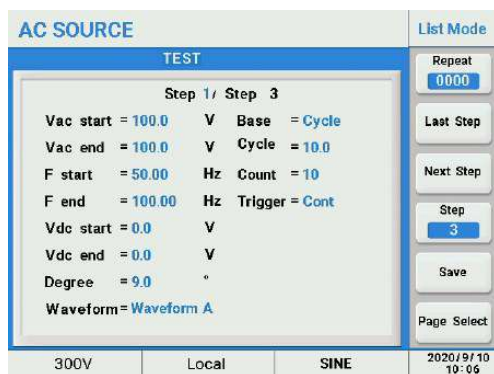

5. Press the [ESC] key to return to the previous screen, press the 'Trigger' soft key to load the settings.
6. Press the 'Trigger' soft key to execute the list file, and the 'Trigger' will change to 'Stop'.

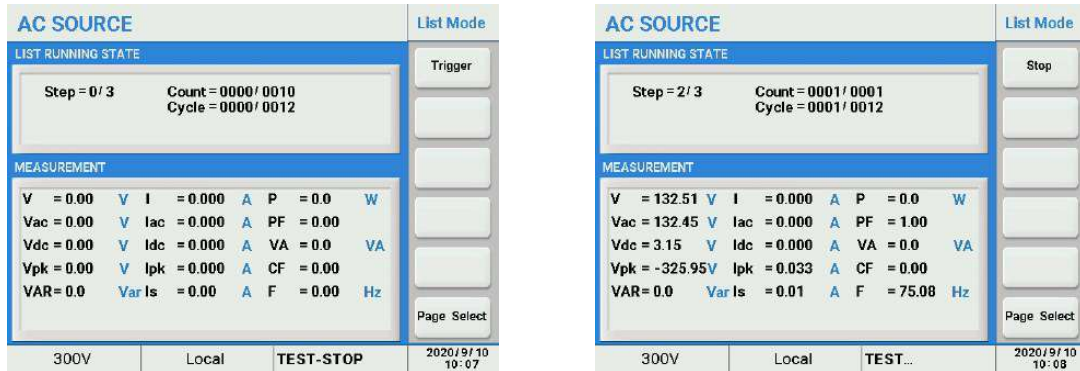

Note

- If you execute the list file with the AC Source 'ON', it will return to the output to the settings of the main screen after the list file execution has completed, or it will turn 'OFF'.
- If the running mode is set as 'Step', the output will remain as the end waveform until the Trigger soft key is touched again.
- The parameters in list files are limited to the limit settings as programmed using the Limitation menu.
- If you stop running the list file, pressing the 'Trigger' soft key again will execute the list file from its beginning when the Trigger is set as 'Cont', or the list file will execute from the current step when 'Trigger' is set as 'Step'.
- The voltage range will be changed to 300V automatically in List mode.

Each list sequence file has total 9 steps, each step is a complete list file. During execution, the running status of the list files is shown in the top part of the display, and the running status of the sequence file is shown in the bottom part.

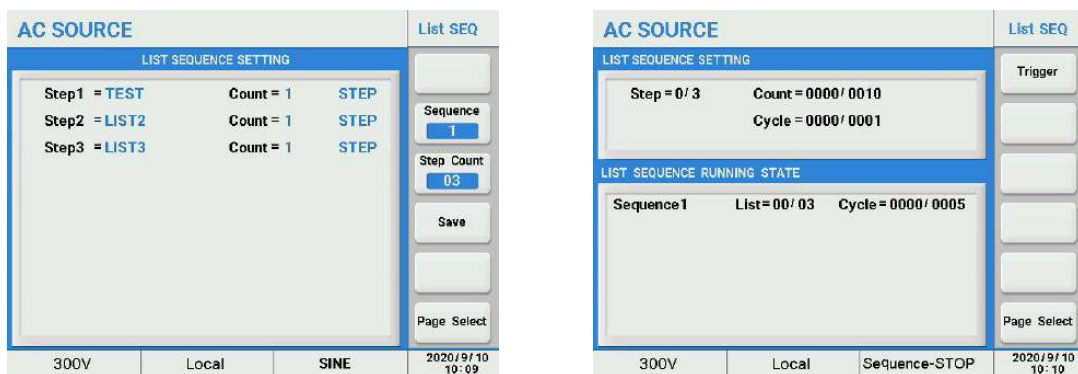

2. Pulse Mode

1. In the 'PLD testing' screen press the 'Pulse Mode' to program the pulse file.
2. Press the soft key to the right of 'Edit'.

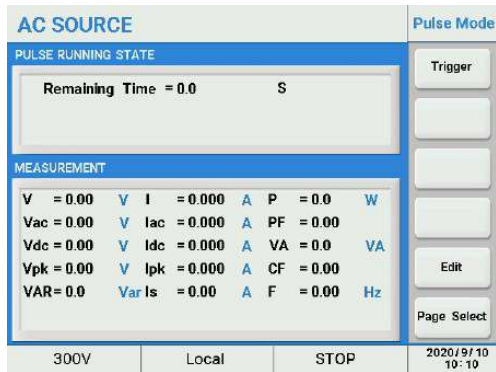

Vac, Vdc, F = pulse setting parameters.

Duty Cycle = duty cycle in % of period at step value.

Degree = start phase, 0~359.9°.

Waveform, A or B can be selected.

Period = duration time of one cycle.

Count = repeat count, 0~9999 with 0 meaning infinite loop.

Start : the time period to hold the present output set values before starting the pulse period(s).

Save : to save the settings to an assigned memory location for quickly recalling at a later time.

If you do not save the current Pulse mode file, it will be lost after the unit is turned off.

3. Press the [ESC] key to return to the previous screen then press the 'Trigger' soft key to load the settings.
4. Press the 'Trigger' soft key to execute the file, and the 'Trigger' will change to 'Stop'. During execution, the remaining period time is shown in the top part of the display. This value updates regularly while the pulse transient is running.

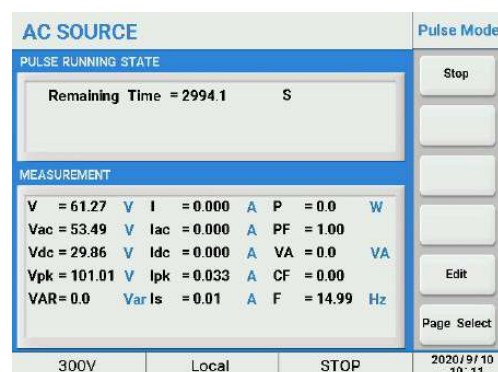
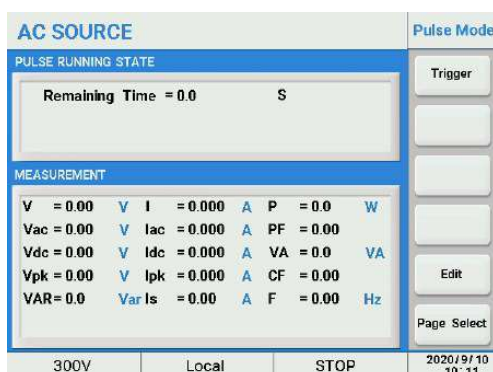

3. Step Mode

1. In the 'PLD testing' screen press the 'Step Mode' soft key.
2. Press the 'Edit' soft key.

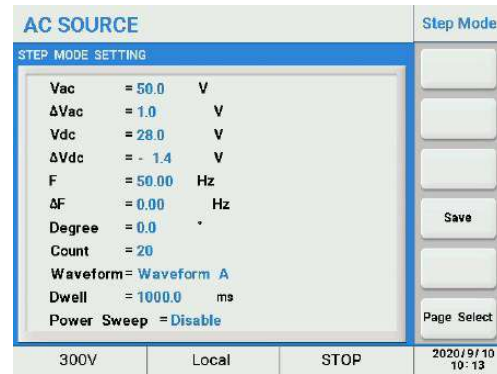
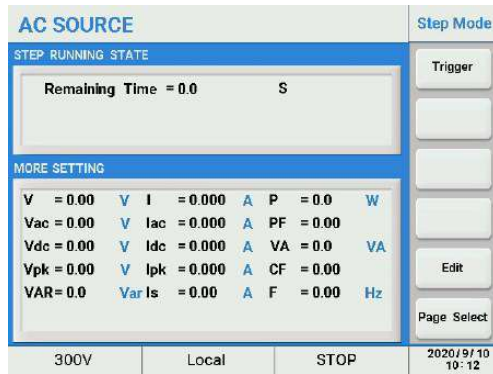

Vac, Vdc, F = step mode start setting.

ΔVac, ΔVdc, ΔF = step value.

Degree = start phase, 0~359.9°.

Count = repeat count, 0~9999 with 0 meaning infinite loop.

Waveform : A or B can be selected.

Dwell : dwell time between steps.

Power Sweep : sweep function.

Save : to save setting to assigned memory room for quickly recall at any time. Do not save the setting, after power off the unit, current file will lose.

3. Press the [ESC] key to return to the previous screen, then press the 'Trigger' soft key to load the settings.
4. Press the 'Trigger' soft key to execute the file, and the 'Trigger' soft key will be changed to 'Stop'. You can press the 'Pause' soft key to temporarily stop the step function or 'Stop' to permanently stop execution of the Step function.

During execution, the remaining time is shown in the top part of the display. This value updates regularly while the step transient is running.

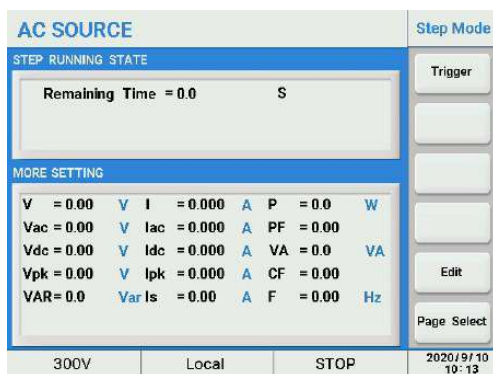

The sweep function is used to test efficiency of power supply and capture the voltage and frequency at the maximum power point. The voltage and frequency of power may be altered in the form of step ladder by setting the start voltage, start frequency, step voltage, step frequency and one-step time. As the test closes, voltage, frequency and current at the maximum power point may be displayed.

5.2.3.2 Harmonics

The Harmonics screen controls the following aspects of harmonic waveform synthesis and measurements:

- Synthesis
- Inter-harmonics
- Harmonic Measure
- User

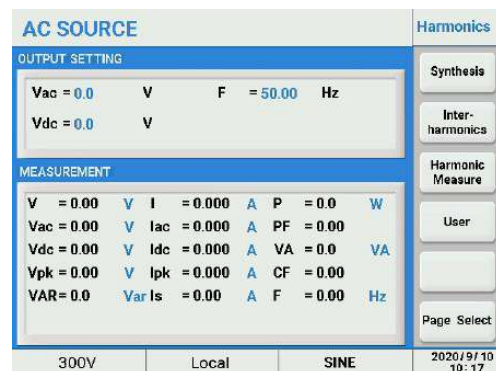

1. Synthesis

The waveform synthesis screen is used to create waveforms made up of a series of harmonic frequencies, amplitudes and phase shifts. Up to 40 order harmonics of 50Hz to 60Hz can be specified.

1. In the 'Harmonics' menu press the 'Synthesis' soft key.
2. Next, press the 'Edit' soft key to set the values of the desired synthesis function.

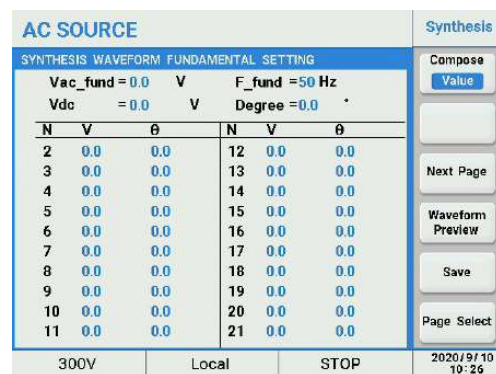
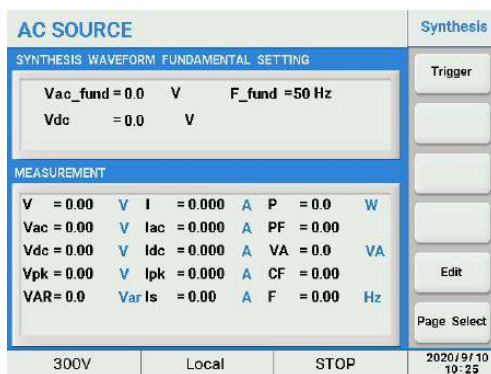

Vac_fund= fundamental voltage.

F_fund= fundamental frequency.

Vdc = DC voltage component.

Degree = start angle, 0~359.9°.

N = Harmonic Number.

V = Harmonic Voltage (Value/Percentage).

θ = phase angle (degrees).

Compose= Value/Percent.

Last Page/Next Page

Waveform Preview : press 'Waveform Preview' soft key to view the waveform shape. Press the [Esc] key to cancel the viewer.

Save : to save Synthesis settings to the assigned memory location for quickly recalling at a later time. If you do not save the current Synthesis settings file, it will be lost after the unit is turned off.

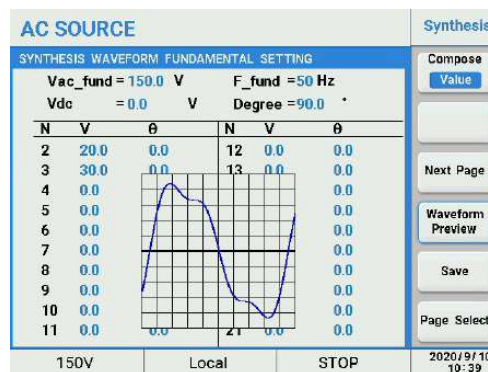
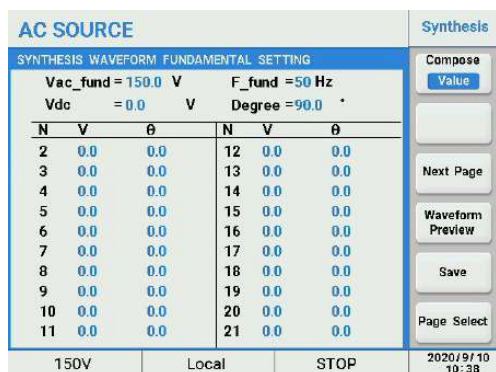

3. Press the [ESC] key to return to the previous screen then press the 'Trigger' soft key to load the settings.

4. Press the 'Trigger' soft key to execute the file, and the 'Trigger' soft key will be changed to 'Stop'.

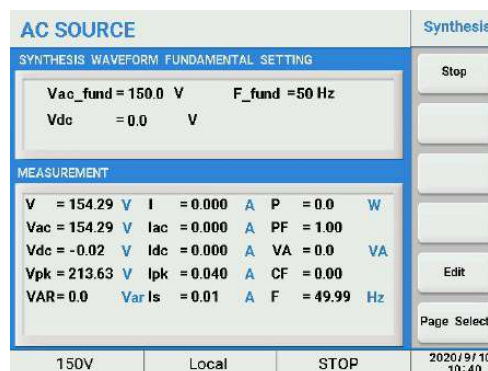
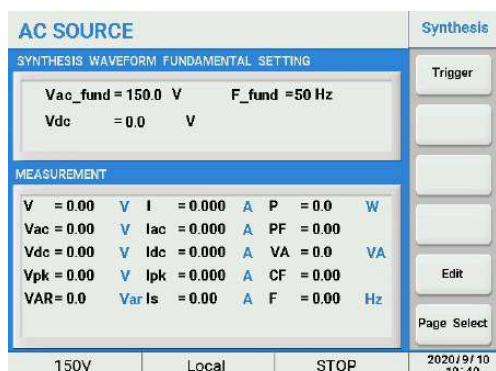

Note

- The following amplitude limitations apply to the synthesized waveform settings:
 - 2 ≤ N ≤ 10, the Value ≤ 150V or the Percent ≤ 100%;
 - 11 ≤ N ≤ 20, the Value ≤ 120V or the Percent ≤ 50%;
 - 21 ≤ N ≤ 30, the Value ≤ 80V or the Percent ≤ 30%;
 - 31 ≤ N ≤ 40, the Value ≤ 45V or the Percent ≤ 15%.
- An OVP error is generated if the output of the synthesized waveform + DC offset exceeds 424Vpk on the 300V range or 212Vpk on the 150V range.

2. Inter-harmonics

Inter-harmonics allow the user to insert a frequency component sweep at the output at a frequency that is not harmonically related to the fundamental frequency. This function is useful for performing immunity tests.

1. Press the 'Inter-harmonics' soft key to display the Inter-Harmonics screens shown below.
2. Press the 'Edit' soft key to set the inter-harmonics parameters.

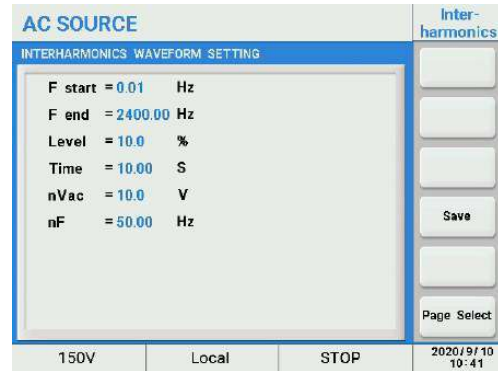
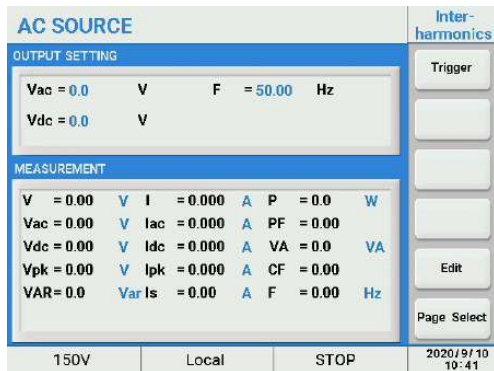

F start= start frequency.

F end= end frequency.

Level= amplitude in % of nVac.

Time = time duration from F start to F end.

nVac = fundamental voltage.

nF = fundamental frequency.

Save: to save Inter-Harmonic settings to the assigned memory location for quickly recalling at a later time. If you do not save the current Inter-Harmonics file, it will be lost after the unit is turned off.

3. Press the [ESC] key to return to the previous screen then press the 'Trigger' soft key to load the settings.
4. Press the 'Trigger' soft key to execute the file, and the 'Trigger' will change to 'Stop'.

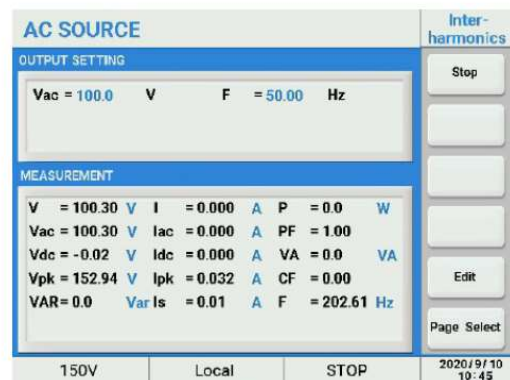
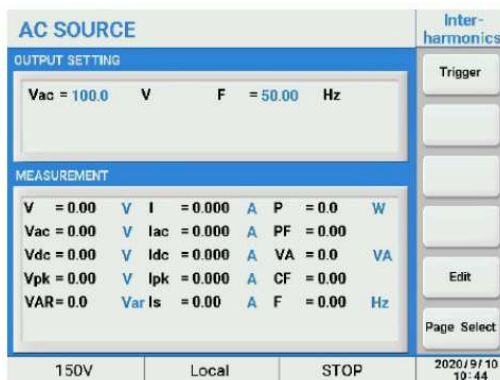

3. Harmonic Measure

The harmonics measurement function measures total harmonic distortion (THD), DC voltage and current and fundamental voltage and current for output setting of 50Hz or 60Hz. Thus, this function is useful for commercial and industrial development and test applications.

1. Press the 'Harmonic Measurement' soft key.
2. Press the 'Edit' soft key, enter the desired source values as follows:

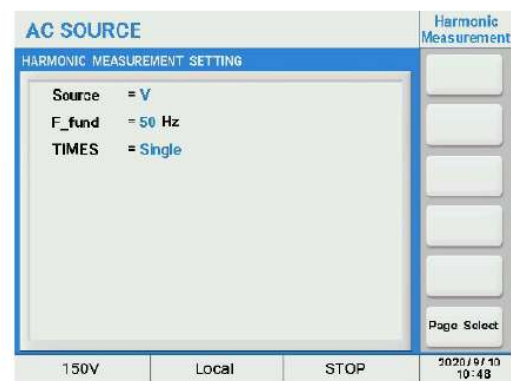
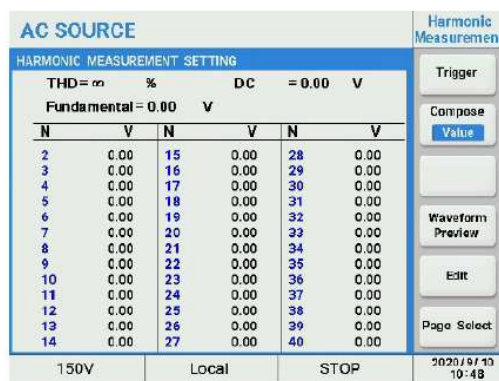

Source : select V or I to measure voltage or current.

F_fund = 50Hz or 60Hz.

TIMES = Single or Continue. Single means one measurement is taken when the 'Trigger' soft key is pressed. Continue means the harmonic measurement runs till the 'Stop' soft key is pressed. Once pressed, it changes to Stop.

3. Press the [ESC] key to return to the previous screen. The measurement is started using the 'Trigger' key.

Compose= Value or Percent

Waveform Preview: previews the graphical representation of the harmonic measurements.

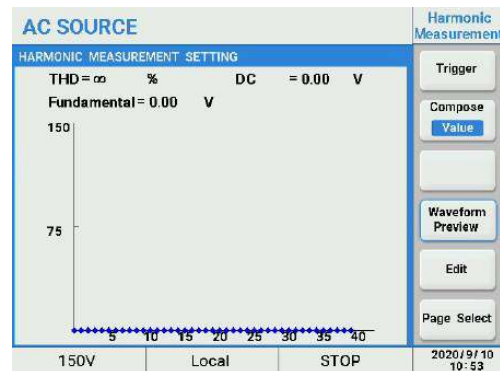
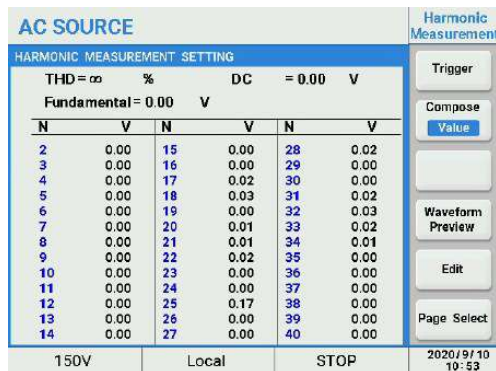

4. Press the 'Trigger' soft key to execute the file, and the 'Trigger' will change to 'Stop'.

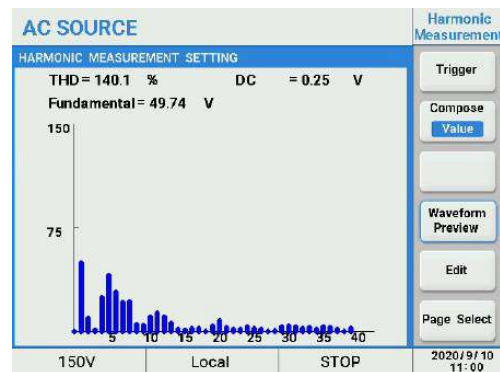
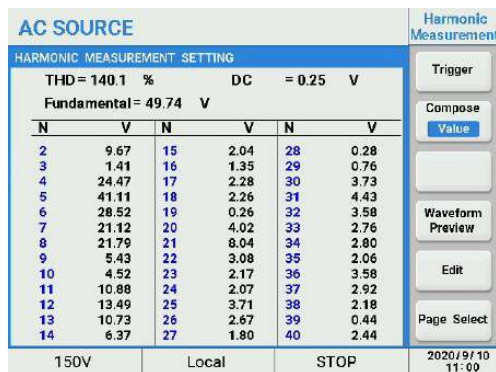

4. User

The User function contains 6 sets of user defined harmonic waveforms, User NO. 0 through User NO. 5.

1. Press the 'User' soft key.
2. Move the cursor to highlight 'User NO. =' field then press the appropriate numeric key and then [Enter] key to confirm. Use the front panel knob to the desired waveform harmonics amplitude %, and phase θ .

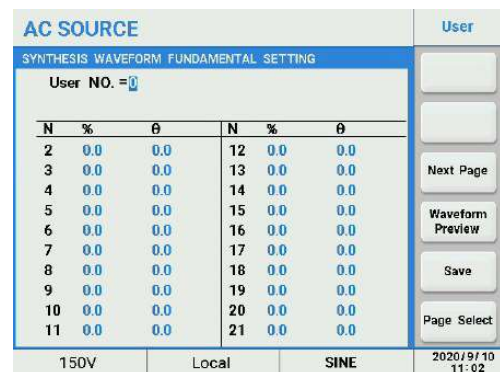
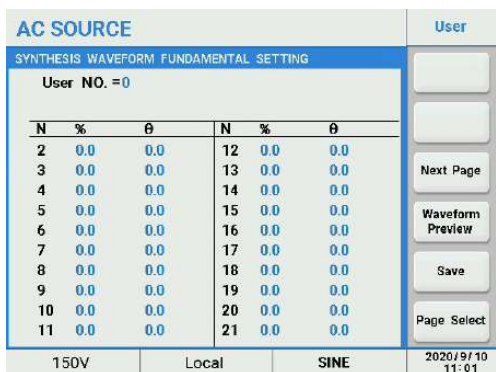

Last Page/Next Page

Waveform Preview: the graphical representation of the waveform.

Save: to save User waveform settings to the assigned memory location for quickly recalling at a later time. If you do not save the current User file, it will be lost after the unit is turned off.

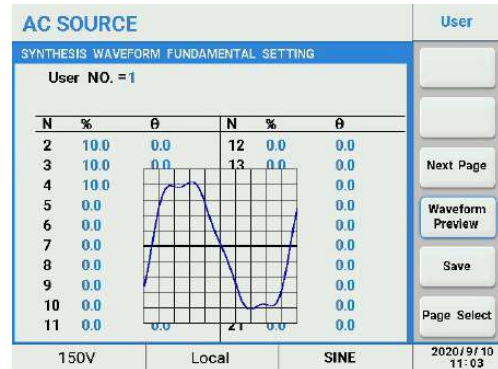
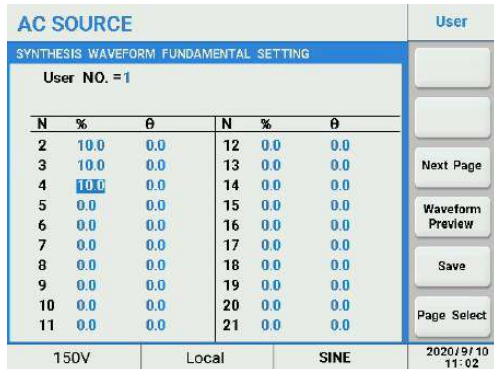

The user can recall the user-defined waveform in Output & More Setting menu.



5.2.3.3 IEC Standard

The IEC61000-4 test function support immunity testing to the following four IEC61000-4 standards:

- IEC4-11
- IEC4-13
- IEC4-14
- IEC4-28

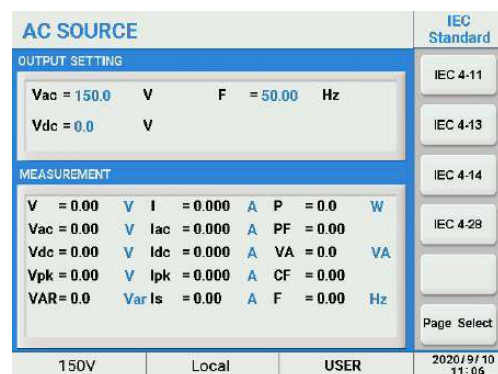

1. IEC4-11

This menu enables users to perform the pre-compliance tests Voltage Dips and Voltage variations against IEC61000-4-11. These test items parameters can also be user-defined.

Voltage Dips Settings

1. In the 'IEC standards' screen press the 'IEC4-11' soft key.
2. Press the 'Voltage Dips' soft key.

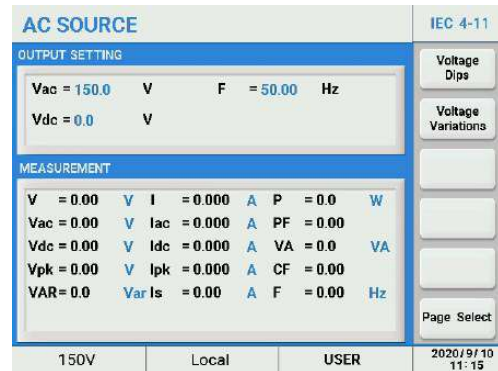
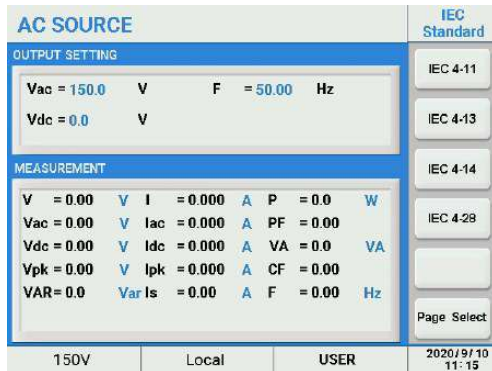

3. Press the 'Edit' soft key.
4. Move the cursor to highlight 'Voltage Dips =' field, then press the [Enter] key to display the drop down list.
5. Rotate the front panel knob to highlight Class 2, then press the [Enter] key to confirm.

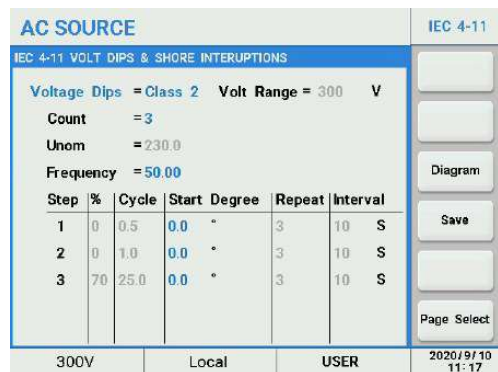
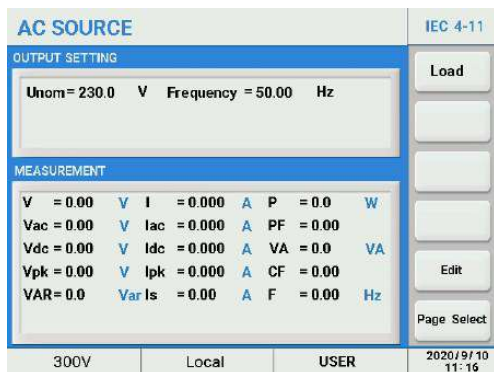

6. Press the numeric keys and [Enter] key to set Count, the available range of which is 0~65535 where 0 means infinite loop.
7. Move the cursor to highlight 'Frequency =' field, then press the [Enter] key to switch between 50 and 60.

Step = test step number.

% = value in % of Unom.

Cycle : the duration of the dip, expressed in cycles.

Start Degree= start angle of the dip, 0~359.9 degrees.

Repeat= the repeat count of the voltage dips.

Interval= time interval between dips.

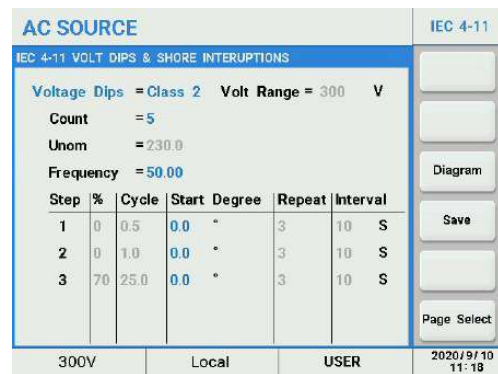
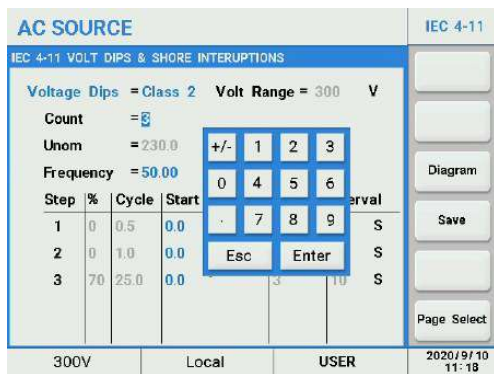

8. Press the 'Diagram' soft key to preview the outline of the test waveform.

9. Press the 'Save' soft key to store the settings in memory.

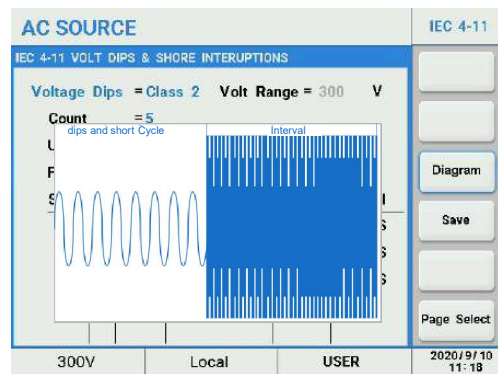

10. Press the [ESC] key to return to the previous screen then press the 'Load' soft key to load the settings.

11. Press the 'Trigger' soft key to execute the file, and the 'Trigger' will change to 'Stop'.

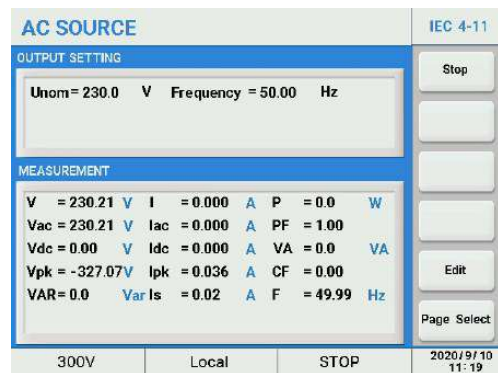
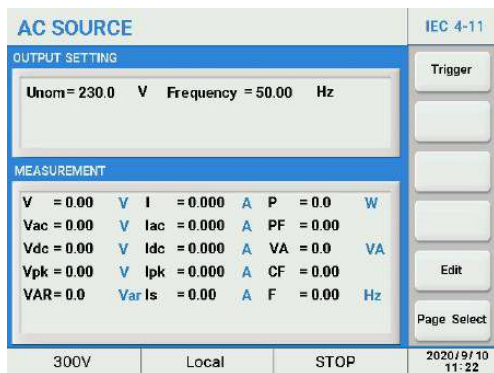

Voltage Variations Settings

1. In the 'IEC standards' screen press the 'IEC4-11' soft key.
2. Press the 'Voltage Variations' soft key.

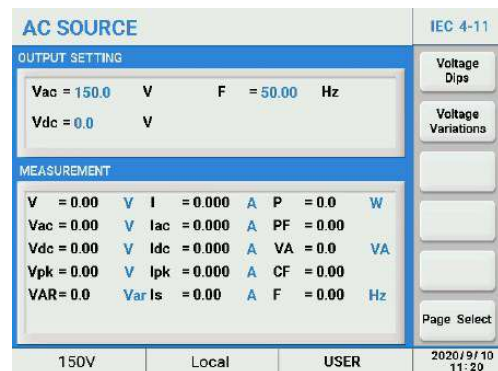
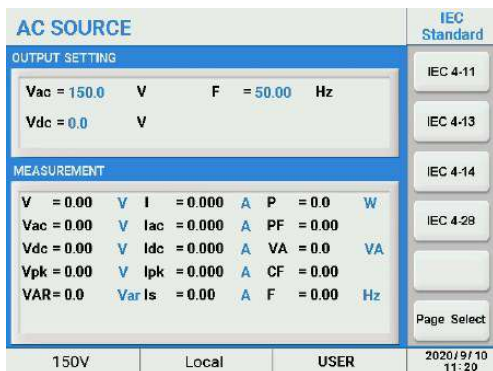

3. Press the 'Edit' soft key.
4. Move the cursor to highlight 'Operation =' field, then press the [Enter] key to switch between **Standard** and **User Def**. If User Def is selected adjust the voltage variation parameters below as desired using the cursor and front panel knob.

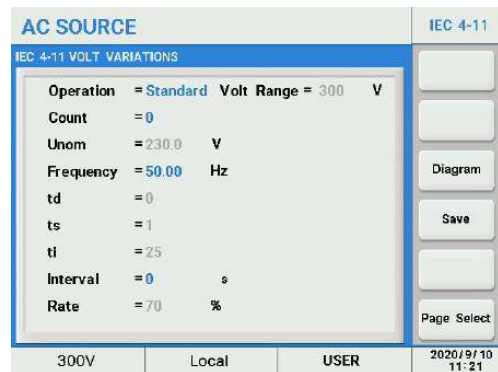
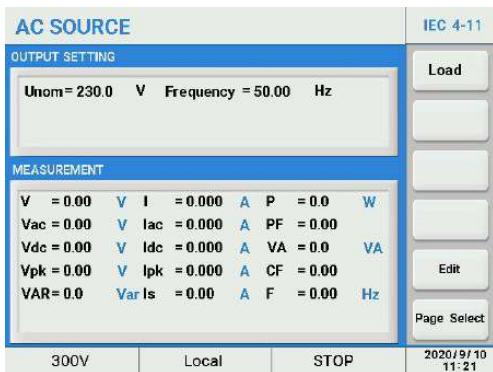

Count= number of repeat cycles. Range is 0~9999. A zero (0) settings means the test runs in an infinite loop.

1 count = Voltage variations + Interval.

Unom : fixed to 230V in Standard mode, can be set as desired in User Def. mode.

Frequency : fixed to 50Hz or 60Hz in Standard mode.

td = fall time for voltage, counted in cycles, fixed to 0 in Standard mode.

ts = duration at variation voltage, counted in cycles, fixed to 1 in Standard mode.

ti = rise time for voltage, counted in cycles.

Interval= duration at Unom after variation is complete.

Rate = variation voltage level in percent of Unom.

5. Press the 'Diagram' soft key to preview the envelope of the test waveform.
6. Press the 'Save' soft key to store the settings in non-volatile memory.

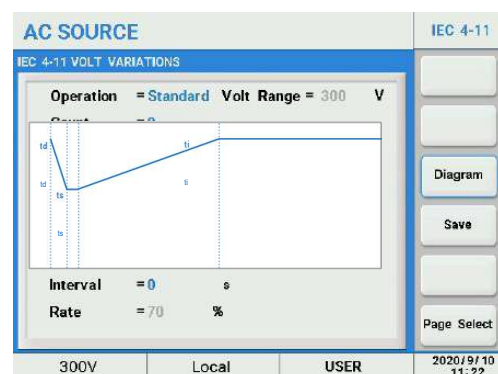

7. Press the [ESC] key to return to the previous screen then press the 'Load' soft key to load the settings.
8. Press the 'Trigger' soft key to execute the file, and the 'Trigger' will change to 'Stop'.

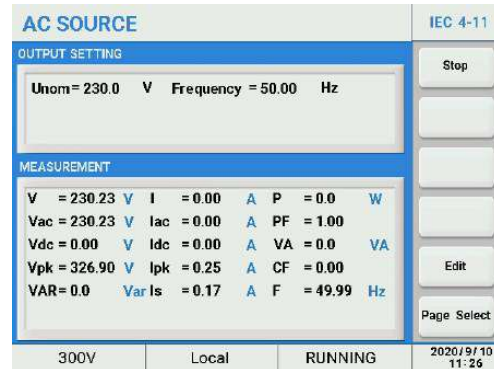
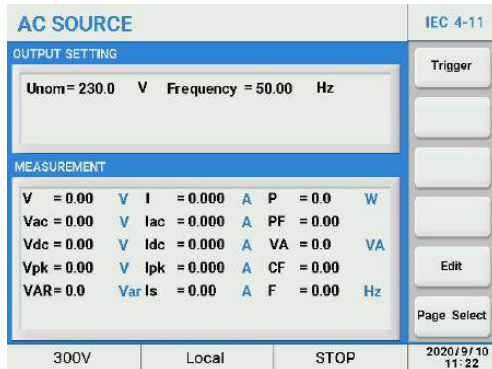

At the completion of the entire sequence, the 'Stop' soft key will revert to 'Trigger'. To abort a test in progress, press the 'Stop' soft key during a test run.

2. IEC4-13

This menu enables users to perform the pre-compliance tests Flat Curve and Over Swing according to standard IEC61000-4-13. The test items parameters also can be user-defined.

Flat Curve Setting

1. In the 'IECstandards' screen press the 'IEC4-13' soft key.
2. Press the 'Flat Curve' soft key.

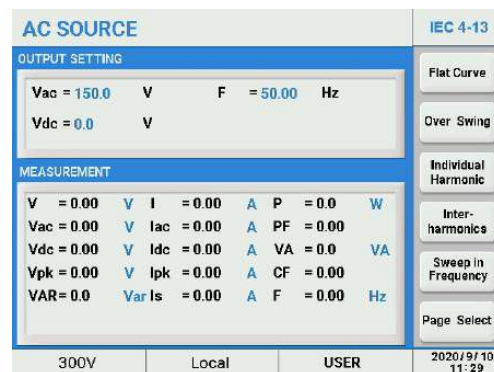
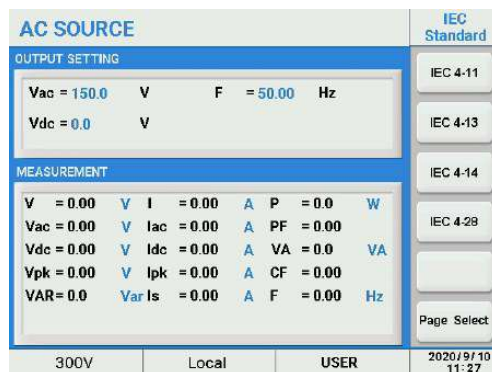

3. Press the 'Edit' soft key.
4. Move the cursor to highlight 'Test Level =' field, then press the [Enter] key to display the drop down list.
5. Rotate the front panel knob to highlight 'Class 1' and then press the [Enter] key to confirm. Adjust the parameters below if it is desired for them to be different from the default IEC4-13 values.

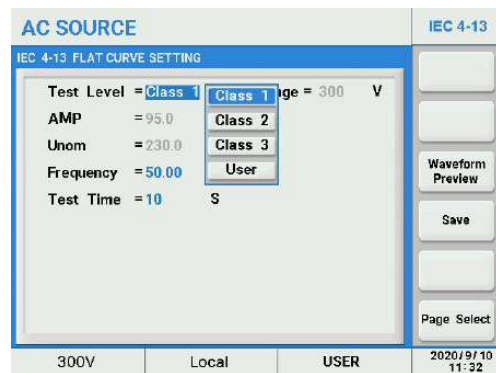
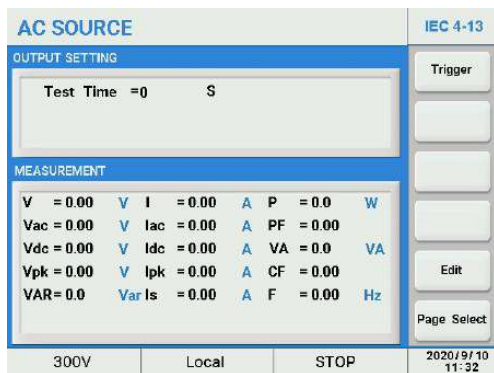

AMP = voltage amplitude in percent of nominal voltage. Fixed at 100% in standard modes.
Unom = nominal test voltage. Fixed at 230V in standard mode, but can be set in User mode.
Frequency = fixed at 50Hz or 60Hz in standard modes.
Test Time = Duration of test.

6. Press the 'Waveform Preview' soft key to see a visual representation of the test waveform. Press again to clear the preview.
7. Press the 'Save' soft key to store the test setting in non-volatile memory.

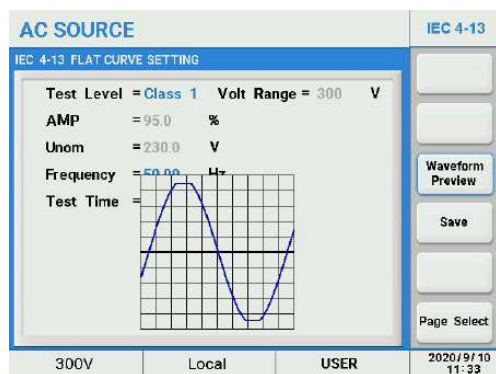

8. Press the [ESC] key to return to the previous screen then press the 'Trigger' soft key to load the settings.
9. Press the 'Trigger' soft key to execute the file, and the 'Trigger' will change to 'Stop'.

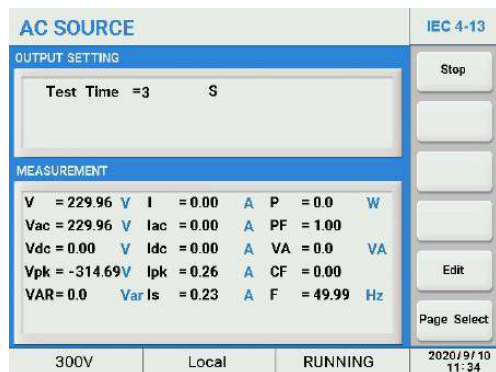
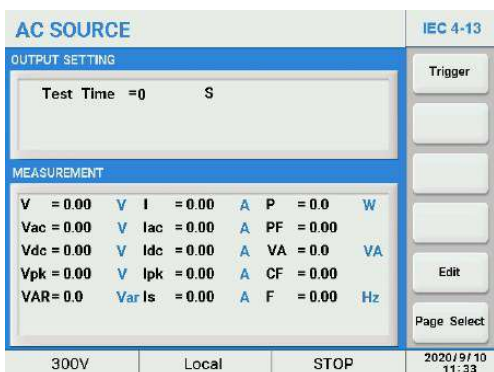

Over Swing Setting

1. In the 'IEC standards' screen press the 'IEC4-13' soft key.
2. Press the 'Over Swing' soft key.

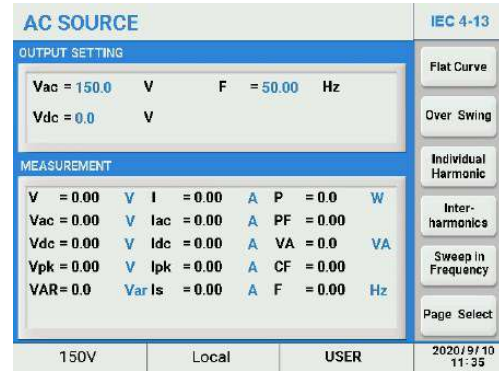
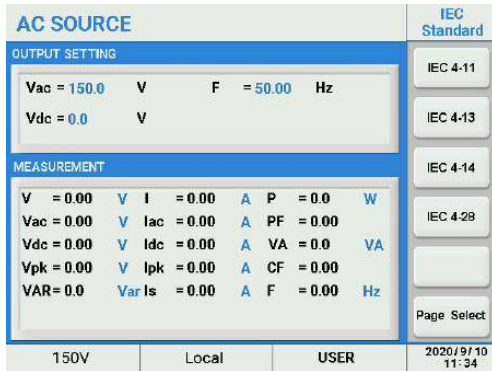

3. Press the 'Edit' soft key.
4. Move the cursor to highlight 'Test Level =' field, then press the [Enter] key to display the drop down list.
5. Rotate the front panel knob to highlight 'Class 1' then press the [Enter] key to confirm.

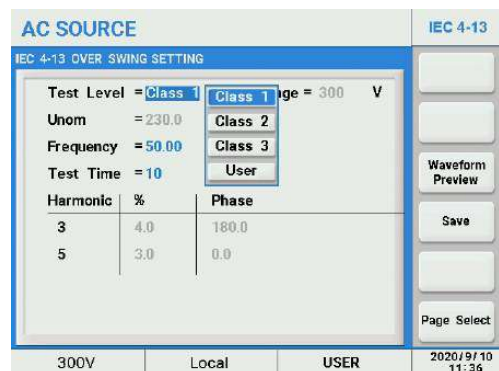
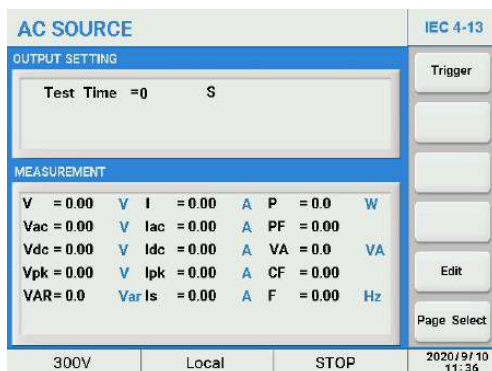

- Unom**= nominal test voltage. Fixed at 230V in standard modes.
- Frequency**= 50Hz or 60Hz in standard modes.
- Test Time** = duration of the test in seconds.
- Harmonics, %** = amplitude in percent for 3rd and 5th harmonics.
- Harmonics Phase** = phase shift of third and fifth harmonics.

6. Press the 'Waveform Preview' soft key to see a visual representation of the test waveform. Press again to clear the preview.
7. Press the 'Save' soft key to store the test setting in non-volatile memory.

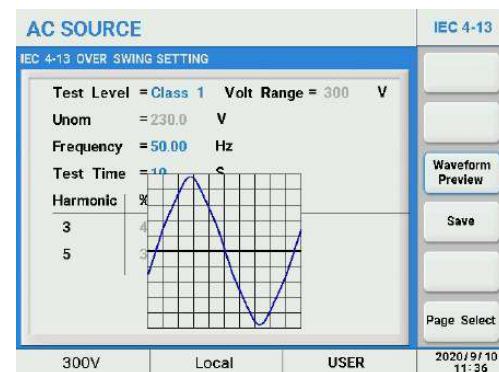

8. Press the [ESC] key to return to the previous screen then press the 'Trigger' soft key to load the settings.
9. Press the 'Trigger' soft key to apply the test to the unit under test. Once pressed, it changes to 'Stop'.

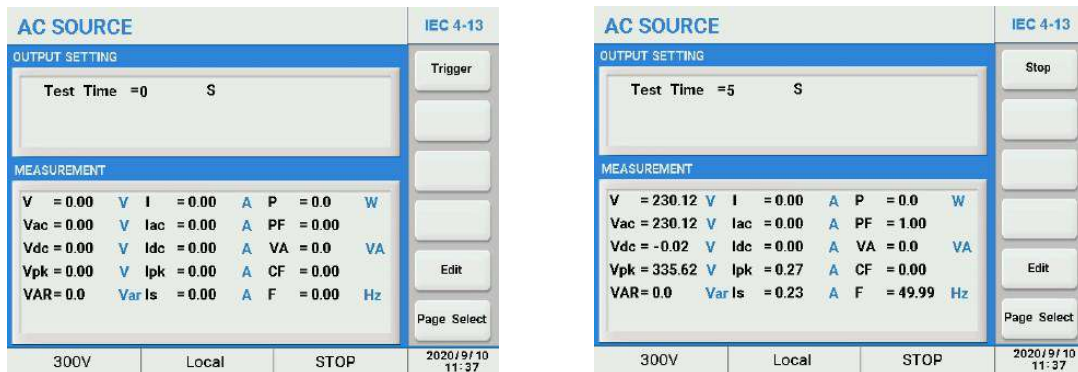

The test time now run until completed. Total test time is determined by the Test Time setting. The test time count down in seconds is visible in the upper part of the IEC4-13 screen. At the completion of the test, the 'Stop' soft key will revert to 'Trigger'. To abort a test in progress, press the 'Stop' soft key during a test run.

Individual Harmonics Setting

1. In the 'IEC standards' screen press the 'IEC4-13' soft key.
2. Press the 'Individual Harmonic' soft key to display the Individual Harmonics test screen.

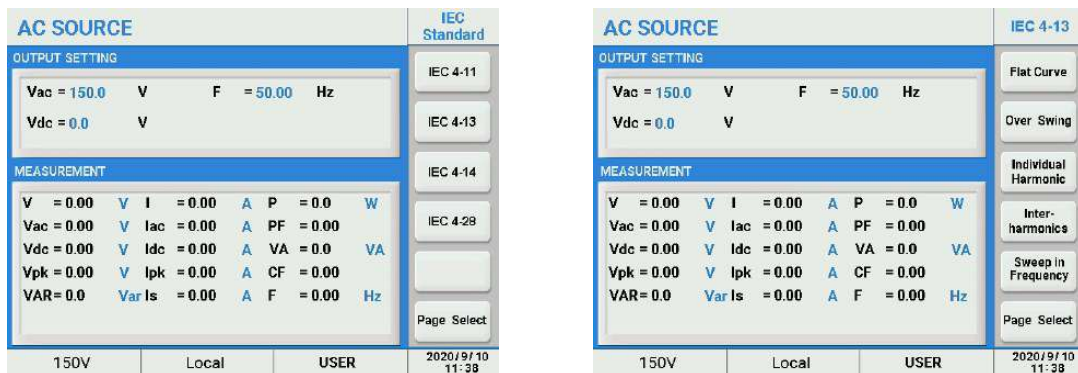

3. Press the 'Edit' soft key to set the required test selections for this test.
4. Move the cursor to highlight 'Class =' field, then press the [Enter] key to display the drop down list.
5. Rotate the front panel knob to highlight 'non-multiple of 3' and press the [Enter] key to confirm.

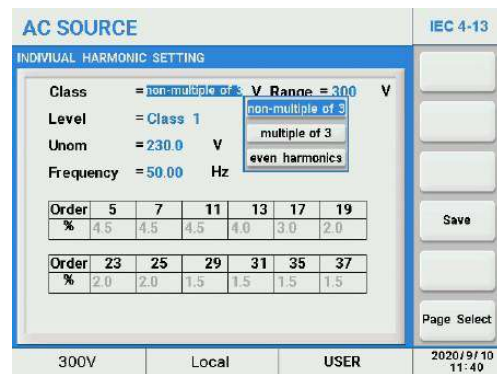
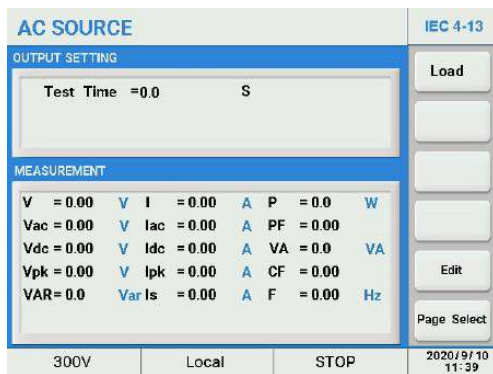

6. Move the cursor to highlight 'Level =' field, then press the [Enter] key to display the drop down List.
7. Rotate the front panel knob to highlight 'Class 2' and press the [Enter] key to confirm.

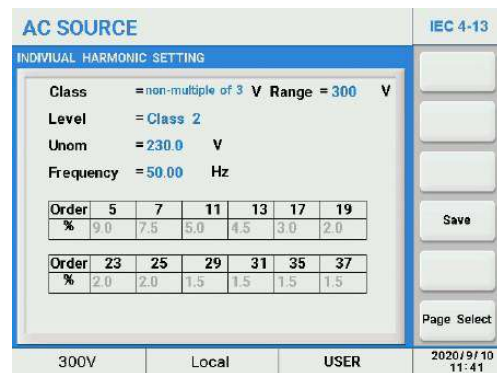
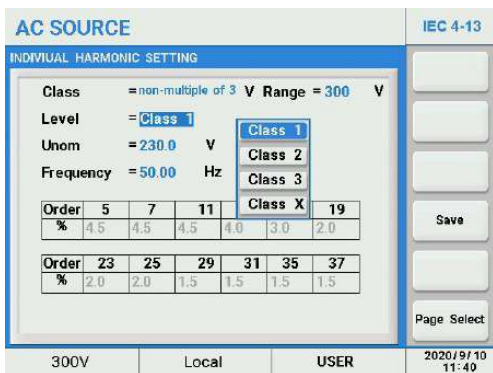

8. Press the 'Save' soft key to store the test setting in non-volatile memory.
9. Press the [ESC] key to return to the previous screen then press the 'Load' soft key to load the settings.
10. Press the 'Trigger' soft key to execute the file. Once pressed, it changes to 'Stop'.

The test time now run until completed. Total test time is determined by the Class and Level settings.

The test time count down in seconds is visible in the upper part of the IEC4-13 screen.

At the completion of the test, the 'Stop' soft key will revert to 'Trigger'. To abort a test in progress, press the 'Stop' soft key during a test run.

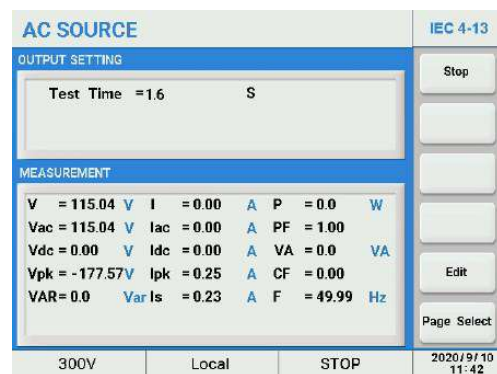
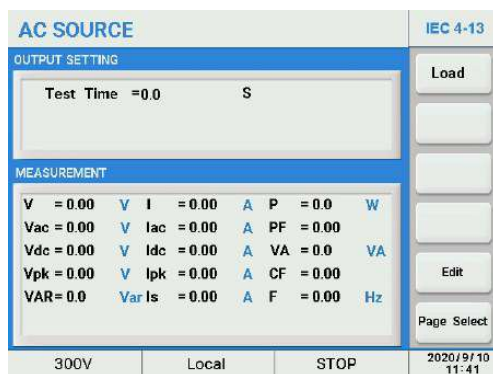

Inter-harmonics Setting

1. In the 'IEC standards' screen press the 'IEC4-13' soft key.
2. Press the 'Inter-harmonics' soft key to display the Inter-harmonics test screen.

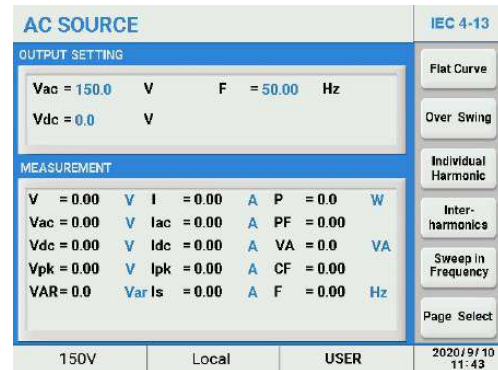
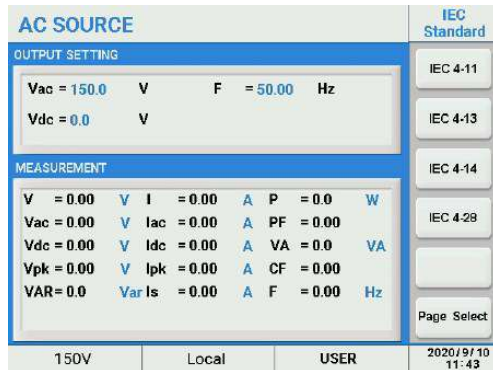

3. Press the 'Edit' soft key to set the required test selections for this test.
4. Move the cursor to highlight 'Level=' field and press the [Enter] key to display a drop down list with product class selections.
5. Rotate the front panel knob to highlight Class 3 and press the [Enter] key to confirm.

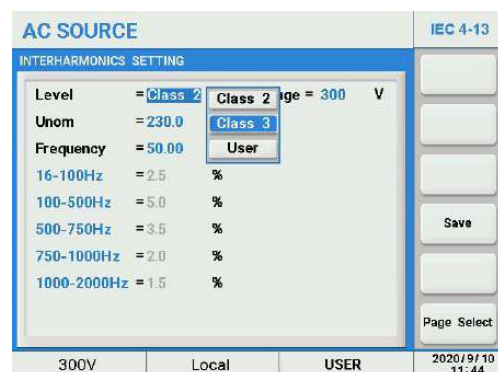
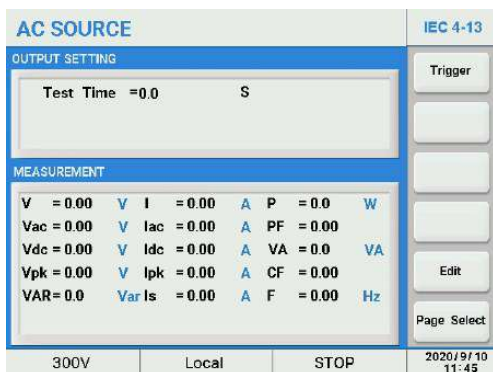

Unom : Nominal test voltage, fixed to 230V in standard modes.

Frequency : 50Hz or 60Hz in standard modes.

Test Levels in % of Unom for Inter-Harmonics ranges:

Default test levels, % Unom, for 50Hz mains.

- 0.33*f1 to 2*f1, 16~100 Hz, 2.5%;
- 2*f1 to 10*f1, 100~500 Hz, 5.0%;
- 10*f1 to 15*f1, 500~750 Hz, 3.5%;
- 15*f1 to 20*f1, 750~1000 Hz, 2.0%;
- 20*f1 to 40*f1, 1000~2000 Hz, 1.5%;

6. Press the 'Save' soft key to store the settings in non-volatile memory.
7. Press the 'Trigger' soft key to execute the file. Once pressed, it changes to 'Stop'.

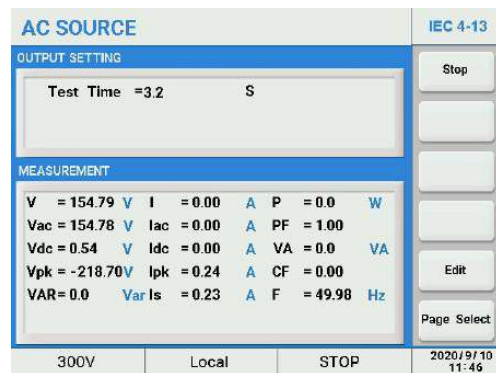
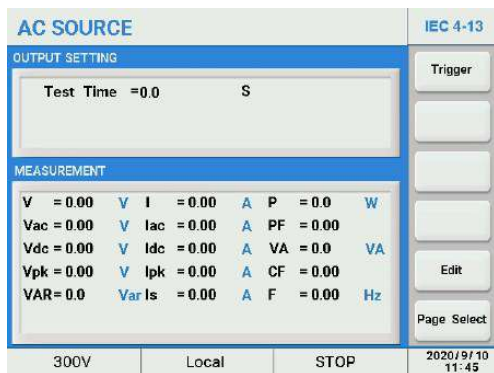

The test time now run until completed. Total test time is determined by the test Level settings. The test time count down in seconds is visible in the upper part of the IEC4-13 screen. At the completion of the test, the 'Stop' soft key will revert to 'Trigger'. To abort a test in progress, press the 'Stop' soft key during a test run.

Sweep in Frequency Setting

1. In the 'IEC standards' screen press the 'IEC4-13' soft key.
2. Press the 'Sweep in Frequency' soft key to display the test screen.

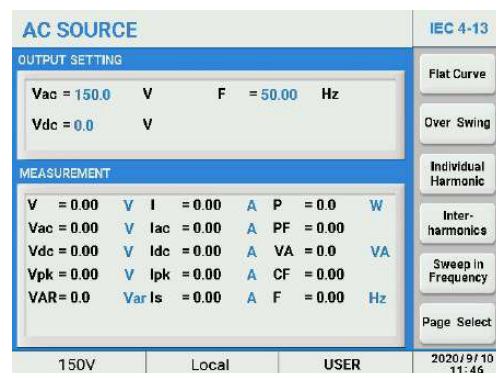
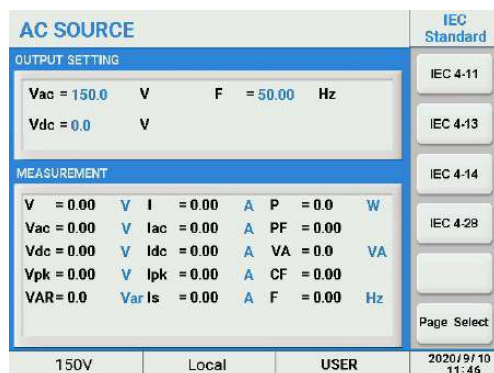

3. Press the 'Edit' soft key to set the required test selections for this test.
4. Move the cursor to highlight the 'Level =' field and press the [Enter] key to display a drop down list with product class selections.
5. Rotate the front panel knob to highlight 'Class 1' and then press the [Enter] key to confirm.

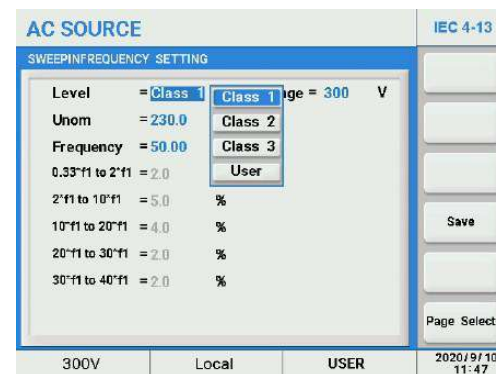
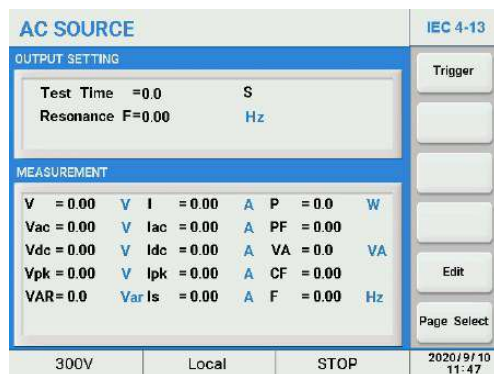

Unom : Nominal test voltage, fixed to 230V in standard modes.

Frequency : 50Hz or 60Hz in standard modes.

Test Levels in % of Unom for Inter-Harmonics ranges:

Default test levels, % Unom, for 50Hz mains.

0.33*f1 to 2*f1, 16~100 Hz, 2.0%;

2*f1 to 10*f1, 100~500 Hz, 5.0%;

10*f1 to 20*f1, 500~1000 Hz, 4.0%;

20*f1 to 30*f1, 1000~1500 Hz, 2.0%;

30*f1 to 40*f1, 1500~2000 Hz, 2.0%;

6. Press the 'Save' soft key to store the settings in non-volatile memory.

7. Press the [ESC] key to return to the previous screen, press the 'Trigger' soft key to load the settings.

8. The resonance frequency will be displayed on the screen after the test has finished.

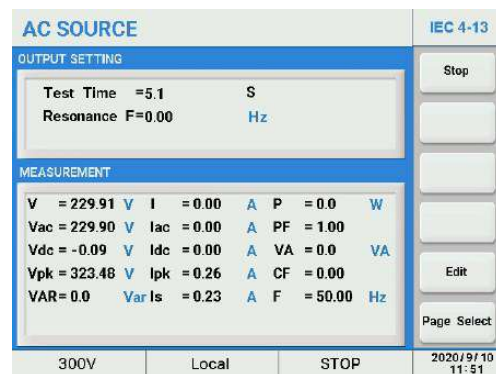
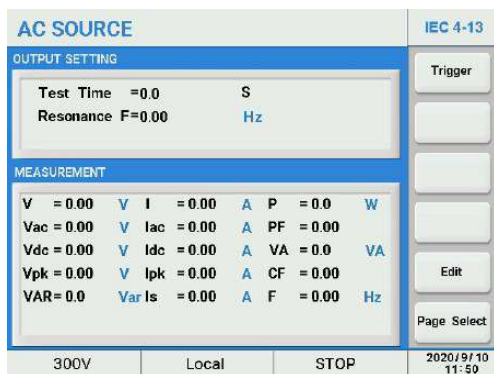

The test time now run until completed. Total test time is determined by the test Level settings.

The test time count down in seconds is visible in the upper part of the IEC 4-13 screen.

At the completion of the test, the 'Stop' soft key will revert to 'Trigger'. To abort a test in progress, press the 'Stop' soft key during a test run.

Meister Curve Setting

1. In the 'IEC standards' screen Press the 'IEC4-13' soft key.

2. Press the 'Sweep in Frequency' soft key.

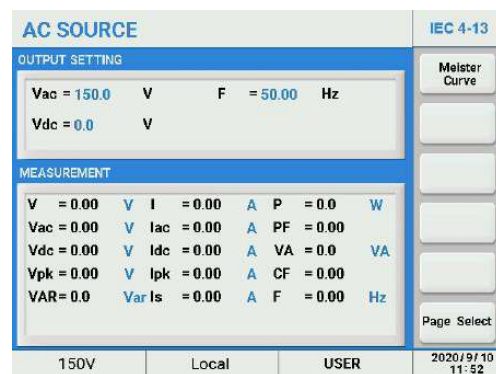

3. Press the 'Edit' soft key.
4. Move the cursor to highlight 'Level =' field, then press the [Enter] key to display the drop down list.
5. Rotate the front panel knob to highlight 'Class 2' then press the [Enter] key to confirm.

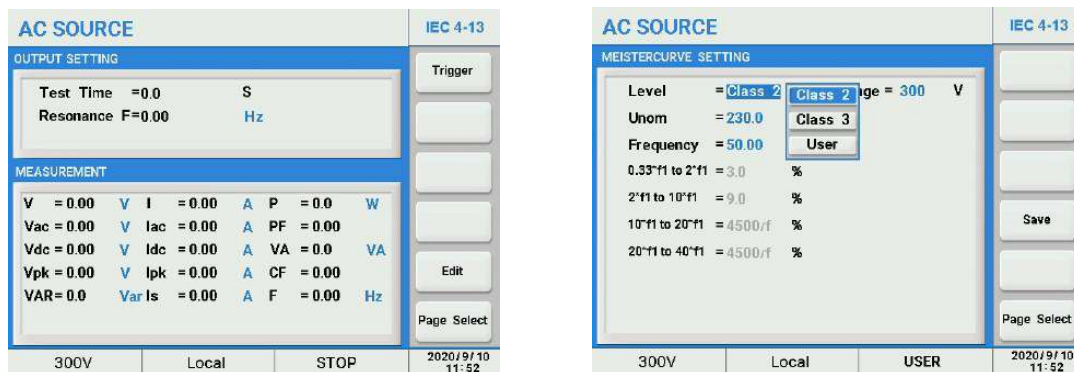

Unom : Nominal test voltage, fixed to 230V in standard modes.

Frequency : 50Hz or 60Hz in standard modes.

Test Levels in % of Unom for Inter-Harmonics ranges:

Default test levels : % Unom, for 50Hz mains.

0.33*f1 to 2*f1, 16~100 Hz, 3.0%;

2*f1 to 10*f1, 100~500 Hz, 9.0%;

10*f1 to 20*f1, 500~1000 Hz, 4500/f% ;

20*f1 to 40*f1, 1000~1500 Hz, 4500/f% ;

6. Press the 'Save' soft key to store the settings in non-volatile memory.
7. Press the [ESC] key to return to the previous screen, press the 'Trigger' soft key to load the settings.
8. The resonance frequency will be displayed on the screen after the testing has finished.

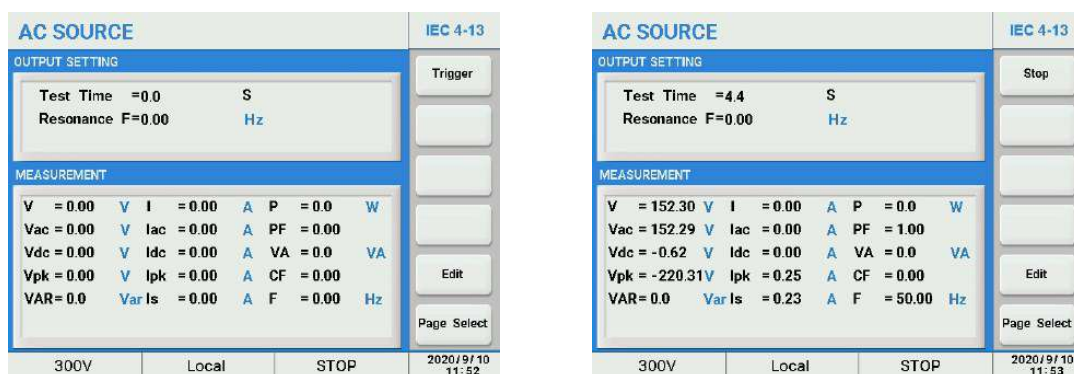

The test time now run until completed. Total test time is determined by the test Level settings.

The test time count down in seconds is visible in the upper part of the IEC4-13 screen.

At the completion of the test, the 'Stop' soft key will revert to 'Trigger'. To abort a test in progress, press the 'Stop' soft key during a test run.

3. IEC4-14

This menu allows users to perform the pre-compliance test Voltage Fluctuation Immunity according to IEC61000-4-14. The test item parameters also can be user-defined.

1. In the 'IECstandards' screen press the 'IEC4-14' soft key.
2. Press the 'Edit' soft key to set the required test selections for this test.

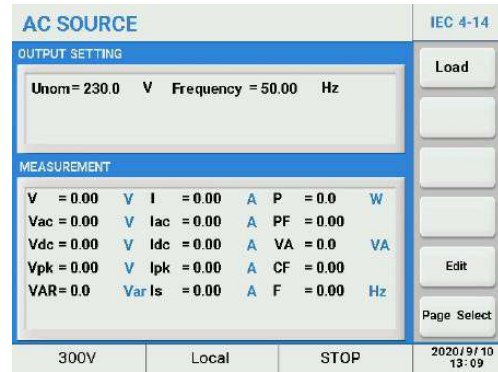
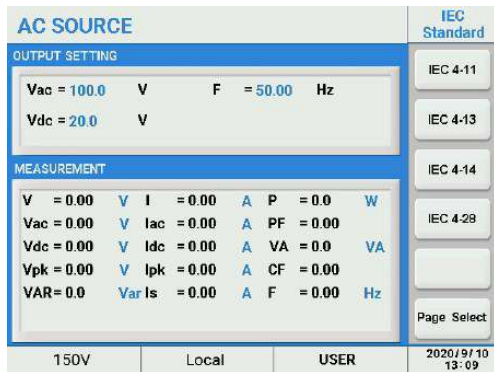

3. Move the cursor to highlight 'Operation =' field, then press the [Enter] key to switch between Standard and User Def.
4. Move the cursor to highlight 'Class =' field, then press the [Enter] key to display the drop down list, rotate the front panel knob to highlight 'Class 2' then press the [Enter] key to confirm.

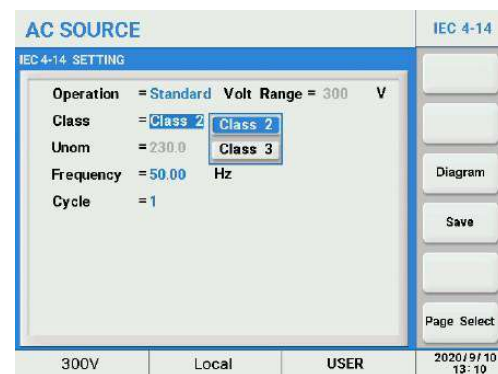
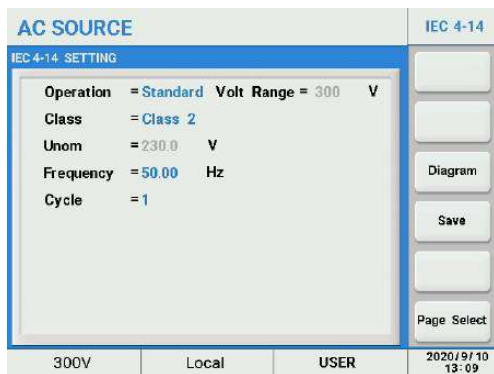

Unom= Nominal test voltage. Fixed at 230V in Standard modes, but can be set as desired in User Def. mode.

Frequency= 50Hz or 60Hz in standard modes, but can be set in User Def. mode.

Cycle= number of test cycles, which range is 0~9999, 0 means infinite loop.

5. Press the 'Diagram' soft key to see a visual representation of the test waveform. Press again to clear the preview.
6. Press the 'Save' soft key to store the test setting in non-volatile memory.

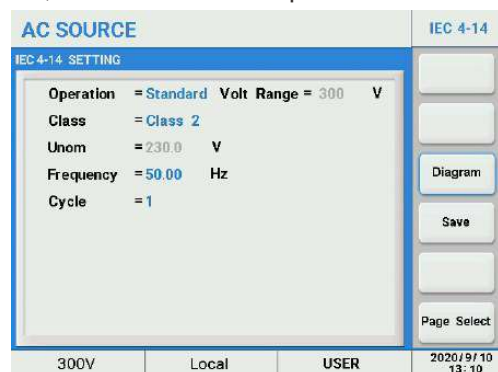

- Press the [ESC] key to return to the previous screen then press the 'Trigger' soft key to load the settings.
- Press the 'Trigger' soft key to apply the test to the unit under test. Once pressed, it changes to 'Stop'.

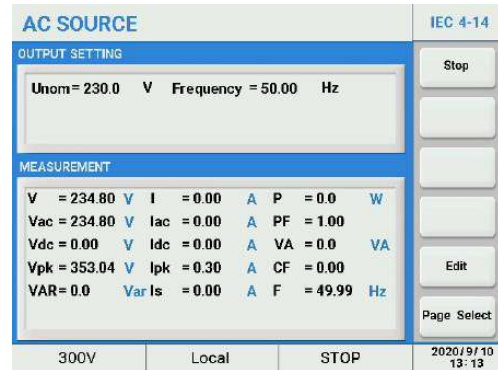
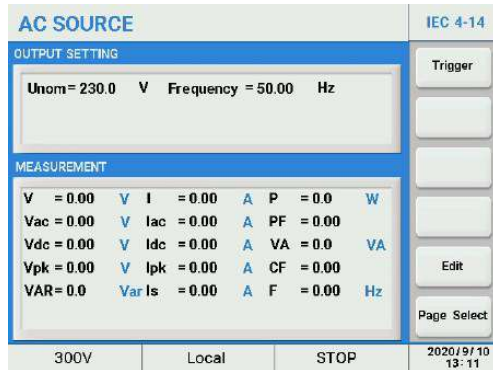

At the completion of the test, the 'Stop' soft key will revert to 'Trigger'. To abort a test in progress, press the 'Stop' soft key during a test run.

4. IEC4-28

This menu enables users to perform the pre-compliance test Variation of Power Frequency Immunity Test against IEC61000-4-28. The test item parameters also can be user-defined.

- In the 'IEC standards' screen press the soft key to the right of 'IEC4-28'.
- Press the soft key to the right of 'Edit'.

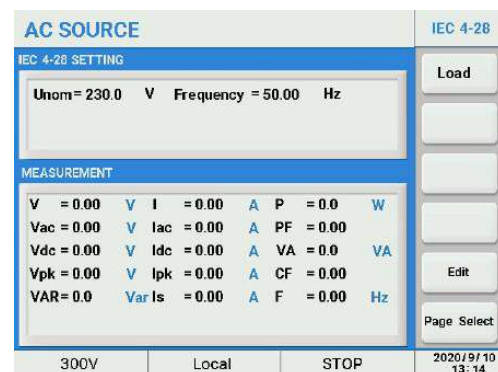
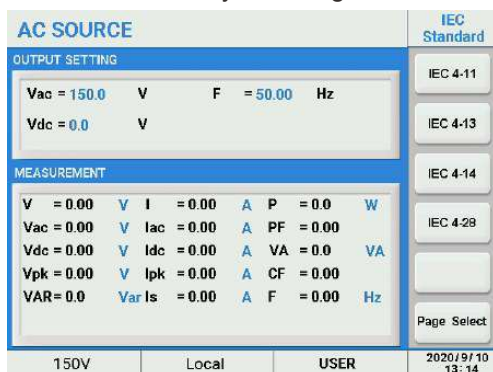

- Move the cursor to highlight the 'Operation=' field and press the [Enter] key to switch between Standard and User Defined.
- Move the cursor to highlight the 'Test Level=' field then press the [Enter] key to display the drop down list, rotate the front panel knob to highlight 'Level 2' and press the [Enter] key to confirm.

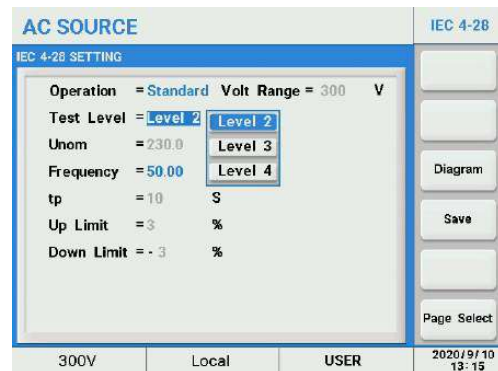
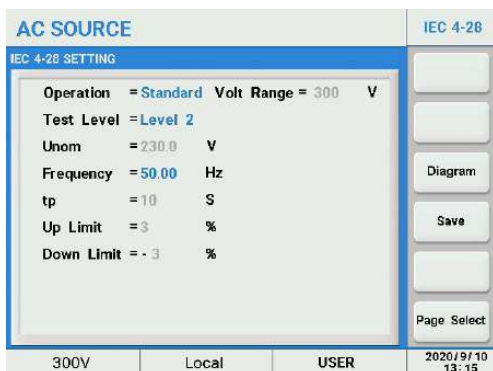

Unom= nominal test voltage, fixed at 230V in Standard mode, can be edited in User Def. mode.
Frequency= fixed at 50Hz or 60Hz in Standard mode, can be edited in User Def. mode.
tp = rise or fall time.
Up Limit = percentage of Nominal Frequency.
DownLimit = percentage of Nominal Frequency.

5. Press the 'Diagram' soft key to see a visual representation of the test waveform.
 Press again to clear the preview.
6. Press the 'Save' soft key to store the test setting in non-volatile memory.

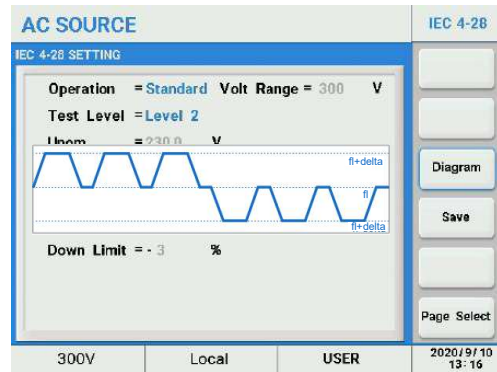

7. Press the [ESC] key to return to the previous screen then press the 'Trigger' soft key to load the settings.
8. Press the 'Trigger' soft key to apply the test to the unit under test. Once pressed, it changes to 'Stop'.

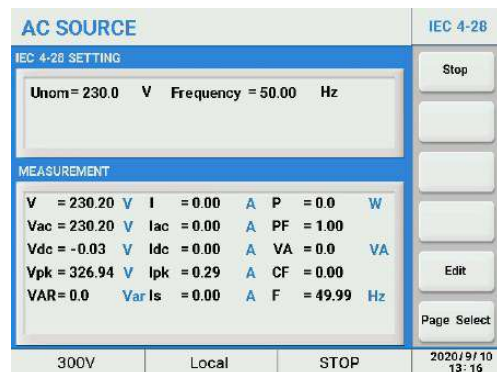
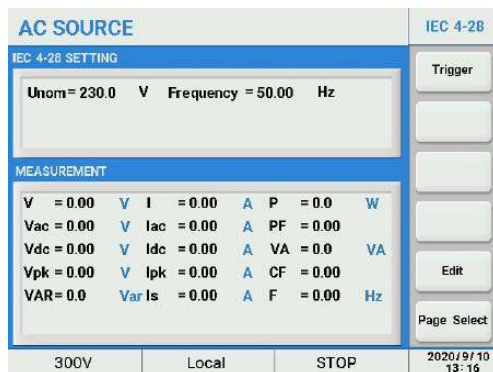

At the completion of the test, the 'Stop' soft key will revert to 'Trigger'. To abort a test in progress, press the 'Stop' soft key during a test run.

5.2.3.4 Special Function

This series AC source support the following special test function:

- Transient
- Trac Dimmer

In the 'Output Mode' screen press the 'Special Function' soft key to display the right screen.

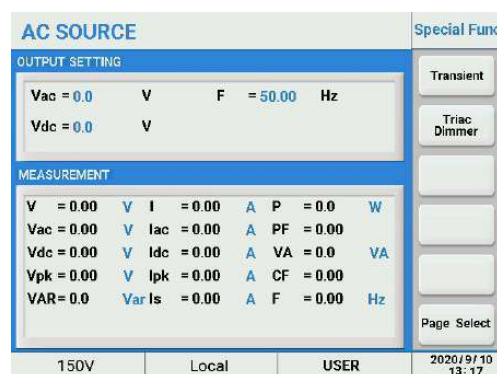

1. Transient

Transient test simulates the effects of high speed voltage spikes and sags on a unit under test.

1. In the 'Special Func' screen press the 'Transient' soft key to select the Transient test mode.
2. Press the 'Edit' soft key to set the parameters.

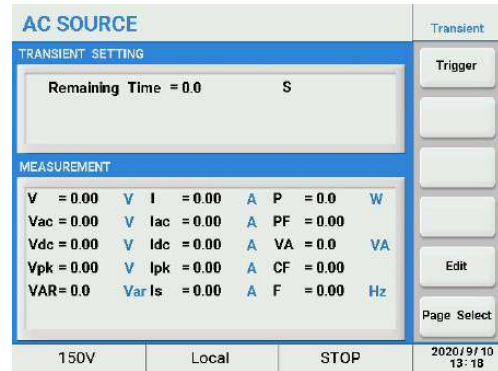
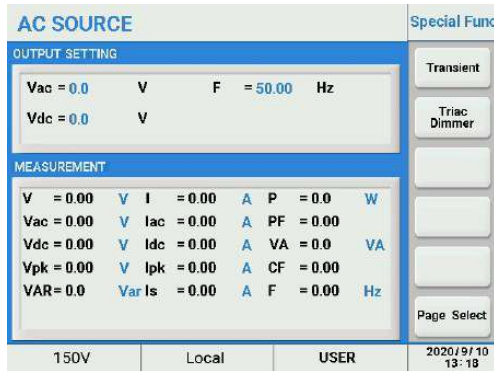

Trans-Start : to set the time of the first transient.

Trans-Volt: to set the voltage of the transient(s) : detailed information refer to Technical Specifications

Trans-Time : to set the duration of the transient(s).

Trans-Count : to set the number of times the transient is repeated.

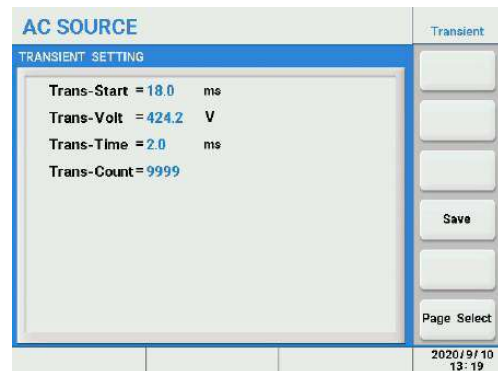

3. Press the 'Save' soft key to save the transient settings to non-volatile memory.
4. Press the [ESC] key to return to the previous screen then press the 'Trigger' soft key to load the settings.
5. Press the 'Trigger' soft key to apply the test to the unit under test. Once pressed, it changes to 'Stop'.

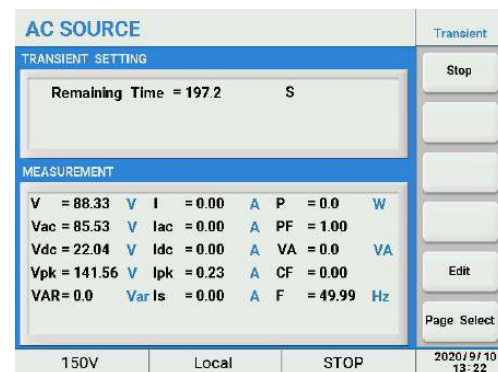
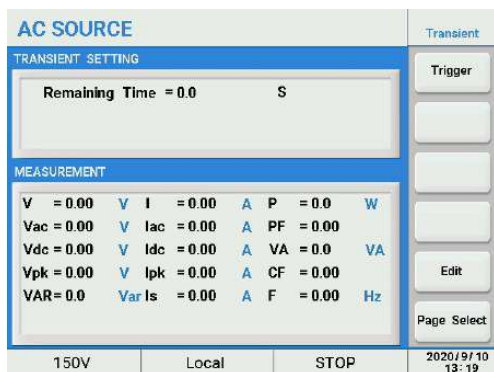

2. Triac Dimmer

The leading or lagging edge of the voltage waveform can be blanked with a phase angle set by the Triac Dimmer function to regulate the active power, thus adjusting the lighting intensity in the case of a luminary load.

1. Press the 'Triac Dimmer' soft key to select the Triac Dimmer test mode.
2. Press the 'Edit' soft key to enter edit mode.

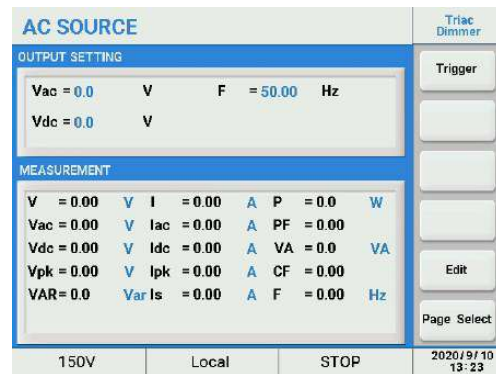
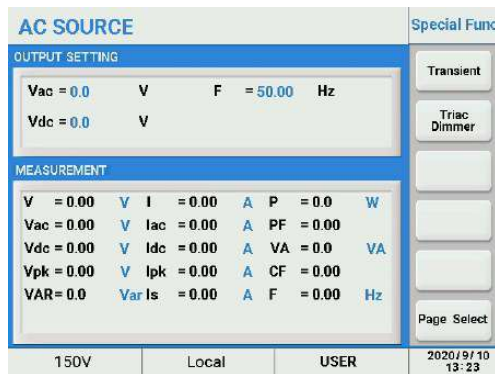

Edge: to set the dimmer of leading edge or trailing edge mode.

Degree; phase angle of the blanking period.

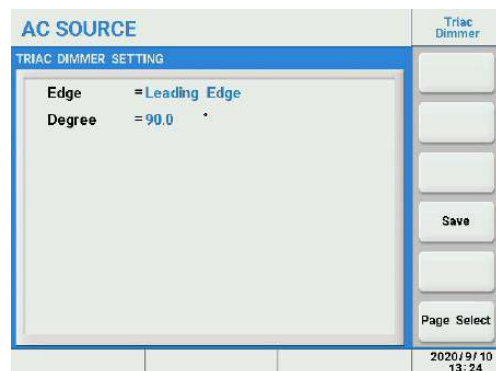

3. Press the 'Save' soft key to save the settings to non-volatile memory.
4. Press the [ESC] key to return to the previous screen then press the 'Trigger' key to load the settings.
5. Press the 'Trigger' soft key to apply the test to the unit under test. Once pressed, it changes to 'Stop'.

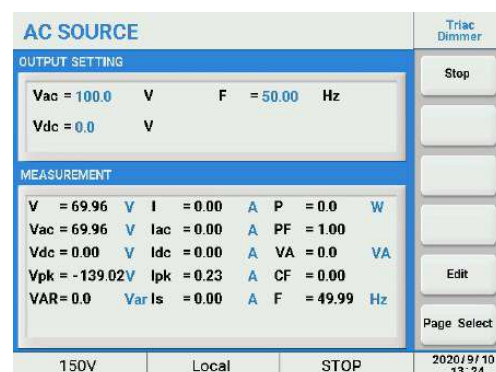
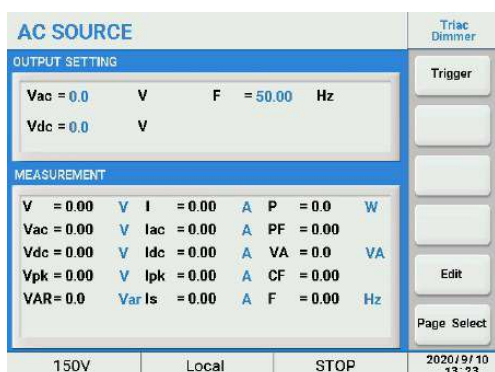

5.2.3.5 Test Mode

This menu provides users a function to compare the measured parameters with that entered in testing parameters screen. These include 'I', 'Iac', 'Idc', 'Ipk', 'Is', 'P', 'PF', 'VA', 'CF', 'VAR'.

PASS or FAIL will be displayed on the screen accordingly.

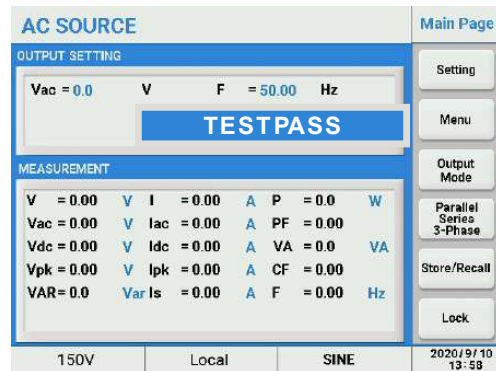

1. In the 'Output Mode' screen press the 'Test Mode' soft key to enter limit test mode.

Low Limit : lower limit of parameter settings.

High Limit : upper limit of parameter settings.

Switch : selectable to Disable or Enable.

Delay Time : the delay time to enter into test mode when output is turned ON

Test Time : duration of measurement and limit compare period.

Remaining Time : the time remaining in the test process.

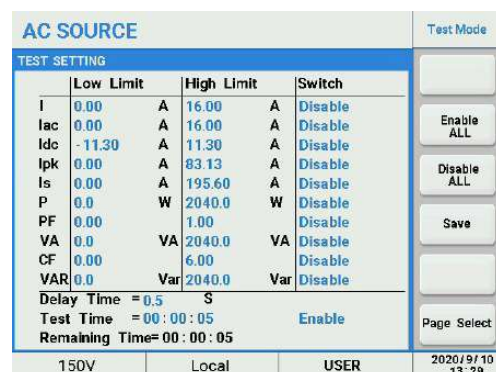
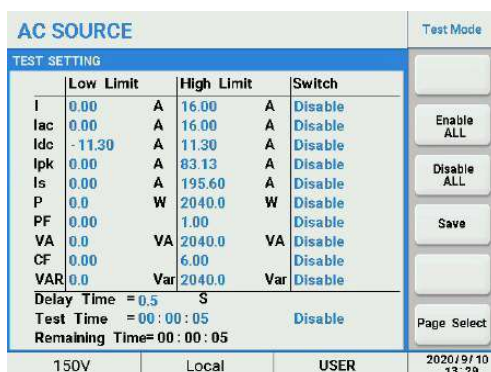
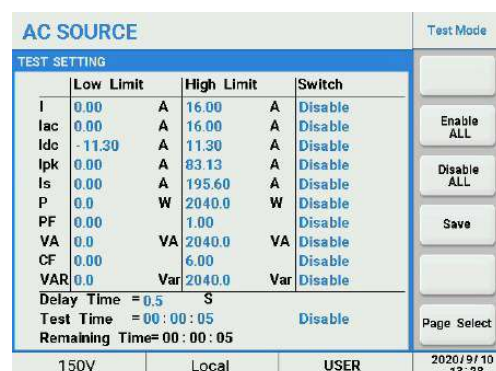
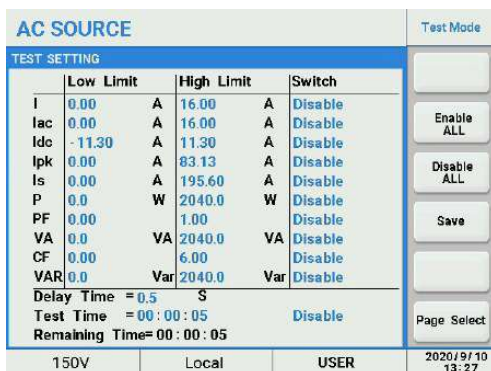

2. Press the 'Save' soft key to save the settings to non-volatile memory.

Once the output is turned on, the measurements will start and compare against the limits set for the period of time programmed. A PASS or FAIL Result will be displayed when the total time period is over.

Note

- If the remote I/O & Parallel Multiphase Link Card has been connected, the testing result (PASS or FAIL) and the output state (ON/OFF) can be detected from Relay 1~3.

5.2.4 Parallel/Series/3-Phase

For details on Master-slave mode operation, please refer to Chapter 6.

5.2.5 Store/Recall

The memory resources are accessed using the following four soft keys:

- Save Output
- Save System
- Recall Output
- Recall System



In the 'Main Page' screen press the 'Save/Recall' soft key to enter the save/recall sub-menu.

1. Save Output/Recall Output

This AC source provides 51 non-volatile memory registers to save instrument settings for recalling at a later time. Parameters that may be saved include 'Vac', 'F', 'Vdc'.

1. Press the 'Store/Recall' to save an output setting.
2. Move the cursor to the Channel field located in the middle of the screen. Use [0]~[9] keys to select a channel number from 1 through 51 and press [Enter] key to save the output settings to this Channel register.



3. To recall the output settings stored in Channel [3] for example. Press the 'Recall Output' soft key, then move cursor to the Channel field, use [3] + [Enter] keys to recall the output settings.

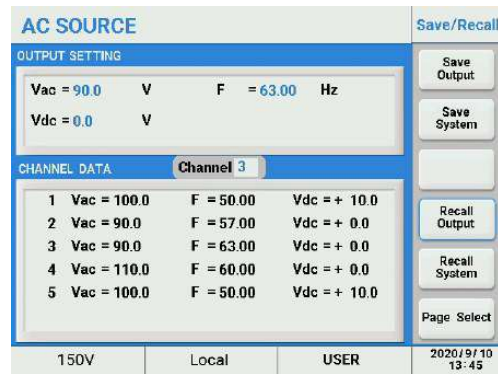

2. Save System/Recall System

This AC source provides 5 non-volatile memory groups to save instrument system settings for recalling at a later time.

1. Press the 'Store/Recall' to save a system setting.
2. Move the cursor to the Group field located in the middle of the screen. Use [0]~[9] keys to select a group number from 1 through 9 and press [Enter] key to save the system settings to this group register.

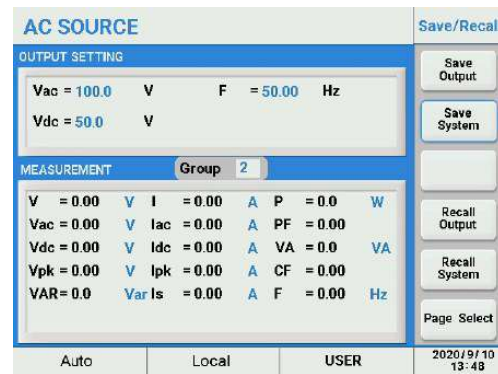
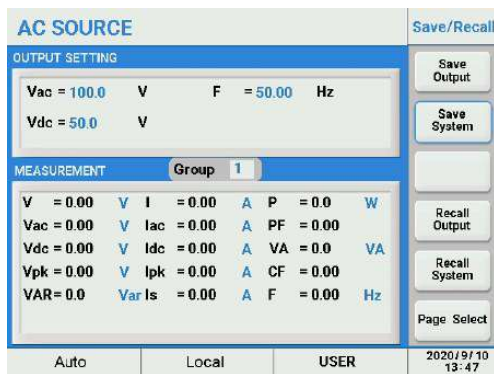

3. To recall the system settings stored in Group [5] for example. Press the 'Recall System' soft key, then move cursor to the Group field, use [5] + [Enter] keys to recall the system settings.

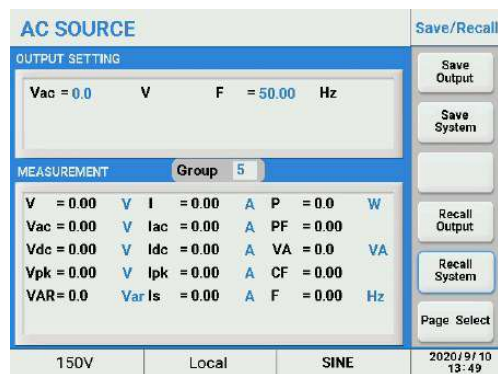
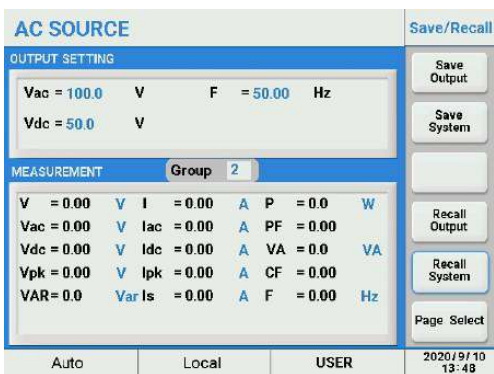

5.2.6 Lock

The front panel keys and touch screen operation can be locked to prevent unwanted changes to output settings and the AC source configuration. To lock the front panel keys and touch screen from the 'Main Page' screen press the soft key to the right of 'Lock'. A lock sign will be displayed on the bottom right of the screen. Press the period key [,] on the front panel to unlock the front panel keys and touch screen.

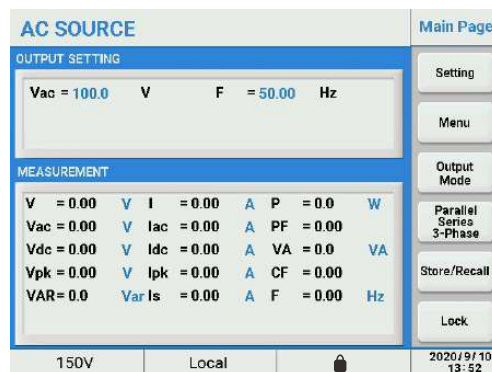
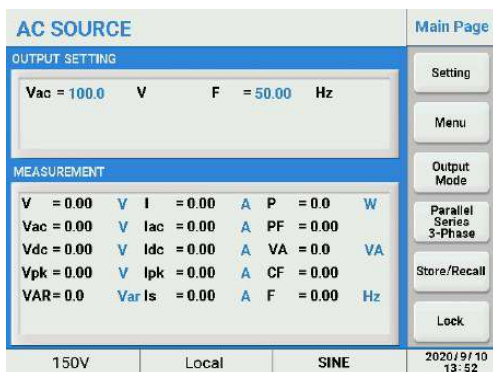

Chapter 6 : Master-slave Mode Operation

ACPS Series Programmable AC Power Supply can be connected in parallel/series and 3-phase system to increase the output power.

Note

- DONOT connect units in both series and parallel at the same time.
- DONOT connect different models in parallel or series mode.
- Up to 2 units connected in series, 4 units connected in parallel in master-slave mode.
- Set up all Slave units first, then set up the Master in Master/Slave configuration.
- There can only be ONE Master unit in any Master/Slave configuration.
- Each Slave unit's number Must be unique or the master-slave mode cannot be set.

6.1 Setting the Units as Slave

Note

- Set the slave unit as 'Slaver1' in series connection mode.

1. Press the soft key to the right of 'Parallel Serial 3-Phase'.
2. Press the [Cursor] key to highlight the 'Mode = field, and press the [Enter] key to confirm.

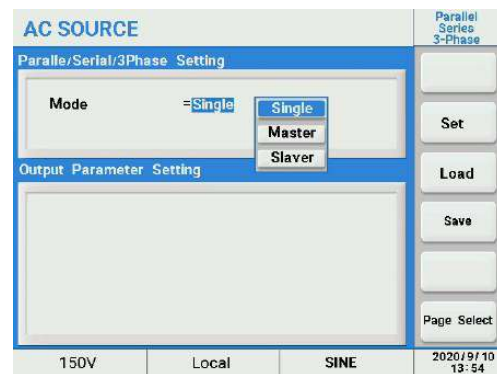
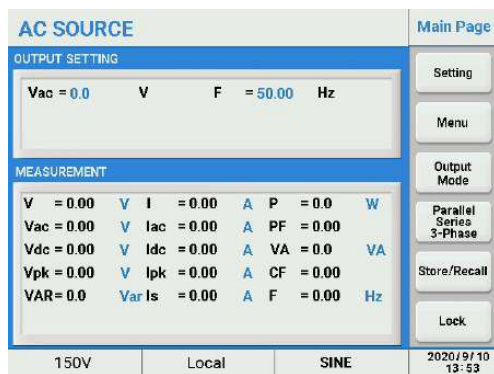

3. Move the cursor to highlight 'Slaver' option and press the [Enter] key to confirm.
4. Move the cursor to the command line 'Slaver Type =' and select the slaver number, then press the [Enter] key to confirm.

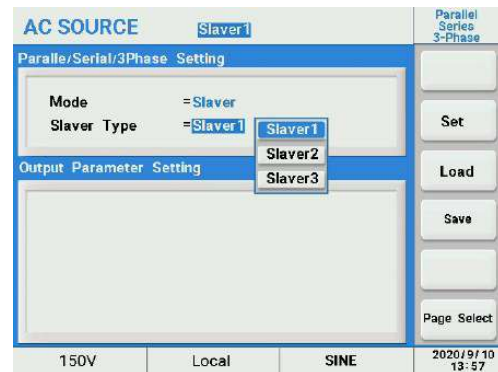
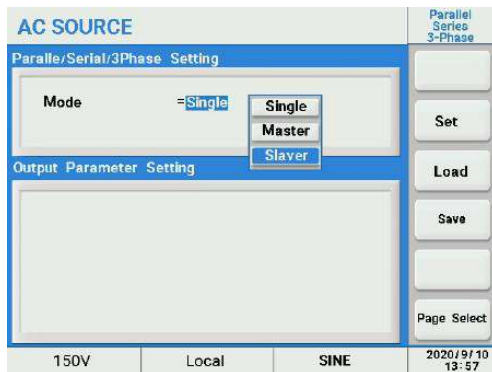

5. Press the 'Set' soft key to save the setting, then the slave units will be locked.
6. Press the 'Load' soft key to recall and display the saved state of this unit.
7. Press the 'Save' soft key to store the master-slave mode setting to non-volatile memory.



Warning!

- The Slave units can be unlocked by pressing the [,] key on the front panel.
- Never change the configuration and modes of Master and Slave units while in Mater/Slave mode operation as it could damage the units.

6.2 Setting the Unit as Master

1. Press the soft key to the right of 'Parallel Series 3-Phase'.
2. Press the [Cursor] key to highlight 'Mode = field, and press the [Enter] key to confirm.

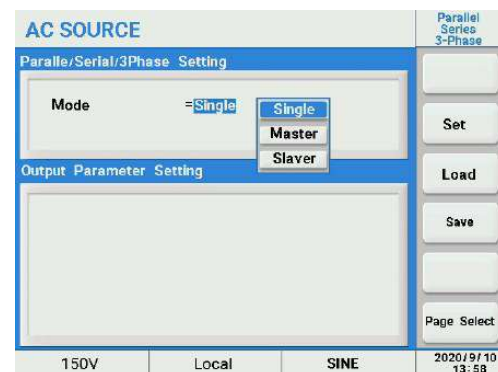
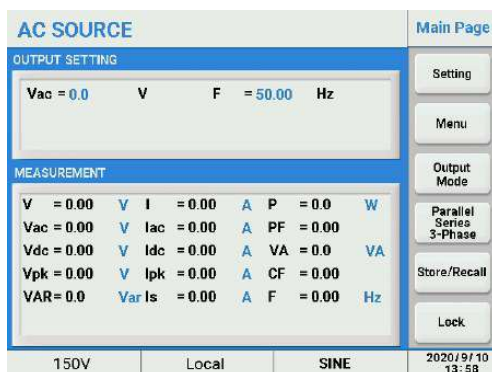

3. Move the cursor to highlight 'Master' option and press the [Enter] key to confirm.
4. Move the cursor to highlight the 'Master Type =' field and press the [Enter] key to confirm.
5. Move the cursor to highlight the right option and press the [Enter] key to confirm.

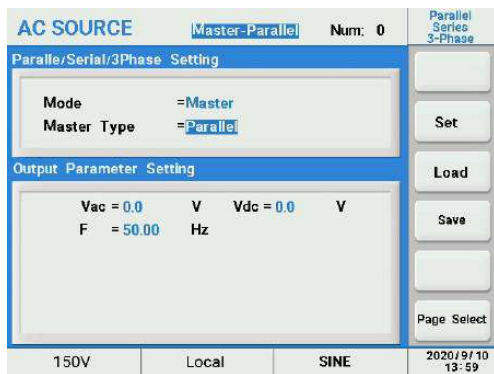

6. Press the 'Set' soft key to save the setting, then the slave units will be locked.



7. Press the 'Load' soft key to recall and display the saved state of this unit.
8. Press the 'Save' soft key to store the master-slave mode setting to non-volatile memory.

6.2.1 Parallel System

Set 'Master Type' of the master unit as 'Parallel', then press the [Main] key switch to main menu.



Parallel connection

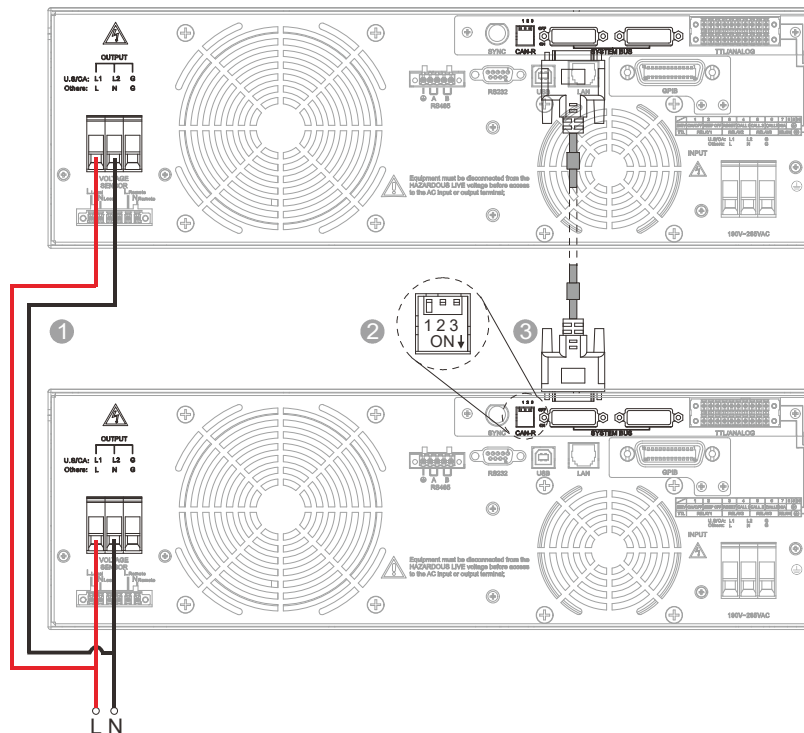

- ① Output connection
- ② Termination resistor CAN-R, flip Dip Switch 1 of the Master unit to ON position (down)
- ③ System Bus Communication Cable

6.2.2 Series System

Set 'Master Type' of the master unit as 'Series', then press the [Main] key to return to the main page.

AC SOURCE	Serial-Master	Num: 0	Parallel Series 3-Phase
Paralle/Serial/3Phase Setting			
Mode	=Master		
Master Type	=Series		
Output Parameter Setting			
Vac = 150.0	V	Vdc = 0.0	V
F = 50.00	Hz		
150V	Local	SINE	2020/9/10 14:03

AC SOURCE	Serial-Master	Num: 0	Main Page
OUTPUT SETTING			
Vac = 150.0	V	F = 50.00	Hz
MEASUREMENT			
V = 0.00	V I = 0.00	A P = 0.00	W
Vac = 0.00	V Iac = 0.00	A PF = 0.00	
Vdc = 0.00	V Idc = 0.00	A VA = 0.00	VA
Vpk = 0.00	V Ipk = 0.00	A CF = 0.00	
VAR = 0.0	Var Is = 0.00	A F = 0.00	Hz
Ev = 0.00	V Σr = 0.00	A Σr = 0.0	W
150V	Local	SINE	2020/9/10 14:03

Series connection

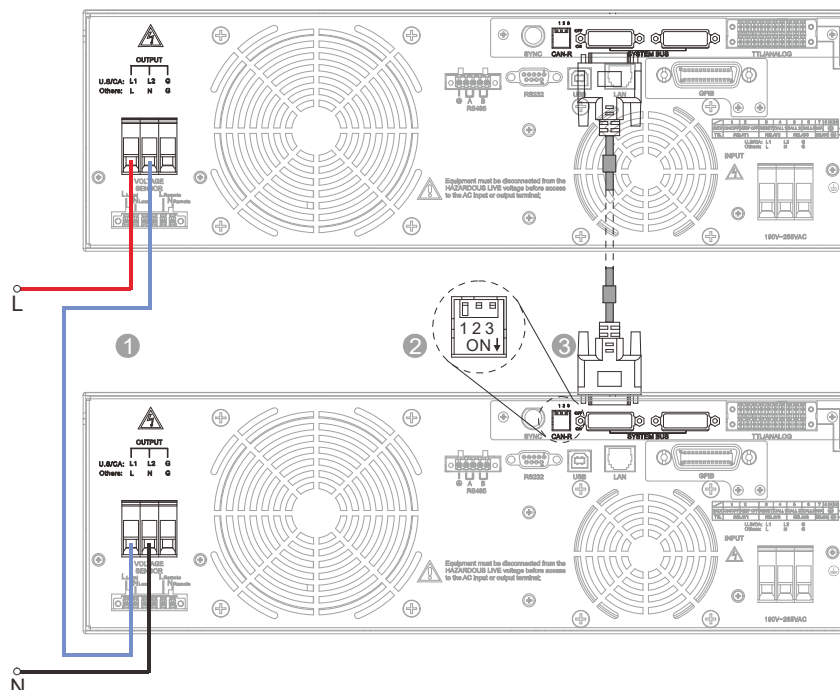

- ① Output connection
- ② Termination resistor CAN-R, flip Dip Switch 1 of the Master unit to ON position (down)
- ③ System Bus Communication Cable

6.2.3 3-Phase System

The output of the 3-Phase system can be connected for three-phase four-wire (Y type) system or three-phase five-wire (Δ type) system.

Note

- In this 3-phase system, the Master unit is always phase A, Slave1 is always phase B and Slave2 is always phase C.

Note

- In this 3-phase system, the output voltage of phase B and C will be set to the same settings as that for phase A automatically if the Voltage Mode is set to COM. If the Voltage Mode is set to Multi, phase B and C output voltage can be set individually.
- The output frequency of phase B and C is always set to the same frequency as phase A. The phase difference between phase A and B is always 120° and between phase A and C is always 240° .
- In this 3-phase system, the waveform generator A or B only can be switched after the system output off.

Set 'Master Type' of the master unit as '3 Phase', then press the [Main] key to return to the main page.



Main page



Three-phase five-wire (Y type) connection, the output voltage range is 0~300V.

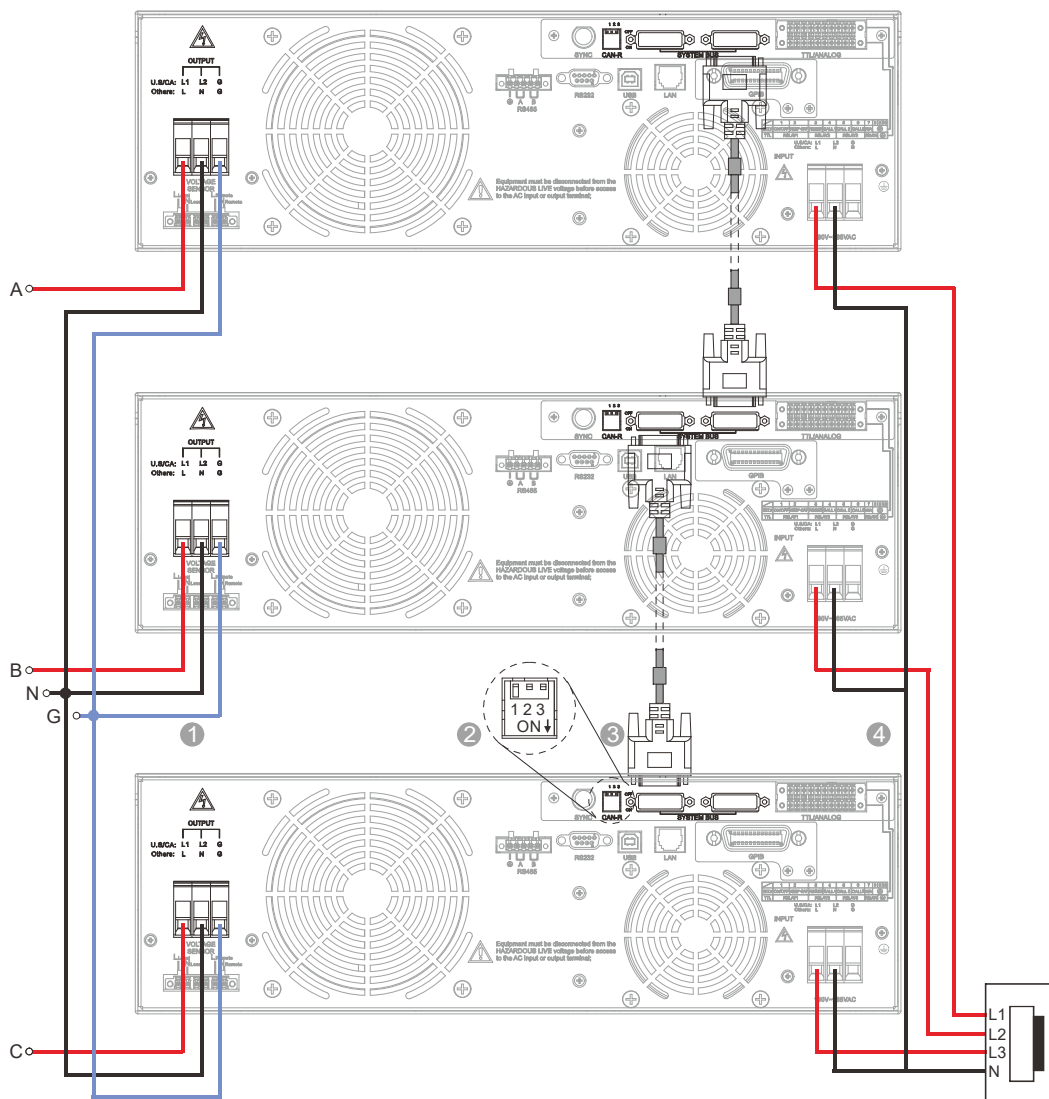

- ① Output connection
- ② Termination resistor CAN-R, flip Dip Switch 1 of the Master unit to ON position (down)
- ③ System Bus Communication Cable
- ④ Only support three-phase five-wire input connection

Three-phase four-wire (Δ type) connection, the output voltage range is 0~519V.

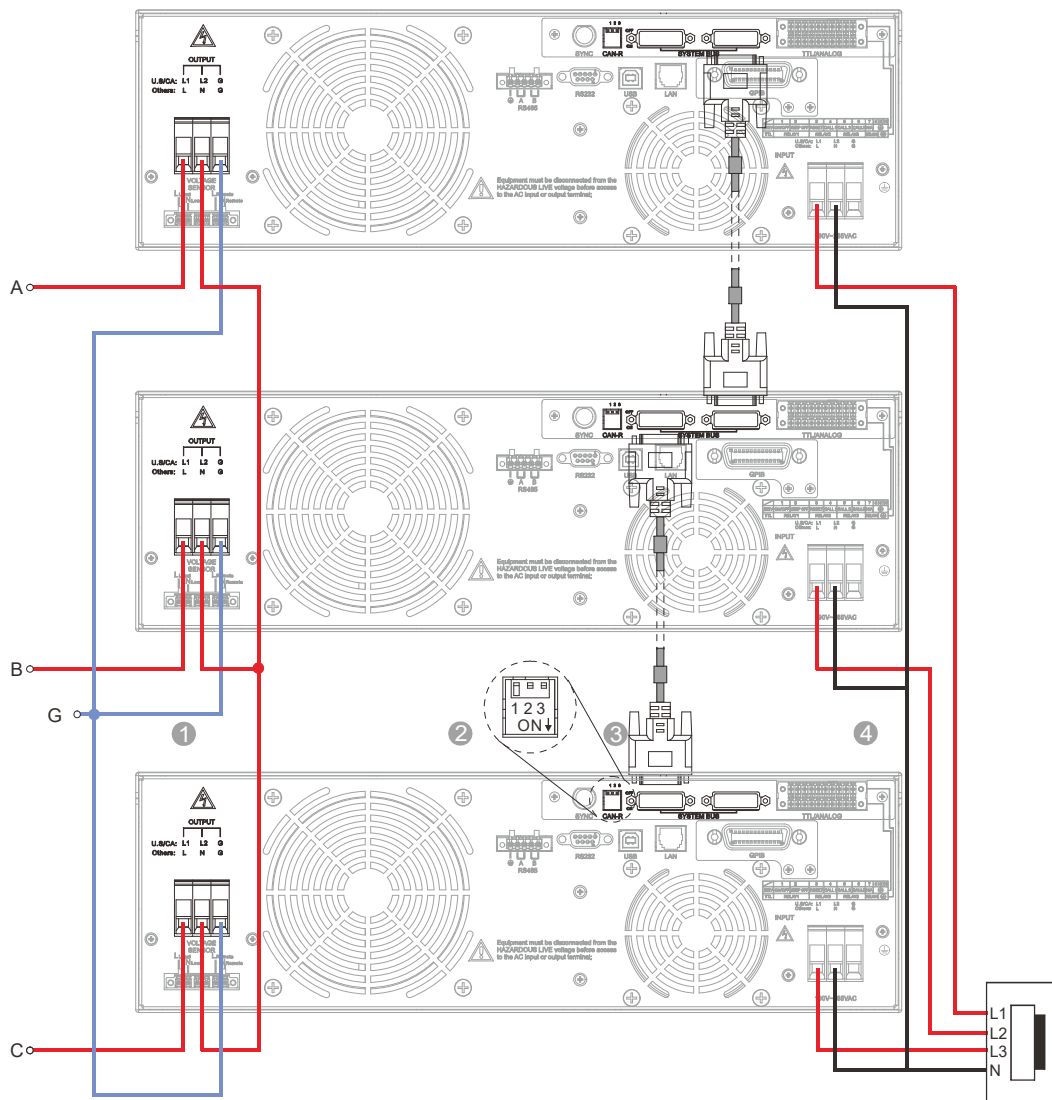

- ① Output connection
- ② Termination resistor CAN-R, flip Dip Switch 1 of the Master unit to ON position
- ③ System Bus Communication Cable
- ④ Only support three-phase five-wire input connection

6.2.4 Error List of Master-slave Mode

Alarm Code	Information	Instruction
0x0401	Mode Not Match	Mode not match
0x0402	Model Not Match	Model not match
0x0404	No Phase B	No Phase B
0x0408	No Phase C	No Phase C
0x0410	Master Conflict	More than one mater units in the system
0x0420	CAN No Slave	No salver can be found
0x0420	CAN No Master	No Master can be found
0x0480	Slave Conflict	More than one slavers have the same number
0x0500	Slave offline	Slave offline

6.2.5 Function Instruction

Menu	Sub-menu	Single Unit	Parallel System	Series System	3-Phase System
Output & More Setting	Waveform	Yes	Yes, slavers in sync with the master unit		
	On Degree	Yes	Yes, slavers in sync with the master unit	Applies to phase A only. Phase B & C will be shifted 120° & 240° .	
	Off Degree	Yes	Yes, slavers in sync with the master unit		
	Soft Start ⁽¹⁾	Yes	Yes, slavers in sync with the master unit		
	Coupling	Yes	Yes, slavers in sync with the master unit		
	Range	Yes	Yes, slavers in sync with the master unit		
	Waveform Preview	Yes	Yes, but only the master unit can display		
	Zo Program	Yes	Not Supported	Not Supported	Not Supported
Measure Setting	lrange	Yes	Yes, slavers in sync with the master unit		
	Average	Yes	Yes	Yes	Yes
	Is Delay	Yes	Yes	Yes	Yes
	Is Interval	Yes	Yes	Yes	Yes

Menu	Sub-menu	Single Unit	Parallel System	Series System	3-Phase System
Waveform Viewer		Yes	Yes	Yes	Yes
Limitation		Yes	Yes, slavers in sync with the master unit		
Config	Remote Control	Yes	Yes	Yes	Yes
	System Setting ^[2]	Yes	Yes	Yes	Yes
	System Information	Yes	Yes	Yes	Yes
	External Control	Yes	Yes	Yes	Not Support
	Protection	Yes	Yes, slavers in sync with the master unit		
LCD Setting		Yes	Yes	Yes	Yes
Calibration ^[3]		Yes	Not Supported	Not Supported	Not Supported
Other		Yes	Yes	Yes	Yes
Output Mode	PLD Testing	Yes	Yes	Yes	Yes
	Harmonics ^[4]	Yes	Yes	Yes	Not Supported
	IEC Standard ^[5]	Yes	Yes	Yes	Yes
	Special Function	Yes	Yes	Yes	Not Supported
	Test Mode	Yes	Not Supported	Not Supported	Not Supported
Store/Recall		Yes	Yes	Yes	Yes

[1] Soft Start includes Vac S/R, Vdc S/R and F S/R setting.

[2] O/P Relay function set as ON only available in single mode.

[3] Calibration function only available for single unit.

[4] Harmonics function only available for the master unit.

[5] Only IEC61000-4-11 available for the 3-phase system.

Chapter 7 : Calibration

The AC source allows the user to calibrate the unit through the menu including Voltage Setting and Voltage and Current Measurement. The user can selectively calibrate these items, though it is best if a calibration lab performs the calibration.

7.1 Calibration Equipment Required

1. Calibrated, traceable, 4 1/2 digit digital voltmeter (DVM) 300Vac RMS minimum.
2. Calibrated, traceable, 4 1/2 digit digital ammeter (DAM) 25A RMS minimum.
3. Suitably rated Resistive Load, 240V minimum.

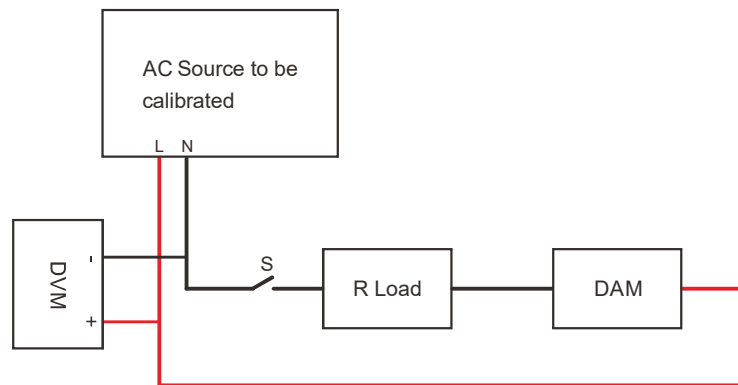

7.2 Calibration Procedure

In the 'Menu' screen press the 'Calibration' soft key to select the calibration item, then move the cursor to highlight the password data field.

Using the number keys enter the password "9527" and press the [Enter] key to confirm.

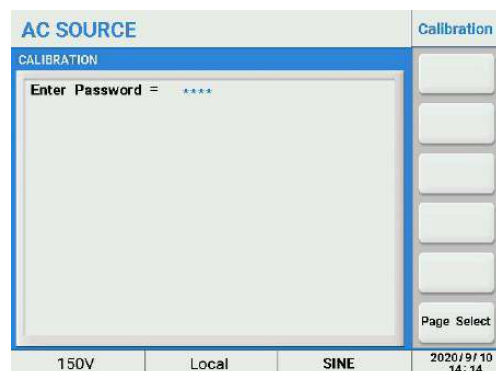
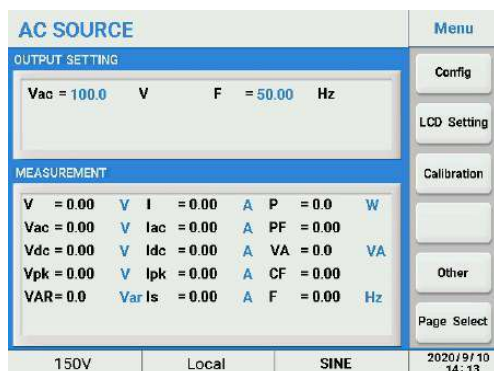

7.2.1 Volt Setting & Measurement Calibration

This item is for calibrating the voltage setting and measurement. Make sure to disconnect the Resistive load before starting calibration.

1. Once the password has been entered press the soft key to the right of 'Volt Setting & Measure'.
2. You will enter into the 150V Range voltage calibration. Make sure there is NO Load at the output. Then press the 'Continue' soft key for the next step.

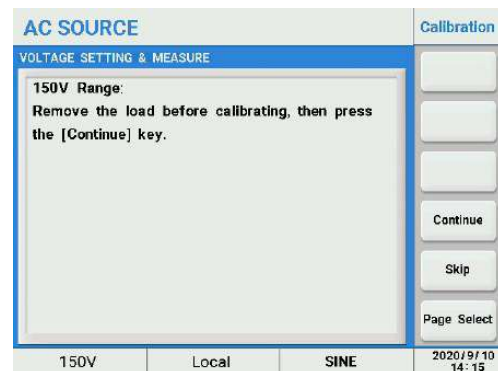
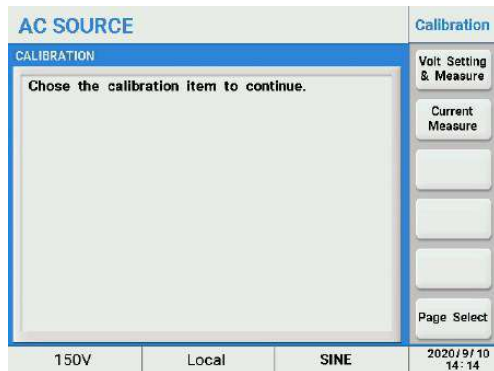

3. Highlight the value field and enter the DVM DC voltage reading and repeat this step until the DVM reading is between -10mV and 10mV.

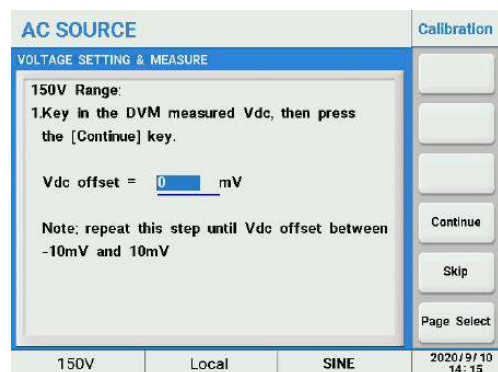
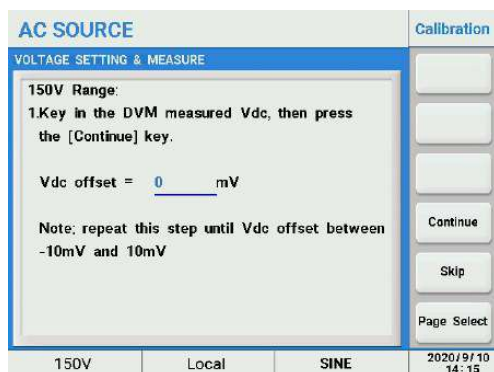

4. Wait 2 seconds then press the 'Continue' key.
5. Highlight the value field and enter the DVM AC voltage reading then press the 'Continue' soft key for the next step.

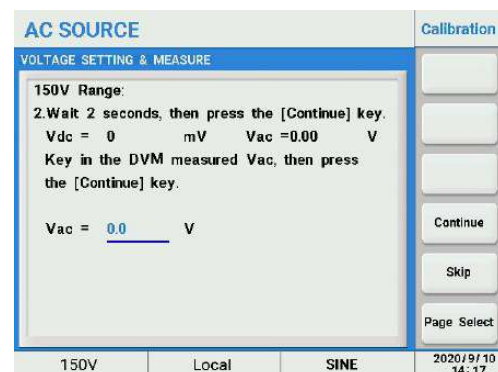
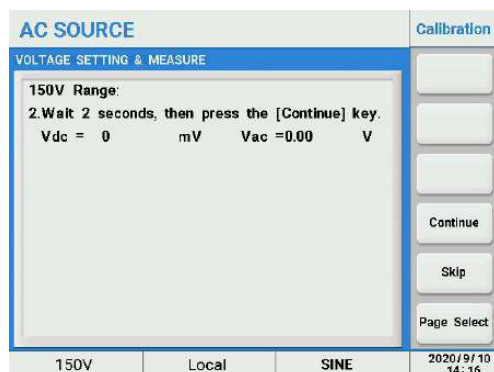

Follow the on-screen prompts to complete calibration the 150V AC range. Both AC & DC output and AC & DC measurements are calibrated.

Once completed, repeat the same process for the 300V AC range.

7.2.2 Current Measurement Calibration

This menu is for calibration of the power source's current measurement functions. The power source uses up to four measurement ranges depending on models. Each range has two calibration coefficients.

Follow the on-screen prompts to complete the complete calibration sequence for all ranges and coefficients.

Once the password has been entered press the soft key to the right of 'Current Measure'.

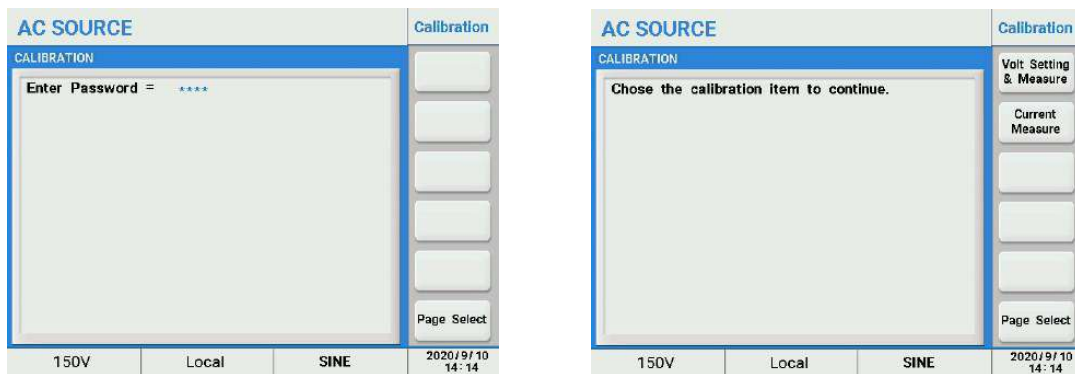

7.2.2.1 I Range High, AC Low Current Coefficient

1. Make sure the load is connected (switch is closed) and adjust the load setting for a current of 1 Aac +/- 10%.
2. Highlight the Measured I field value, then enter the current reading from the DAM.

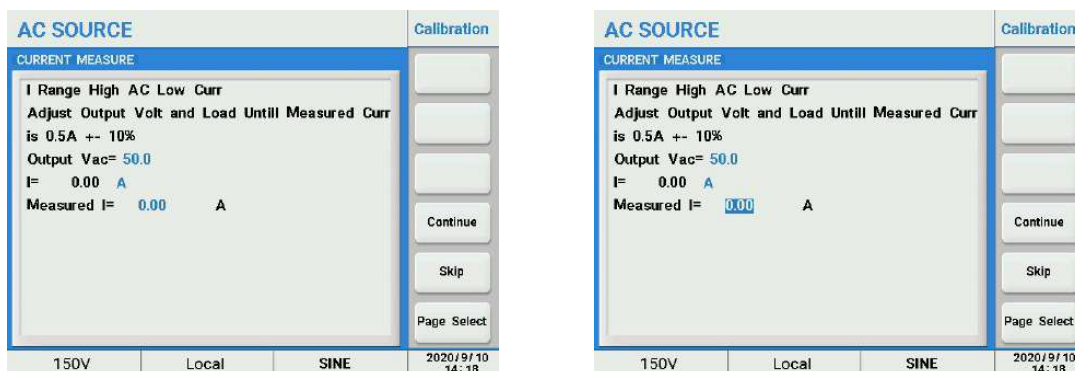

When done, press the 'Continue' key to the next calibration coefficient.

7.2.2.2 I Range High, AC High Current Coefficient

The next calibration point is for high AC current measurements. Adjust the load to 24 Aac.

Note: Depending on the power model and max. current rating, the actual high current value may be different that shown in this example. Always follow the on-screen prompted current setting values.

1. Adjust the load setting for a current of 24 Aac +/- 10%.
2. Highlight the Measured I field value, then enter the current reading from the DAM.

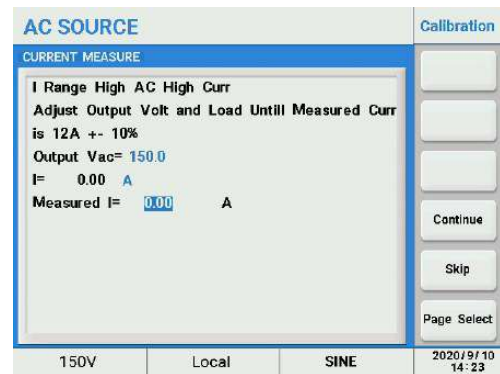
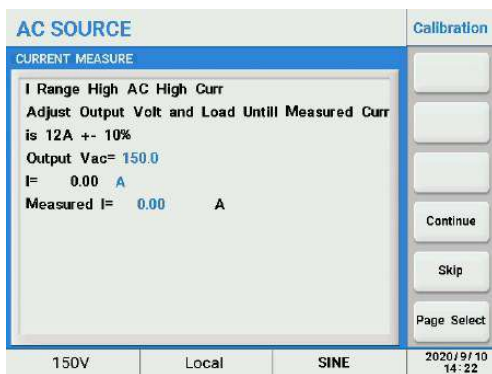

When done, press the [Continue] key to the next calibration coefficient.

7.2.2.3 I Range High,DC Low Current Coefficient

1. Adjust the load setting for a current of 0.5 Adc +/- 10%.
2. Highlight the Measured I field value, then enter the current reading from the DAM.

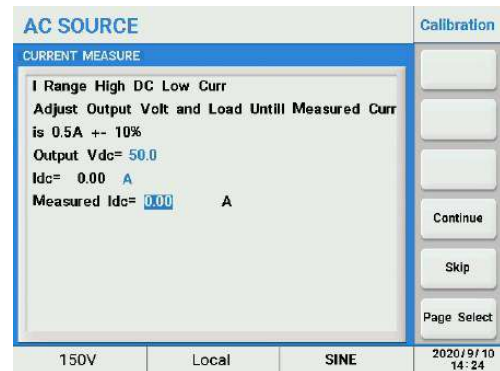
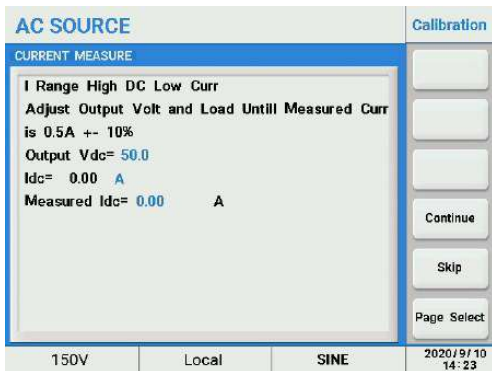

When done, press the 'Continue' key to the next calibration coefficient.

7.2.2.4 I Range High, DC High Current Coefficient

1. Adjust the load setting for a current of 16 Adc +/- 10%.
2. Highlight the Measured I field value, then enter the current reading from the DAM.

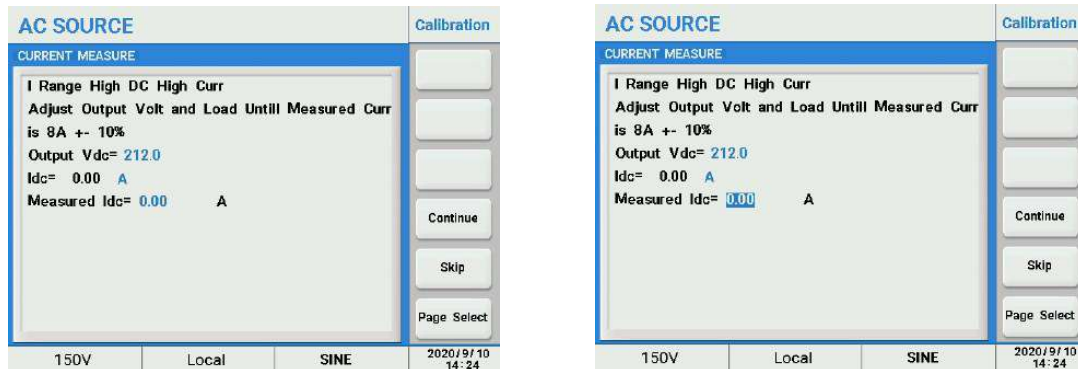

When done, press the 'Continue' key to the next calibration coefficient. Continue to follow the on-screen prompts till the calibration process for Middle and Low current measurement calibration is complete.

Note

- It is possible to skip any coefficient by press the 'Skip' soft key if calibration is deemed but it is better to follow the prompt messages provided on the display, step by step.

7.2.3 Saving Calibration Coefficients

Once all calibration steps are completed, press the 'Yes' soft key to save the new coefficient values. Press No means the old calibration coefficient will be retained.

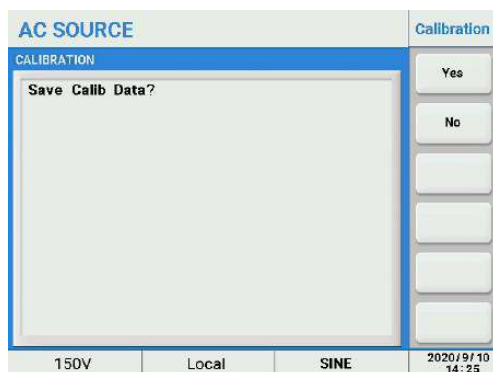

Chapter 8 : Installation

8.1 Product Dimensions

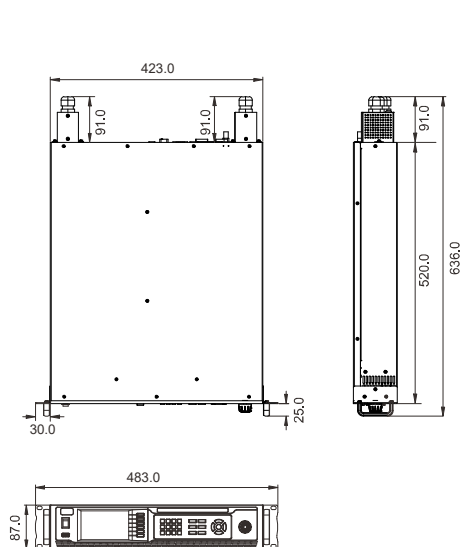

Dimensions of 2U Models

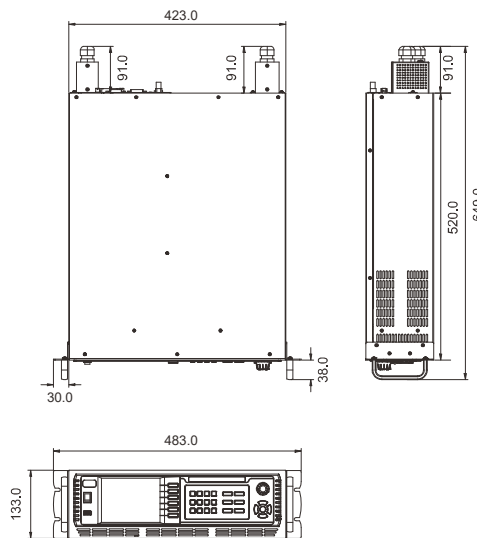

Dimensions of 3U Models

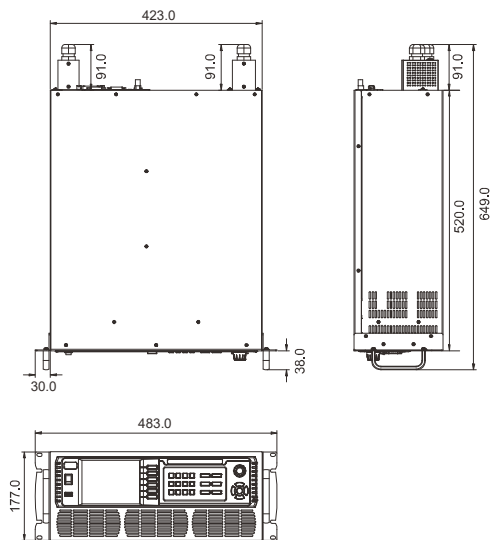

Dimensions of 4U Models

Note: refer to technical specifications to get the detailed information of the dimensions of the power sources.

8.2 Installing Rack Mount Handles



Caution!

- The handles are used to fix the unit in the rack instead of carrying the unit.

Install the rack mount handles provided in the ship kit on the power source before mounting the unit in an instrument rack.

Refer to the illustration on the right for correct assembly. The required screws are included in the ship kit.

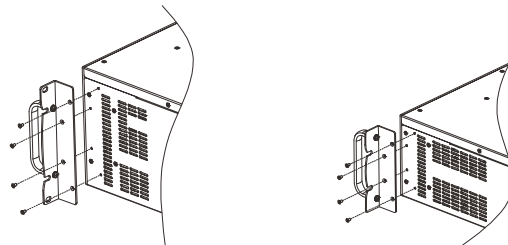

8.3 Installing the Optional Cards

This series AC source provides optional interface cards. The interface slot is located on the rear panel, making it easy for the user to plug a new interface or replace an existing one.

Refer to the illustration on the right for correct assembly.

Optional interface cards for this series AC source are as below.

- Remote I/O Card
- GPIB & LAN Communication Card

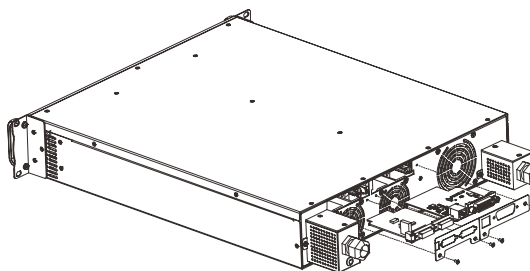
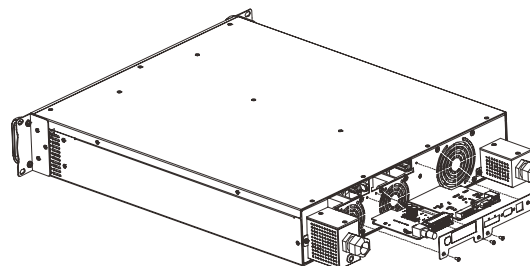

Illustration of 2U Models

This series AC source provides optional interface cards. The interface slot is located on the rear panel, making it easy for the user to plug a new interface.

Refer to the illustration on the right for correct assembly.

Optional interface cards for this series AC source are as below.

- Remote I/O & Parallel Multiphase Link Card
- GPIB Communication Card

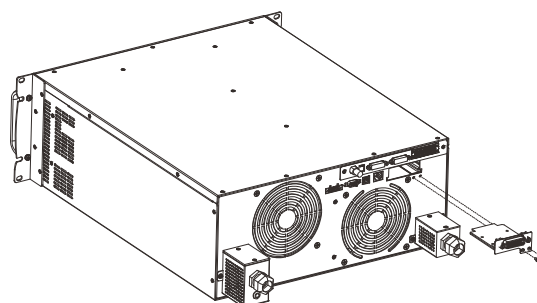
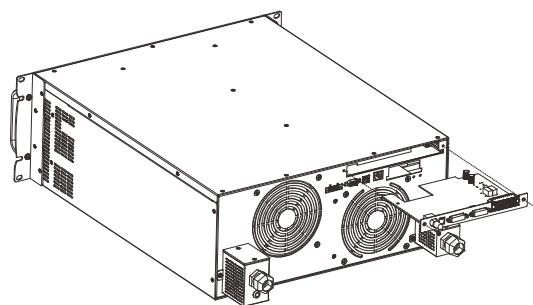

Illustration of 3U Units

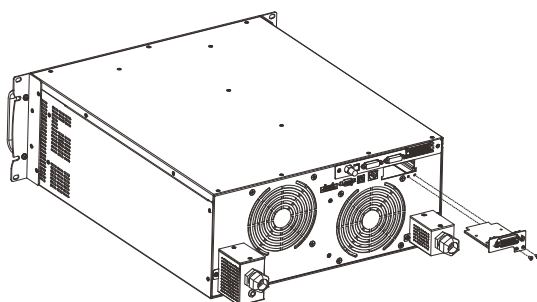
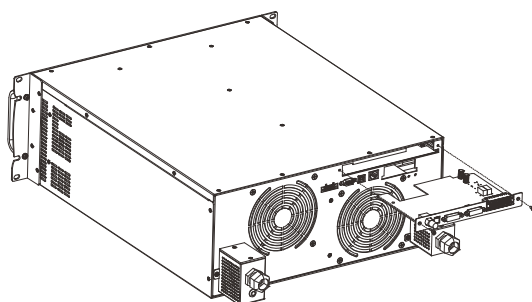

Illustration of 4U Units

This series AC source provides optional interface cards. The interface slot is located on the rear panel, making it easy for the user to plug a new interface.

Refer to the illustration on the right for correct assembly.

Optional interface cards for this series AC source are as below.

- Remote I/O & Parallel Multiphase Link Card
- GPIB Communication Card

8.4 Shelf Mounting Diagram of AC Source

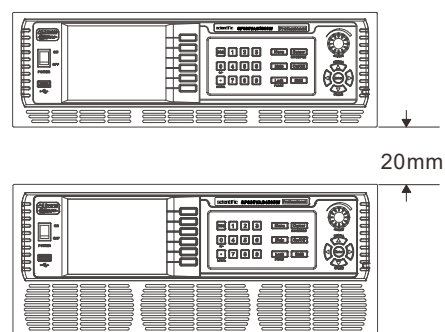
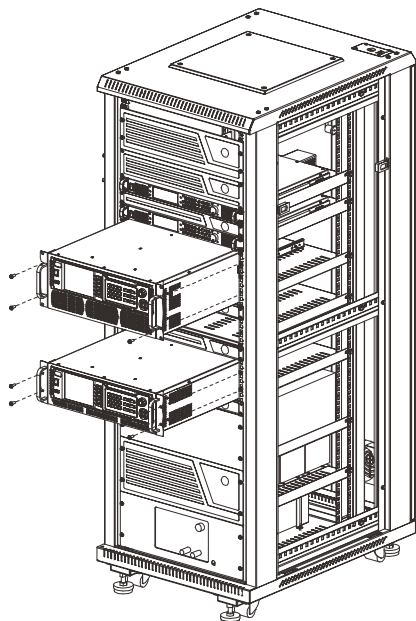

ACPS Programmable AC Power Supply can be installed in a standard 19-inch equipment rack, to make it easy to integrate it into your test system. Due to the weight of the unit a shelf or rear support is needed in addition to the supplied front panel brackets.

Be sure to leave clearance for additional cooling airflow intake on the sides of the unit.

8.5 Input Connection



Warning!

- Be sure to disconnect the AC mains before accessing the AC output and AC input compartment or connectors.
- Be sure to connect the green/yellow wire to connect the earth (⊕) terminal of the AC Power input terminal block to earth ground, otherwise an electric shock hazard may exist!
- There is certain danger if the connection of AC power source is not done properly, please assure that the AC power cable is installed by a qualified electrician or technologist. Also if the unit AC input is to be hardwired please assure that this is done by only a qualified electrician.
- It is suggested to use an external circuit breaker which protects, and can disconnect all the current carrying conductors for the AC input cable.

Note

- Instruction not to position the equipment so that it is difficult to operate the disconnecting device.
- Approved flexible cords with double insulation, suitable size, min. 60 deg C as in the following table must be used as AC input.
- For ACPS5000 input current limit within 30A. Once the input current greater than 30A, output power is reduced.

Model	Wire Size	Input Breaker	Model	Wire Size	Input Breaker
ACPS600W	1.6 mm ² /14 AWG	10 A	ACPS3000W	2 mm ² /12 AWG	25 A
ACPS1000W	2 mm ² /12 AWG	20 A	ACPS4000W	4 mm ² /6 AWG	30 A
ACPS1500W	2 mm ² /12 AWG	25 A	ACPS5000W	4 mm ² /6 AWG	40 A
ACPS2000W	2 mm ² /12 AWG	20 A			

1. Strip the outside insulation of the AC cable approximately 25mm. Strip 7mm of insulation from the end of each of the wires.
2. Loosen the plastic nut of the supplied cable strain relief clamp.
3. Pass the cable end including the line wire, neutral wire, and ground wire through the cable clamp and nut according to the direction of the drawing below, and then insert it into the line, neutral, and ground terminals respectively.
4. Using a suitably sized flat blade screwdriver tighten the screws on the top of terminal block assuring the wires are held tightly.
5. Replace and fasten the terminal cover box, and tighten the plastic nut of the cable strain relief clamp.

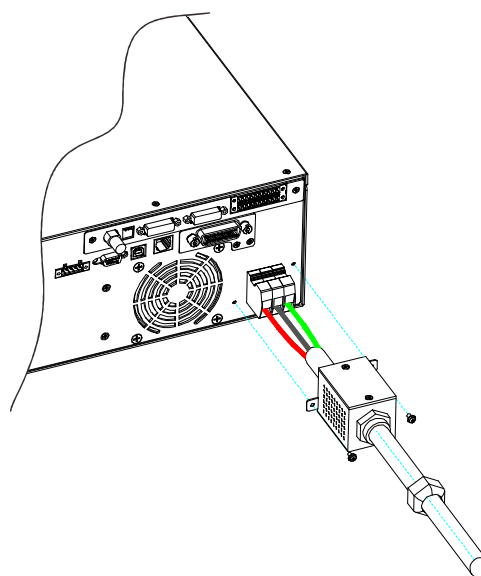

8.6 Output Connection



Warning!

- Be sure to disconnect from AC before access to AC output and AC input compartment.
- Approved flexible cords with double insulation, suitable size, min. 60 deg C as in the following table must be used as power output.
- Use certified type double insulated wire or cord of 18~25 mm in diameter.

Model	Wire Size	Model	Wire Size
ACPS600W	1.6 mm ² /14 AWG	ACPS3000W	4 mm ² /6 AWG
ACPS1000W	2 mm ² /12 AWG	ACPS4000W	4 mm ² /6 AWG
ACPS1500W	2.5 mm ² /10 AWG	ACPS5000W	6 mm ² /3 AWG
ACPS2000W	2.5 mm ² /10 AWG		

1. Strip the outside insulation of the AC cable approximately 25mm. Strip 7mm of insulation from the end of each of the wires.
2. Loosen the plastic nut of the supplied cable strain relief clamp.
3. Pass the cable end including the line wire, neutral wire, and ground wire through the cable clamp and nut according to the direction of the drawing below, and then insert it into the line, neutral, and ground terminals respectively.
4. Using a suitably sized flat blade screwdriver tighten the screws on the top of terminal block assuring the wires are held tightly.
5. Replace and fasten the terminal cover box, and tighten the plastic nut of the cable strain relief clamp.

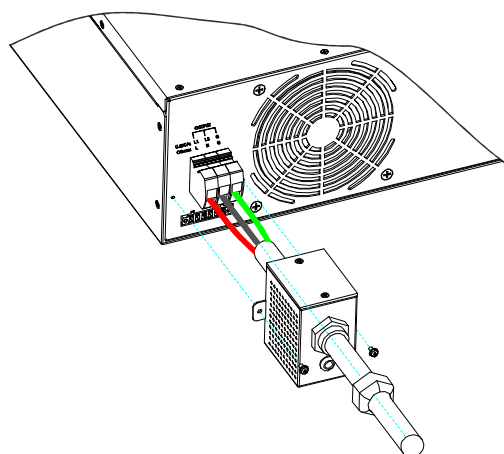

8.7 Remote Compensation

Remote sensing allows the power supply to automatically compensate for up to 5V voltage drop in the wires connected to the load.

1. For local sensing please refer to figure a. This method does not compensate for voltage drop on the load wires, therefore it is recommended only for low load currents, short connections to the load or where the load regulation is less critical.
2. Remote sensing, refer to figure b. Use remote sensing in application where load regulation at the load is critical. Remote sensing allows the power source to automatically compensate for voltage drop in the wires connecting the load.

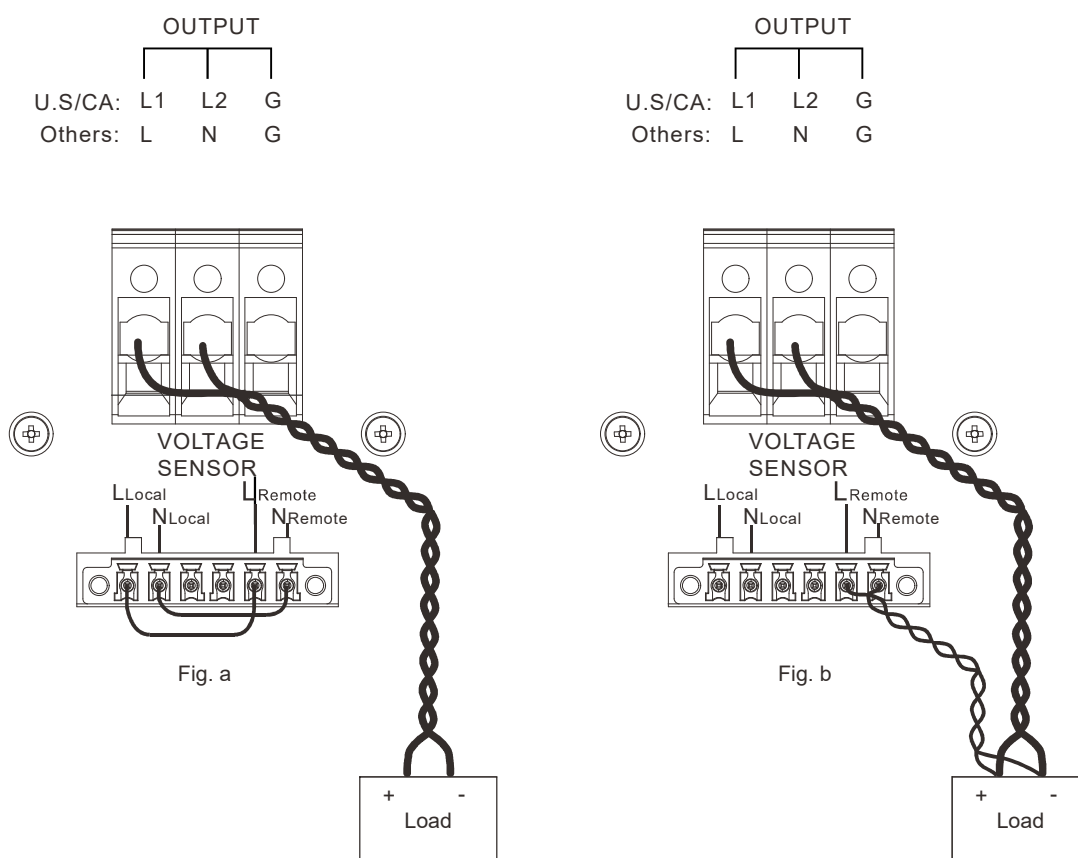

Chapter 9 : SCPI Communication Protocol

SCPI is a programmable language standard designed especially for programmable instruments. It defines how to communicate with the instruments from an external computer. The ACPS Series programmable AC power source uses SCPI programming language with two categories of commands: basic commands (IEEE-488.2 common commands), and ACPS programmable AC source commands. **Press the [Enter] key before sending each command. We use '-' to stand for a space in the commands.**

9.1 SCPI Command Descriptions

9.1.1 IEEE-488.2 Common Commands

These commands include common functions of IEEE-488.2. Common commands starting with *, regardless of hierarchy can be used.

***IDN?**

This command will request a download of information about the AC power source such as manufacturer, model number, series number and software version number.

9.1.2 Measurement Commands

Press the Enter (return) key before sending each command.

MEAS:VOLT?

This command queries the measurement of the total output voltage in volts RMS.

MEAS:VDC?

This command queries the measurement of the DC component of the output in volts.

MEAS:VAC?

This command queries the measurement of AC component of the output in volts.

MEAS:I?

This command queries the measurement of the total output current in amperes RMS.

MEAS:IDC?

This command queries the measurement of DC output current in amperes.

MEAS:IAC?

This command queries the measurement of AC output current in amperes.

MEAS:FREQ?

This command queries the measurement of the output frequency in Hertz (Hz).

MEAS:VPK?

This command queries the measurement of the peak output voltage in volts.

MEAS:IPK?

This command queries the measurement of peak current in amperes.

MEAS:CF?

This command queries the Crest Factor (CF).

MEAS:IS?

This command queries the measurement of output peak surge current (Is) in amperes.

MEAS:POWER?

This command queries the measurement of the output power in Watts (W).

MEAS:VAR?

This command queries the reactive power in VAR.

MEAS:VA?

This command queries the measurement of the apparent output power in VA.

MEAS:PF?

This command queries the output power factor (PF).

MEAS:ALL?

This command queries all the parameters in measurement fields.

The 16th parameter is the state of the output and 17th is the alarm code.

ASWRS?

This command queries alarm code.

ASWRC_0

This command clears alarm signals.

Alarm Code	Information	Instruction
0x0100	INNER LVP	Inner Under Voltage Protection
0x0080	INNER OVP	Inner Over Voltage Protection
0x0040	RCP	Reverse Current Protection
0x0020	SHT	Short Circuit Protection
0x0010	FAN	Fan Fault
0x0008	OTP	Over Temperature Protection
0x0004	OPP	Over Power Protection
0x0002	OCP	Over Current Protection
0x0001	OVP	Over Voltage Protection
0x0280	Frequency Over 1.2kHz	Input frequency BNC input > 1.2kHz
0x0210	Over range (mA)	Over Range mA current range
0x0208	Over range (low)	Over Range low current range
0x0204	Primary OCP	Primary Over Current Protection
0x0202	Primary OTP	Primary Over Temperature Protection
0x0201	Primary UVP	Primary Under Voltage Protection
0x0401	Mode Not Match	Modes for Master/Slave don't match
0x0402	Model Not Match	Model numbers are not the same
0x0404	No Phase B	Missing Phase Slave unit B
0x0408	No Phase C	Missing Phase Slave unit C
0x0410	Master Conflict	More than one Mater unit in system
0x0420	CAN No Slave	No salver unit found
0x0440	CAN No Master	No Master unit found
0x0480	Slave Conflict	More than one Slave with same number
0x0500	Slave offline	Slave Unit off line

9.1.3 Setting / Query Commands

OUTPUT:VAC: <NR2>

This command sets AC output voltage in volts. The setting range is 0.0~300.0V.
Return signal is OK or FALSE.

OUTPUT:VAC?

This command queries the AC output voltage in volts.

OUTPUT:VDC: <NR2>

This command sets DC output voltage in volts. The setting range is -424.2~424.2.
Return signal is OK or FALSE.

OUTPUT:VDC?

This command queries the DC output voltage in volts.

**OUTPUT:FREQ:_
<NR2>**

This command sets output frequency in Hertz (Hz).
The setting range is 15.00~1200.00 (Professional Version) or
15.00~1000.00 (Advanced Version).
Return signal is OK or FALSE.

OUTPUT:FREQ?

This command queries the frequency in Hertz (Hz).

OUTPUT:OUT:<STATE>

This command enables the output to be (ON) or disables the output (OFF), returns OK.

OUTPUT:OUT?

This command queries the output state, returns ON or OFF.

**OUTPUT:WAVEFORM:SELECT:_
<NR2>**

This command sets output waveform generator.
<NR2> A or B. Returns signal OK or FALSE.

OUTPUT:WAVEFORM:SELECT?

This command queries the waveform generator setting, A or B.

**OUTPUT:WAVEFORMA:_
<NR2>,<NR3>**

This command sets the parameters of waveform A. The return signal is OK or FALSE.

<NR2>	0 (SINE)	<NR3>	0~100.0
	1 (SQUA)		0~29
	2 (CSINE)		0~5
	3 (FIXED)		
	4 (USER)		

OUTPUT:WAVEFORMA?

This command queries the parameters of waveform A.

0	SINE
1	SQUA
2,60	CSINE, AMP=60%
3,4	FIXED, NO. 4
4,3	USER, NO. 3

**OUTPUT:WAVEFORMB:_
<NR2>,<NR3>**

This command sets the parameters of waveform B. The return signal is OK or FALSE.

<NR2>	0 (SINE)	<NR3>	0.0~100.0
	1 (SQUARE)		0~29
	2 (CSINE)		0~5
	3 (FIXED)		
	4 (USER)		

OUTPUT:WAVEFORMB?

This command queries the parameters of waveform B.

0	SINE
1	SQUARE
2,60	CSINE, AMP=60%
3,4	FIXED, NO. 4
4,3	USER, NO. 3

OUTPUT:ONDEGREE: _<NR2>

This command sets the start angle, the setting range is 0~359.9 degrees.

The return signal is OK or FALSE.

OUTPUT:ONDEGREE?

This command queries the start angle setting in degrees.

OUTPUT:OFFDEGREE: _<NR2>

This command sets the end angle, the setting range is 0~359.9 degrees, 360 degrees means DISABLE. The return signal is OK or FALSE.

OUTPUT:OFFDEGREE?

This command queries the end angle setting in degrees.

OUTPUT:SLEW:VOLT:AC: _<NR2>

This command sets the slew rate of the AC output voltage.

The setting range is 0.001V/ms~1200.000V/ms or 0 (Disable). Return signal is OK or FALSE.

OUTPUT:SLEW:VOLT:AC?

This command queries the slew rate of the AC output in V/ms.

OUTPUT:SLEW:VOLT:DC: _<NR2>

This command sets the slew rate of the DC output voltage in V/ms.

The setting range is 0.001~1000.000 or 0 (Disable). Return signal is OK or FALSE.

OUTPUT:SLEW:VOLT:DC?

This command queries the slew rate of the DC output in V/ms.

OUTPUT:SLEW:FREQ: _<NR2>

This command sets the slew rate of the frequency of the output waveform in Hz/ms.

The setting range is 0.001 Hz/ms~1600.000 Hz/ms or 0 (Disable).

The return signal is OK or FALSE.

OUTPUT:SLEW:FREQ?

This command queries the slew rate of the frequency of the output in Hz/ms.

OUTPUT:IMPED:FLAG: <NR2>

This command enables (ON) or disables (OFF) the output impedance function, the return signal is OK.

OUTPUT:IMPED:FLAG?

This command queries the state of output impedance, the return signal is ON or OFF.

OUTPUT:IMPED:RES: <NR2>

This command sets output resistance 'Zo_R'. The setting range is 0.01 ohm~1.00 ohm. The return signal is OK or FALSE.

OUTPUT:IMPED:RES?

This command queries the 'Zo_R' setting.

OUTPUT:IMPED:INDU: <NR2>

This command sets 'Zo_L'. The setting range is 0.01 mH~1.00 mH. The return signal is OK or FALSE.

OUTPUT:IMPED:INDU?

This command queries the Zo_L setting in mH.

OUTPUT:RANGE: <NR2>

This command sets the output range, 0(150V), 1(300V), 2(AUTO). The return signal is OK or FALSE.

OUTPUT:RANGE?

This command queries the output range setting, 0(150V), 1(300V), 2(AUTO).

OUTPUT:COUPLE: <NR2>

This command sets output coupling setting, 0(AC), 1(DC), 2(AC+DC). The return signal is OK or FALSE.

OUTPUT:COUPLE?

This command queries the output coupling setting. Return 0(AC), 1(DC), 2(AC+DC).

OUTPUT:IRANGE: <NR2>

This command sets the range of current measurement.

- 0 (High Range)
- 1 (Middle Range)
- 2 (Low Range)
- 3 (mA Range)
- 4 (Auto Range)

OUTPUT:IRANGE?

This command queries the range of current measurement.

- 0 (High Range)
- 1 (Middle Range)
- 2 (Low Range)
- 3 (mA Range)
- 4 (Auto Range)

OUTPUT:ISSTART: _<NR2>

This command sets the delay time of testing for surge current Is.
The setting range is 0.0~999.9ms. Return signal is OK or FALSE.

OUTPUT:ISSTART?

This command queries the delay time of testing for surge current Is in ms.

OUTPUT:ISINTERVAL: _<NR2>

This command sets the duration of testing for surge current Is.
The setting range is 0.0~999.9ms. Return signal is OK or FALSE.

OUTPUT:ISINTERVAL?

This command queries the setting of the duration of testing for Is in ms.

OUTPUT:RELAY: _<NR2>

This command sets the ON(1)/OFF(0) setting of the output relay.
Return signal is OK or FALSE.

OUTPUT:RELAY?

This command queries the setting of the output relay.
Return signal is 0 or 1.

9.1.4 Limit Commands

LIMIT:VAC: _<NR2>

This command sets the limit of AC output voltage. The setting range is 0~300.0 V.
Return signal is OK or FALSE.

LIMIT:VAC?

This command queries the limit setting of the AC output voltage.

LIMIT:VDC+: _<NR2>

This command sets the upper limit of the DC component of the output.
The setting range is 0~424.2V. Return signal is OK or FALSE.

LIMIT:VDC+?

This command queries the upper limit of the DC component of the output.

LIMIT:VDC: _<NR2>

This command sets the lower limit of the DC component of the output.
The setting range is 0~-424.2V. The return signal is OK or FALSE.

LIMIT:VDC-?

This command queries the lower limit of the DC component of the output.

LIMIT:FREQ: _<NR2>

This command sets the upper limit of output frequency in Hz.
The setting range is 15.00~1200.00 (Professional Version) or
15.00~1000.00 (Advanced Version).
Return signal is OK or FALSE.

LIMIT:FREQ?

This command queries the upper limit of output frequency in Hz.

LIMIT:OPP: _<NR2>

This command sets the limit of output power protection (OPP) in Watts.
The setting range is 30 ~ 1.02*Rated Power.
The return signal is OK or FALSE.

LIMIT:OPP?

This command queries the limit of OPP in Watts.

LIMIT:OCPLIMIT: _<NR2>

This command sets the level of over current protection (OCP).
The setting range is 0.2 ~ 1.02*Rated Current.
The return signal is OK or FALSE.

LIMIT:OCPLIMIT?

This command queries the level of the over current protection OCP in amperes.

LIMIT:OCPDELAY: _<NR2>

This command sets the delay time of OCP. The setting range is 0.0~5.0s.
The return signal is OK or FALSE.

LIMIT:OCPDELAY?

This command queries the delay time of OCP in second.

CCMODE: _<NR2>

This command enables (1) or disables (0) constant current CC mode.
The return signal is OK or FALSE.

CCMODE?

This command queries the state of CC mode. Return 1 or 0.

9.1.5 List Commands

LIST:BASE: _<NR2>

This command sets the base of current step. 0 (Cycle), 1 (Time).
The return signal is OK or FALSE.

LIST:COUNT: _<NR2>

This command sets the repeat times of the current step.
The setting range is 0~9999, 0 means infinite loop. The return signal is OK or FALSE.

LIST:CYCLE?

This command queries the repeat time of the current step at the moment.

LIST:DEGREE: _<NR2>

This command sets the start angle of the current step in degrees.
The setting range is 0.0~359.9 degrees. The return signal is OK or FALSE.

LIST:FREQEND: _<NR2>

This command sets the end frequency of the current step in Hz.
The setting range is 15.00~1200.00 (Professional Version) or
15.00~1000.00 (Advanced Version). The return signal is OK or FALSE.

LIST:FREQSTART: _<NR2>

This command sets the start frequency of the current step in Hz.
The setting range is 15.00~1200.00 (Professional Version) or
15.00~1000.00 (Advanced Version). The return signal is OK or FALSE.

LIST:LOAD

This command loads the file settings to the unit. The return signal is OK.

LIST:SAVE

This command saves the file settings to the unit. The return signal is OK.

LIST:MODE: _<NR2>

This command sets the running mode of the list file, 0 (Cont), 1 (Step).
The return signal is OK or FALSE.

LIST:RUN

This command runs the list file. The return signal is OK or FALSE.

LIST:STATUS?

This command queries the state of the list file, 0(Running), 1(Finished).

LIST:STEP?

This command queries the number of current step. Return 0~49.

LIST:STEPID: _<NR2>

This command sets the number of the current step. The setting range is 1~9.
Return signal is OK or FALSE.

LIST:STEPMODE: _<NR2>

This command sets the running mode of the current step, 0 (Cont), 1 (Step).
The return signal is OK or FALSE.

LIST:STEPNUM: _<NR2>

This command sets the total steps of this list file, the setting range is 1~9.
The return signal is OK or FALSE.

LIST:STOP

This command stops the running of the list file. The return signal is OK.

LIST:TIME: _<NR2>

This command sets the Time of the current step. The setting range is 0.0~9999999.9.
The return signal is OK or FALSE.

LIST:VACEND: _<NR2>

This command sets the end AC voltage of the current step in volts.
The setting range is 0.0~300.0V. The return signal is OK or FALSE.

LIST:VACSTART: _<NR2>

This command sets the start AC voltage of the current step in volts.
The setting range is 0.0~300.0V. The return signal is OK or FALSE.

LIST:VDCEND: _<NR2>

This command sets the end DC voltage of the current step in volts.
The setting range is -424.2~424.2V. The return signal is OK or FALSE.

LIST:VDCSTART: _<NR2>

This command sets the start DC voltage of the current step in volts.
The setting range is -424.2~424.2V. The return signal is OK or FALSE.

LIST:WAVEFORM: _<NR2>

This command sets the waveform generator, A or B. The return signal is OK or FALSE.

SEQ:CYCLE: _<NR2>

This command sets the repeat time of the sequence. The setting range is 1~9999.
The return signal is OK or FALSE.

SEQ:CYCLE?

This command queries the repeat time of the current list in the sequence at the moment.
Return 1~9999.

SEQ:LISTCYCLE?

This command queries the repeat time of the current step in the list file at the moment.
Return 0~9999.

SEQ:LISTID: _<NR2>

This command chooses the number of the list file. The setting range is 1~50.
The return signal is OK or FALSE.

SEQ:LOAD

This command loads the sequence settings to the unit. Return OK.

SEQ:RUN

This command runs the sequence file. Return OK.

SEQ:STATUS?

This command queries the state of the sequence file, 0 (Running), 1 (Finished).

SEQ:STEP?

This command queries the number of the current step of the sequence.

SEQ:STEPCOUNT: _<NR2>

This command sets the number of loop cycle of the current step.
The setting range is 0~9999, 0 means infinite loop. The return signal is OK or FALSE.

SEQ:STEPNUM: _<NR2>

This command sets the total steps of the sequence. The setting range is 1~50.
The return signal is OK or FALSE.

9.1.6 Pulse Commands

PULSE:CYCLE: _<NR2>

This command sets the repeat times of the pulse.
The setting range is 0~65535, 0 means infinite loop.
The return signal is OK or FALSE.

PULSE:DEGREE: _<NR2>

This command sets the start angle of the pulse in degrees. The setting range is 0.0~359.9.
The return signal is OK or FALSE.

PULSE:DUTYCYCLE: _<NR2>

This command sets the duty cycle of the pulse. The setting range is 0.0~100.0 (%).
The return signal is OK or FALSE.

PULSE:FREQ: <NR2>

This command sets the frequency of the pulse.
The setting range is 15.00~1200.00Hz (Professional Version) or
15.00~1000.00Hz (Advanced Version).
The return signal is OK or FALSE.

PULSE:PERIOD: <NR2>

This command sets the cycle time of the pulse in ms. The setting range is 0~9999999.9 ms.
The return signal is OK or FALSE.

PULSE:REMAINTIME?

This command queries the remaining time of the pulse mode in seconds. The setting range is
0.0~6553434465.

PULSE:START: <NR2>

This command sets when to run pulse waveform in ms. The setting range is 0.0~25.0.
The return signal is OK or FALSE.

PULSE:TRIGGER

This command runs the pulse waveform. Return OK.

PULSE:STOP

This command stops the running of pulse waveform. Return OK.

PULSE:VAC: <NR2>

This command sets AC voltage in volts. The setting range is 0.0~300.0.
The return signal is OK or FALSE.

PULSE:VDC: <NR2>

This command sets DC voltage in volts. The setting range is -424.2~424.2.
The return signal is OK or FALSE.

PULSE:WAVEFORM: <NR2>

This command chooses the waveform generator, A or B. The return signal is OK or FALSE.

9.1.7 Step Commands

STEP:COUNT: <NR2>

This command sets the step times.
The setting range is 0~9999, 0 means infinite loop. The return signal is OK or FALSE.

STEP:DEGREE: <NR2>

This command sets the start angle of the pulse in degrees. The setting range is 0.0~359.9.
The return signal is OK or FALSE.

STEP:DFREQ: <NR2>

This command sets the step value of frequency in Hz.
The setting range is 15.00~1200.00 (Professional Version) or 15.00~1000.00 (Advanced Version).
The return signal is OK or FALSE.

STEP:DVAC: <NR2>

This command sets the step value of AC output voltage in volts.
The setting range is -300.0~300.0. The return signal is OK or FALSE.

STEP:DVDC: <NR2>

This command sets the step value of DC output voltage in volts.
The setting range is -424.2~424.2. The return signal is OK or FALSE.

STEP:DWELL: <NR2>

This command sets the duration of each step in ms.
The setting range is 0~9999999.9ms. The return signal is OK or FALSE.

STEP:FREQ: <NR2>

This command sets the start frequency.
The setting range is 15.00~1200.00 (Professional Version) or 15.00~1000.00 (Advanced Version). The return signal is OK or FALSE.

STEP:MAXPOWER:FREQ?

This command queries the frequency of the maximum power point in Hz.

STEP:MAXPOWER:I?

This command queries the current of the maximum power point in amperes.

STEP:MAXPOWER:P?

This command queries the power of the maximum power point in watts.

STEP:MAXPOWER:PF?

This command queries the PF of the maximum power point.

STEP:MAXPOWER:V?

This command queries the voltage of the maximum power point in volts.

STEP:PAUSE

This command pauses or re-run the file. Return OK.

STEP:POWERSWEEP: <NR2>

This command enables (1) or disables (0) the sweep function.

STEP:REMAINTIME?

This command queries the remaining time of the Step file in seconds.

STEP:TRIGGER

This command runs the Step file. Return OK.

STEP:STOP

This command stops the Step file. Return OK.

STEP:VAC: _<NR2>

This command sets the start AC voltage in volts. The setting range is 0~300.0V.

STEP:VDC: _<NR2>

This command sets the start DC voltage in volts. The setting range is -424.2~424.2V.

STEP:WAVEFORM: _<NR2>

This command sets the waveform generator, A or B. The return signal is OK or FALSE.

9.1.8 Synthesis Commands

SYNTHESIS:COMPOSE: _<NR2>

This command sets compose as 0 (Value) or 1 (Percent). The return signal is OK or FALSE.

SYNTHESIS:DEGREE: _<NR2>

This command sets the start angle of the pulse in degrees. The setting range is 0.0~359.9.
The return signal is OK or FALSE.

SYNTHESIS:F: _<NR2>

This command sets frequency as 0 (50Hz) or 1 (60Hz). The return signal is OK or FALSE.

SYNTHESIS:PHASE: _<NR2>,<NR3>

This command sets the phase angle for each harmonic.

<NR 2>: 2~40

<NR 2>: 0.0~359.9

The return signal is OK or FALSE.

SYNTHESIS:TRIGGER

This command runs the Synthesis file.

Return OK.

SYNTHESIS:STOP

This command stops the running of the Synthesis file.

Return OK.

SYNTHESIS:V:_<NR2>,<NR3>

This command sets the amplitude for each harmonic.

<NR 2>: 2~40

<NR 3>: see the form below.

N	2~10	11~20	21~30	31~40
Value	0.0~150.0V	0.0~120.0V	0.0~80.0V	0.0~45.0V
Percent	(0.0~100.0%)*Vac	(0.0~50.0%)*Vac	(0.0~30.0%)*Vac	(0.0~15.0%)*Vac

Note: Vac is the fundamental voltage. Percent actually is the value multiplied by fundamental voltage.

The return signal is OK or FALSE.

SYNTHESIS:VAC:_<NR2>

This command sets fundamental AC voltage in volts.

0.0~150.0 (150V Range) or 0.0~300.0 (300V Range).

The return signal is OK or FALSE.

SYNTHESIS:VDC:_<NR2>

This command sets fundamental DC voltage in volts.

-212.1~212.1 (150V Range) or -424.2~424.2 (300V Range).

The return signal is OK or FALSE.

SYNTHESIS:PHASE:ALL:_<NR2>

This command sets the phase angle for all harmonics.

<NR 2>: 0.0~359.9

The return signal is OK or FALSE.

SYNTHESIS:V:ALL:_<NR2>

This command sets the amplitude for all harmonics.

<NR 2>: see the form below.

N	2~10	11~20	21~30	31~40
Value	0.0~150.0V	0.0~120.0V	0.0~80.0V	0.0~45.0V
Percent	(0.0~100.0%)*Vac	(0.0~50.0%)*Vac	(0.0~30.0%)*Vac	(0.0~15.0%)*Vac

Note: Vac is the fundamental voltage. Percent actually is the value multiplied by fundamental voltage.

The return signal is OK or FALSE.

9.1.9 Inter-harmonics Commands**INTER:NORMAL:VAC:_<NR2>**

This command sets the fundamental voltage. The setting range is 0.0~300.0V.

The return signal is OK or FALSE.

INTER:NORMAL:FREQ:_<NR2>

This command sets the fundamental frequency.

The return signal is OK or FALSE.

INTER:START:FREQ: <NR2>

This command sets the start frequency. The setting range is 0.01~2400Hz.
The return signal is OK or FALSE.

INTER:END:FREQ: <NR2>

This command sets the end frequency. The setting range is 0.01~2400Hz.
The return signal is OK or FALSE.

INTER:LEVEL: <NR2>

This command sets the inter-harmonics value the percentage of fundamental voltage.
The setting range is 0.0~100.0. The return signal is OK or FALSE.

INTER:DWELL:TIME: <NR2>

This command sets the running time of inter-harmonics file.
The setting range is 0.01~9999.99s. The return signal is OK or FALSE.

INTER:ALL: <NR2>

This command sets all the 6 parameters in this mode at the same time, separated by commas.
The return signal is OK or FALSE.

9.1.10 Harmonics Measurement Commands

HARMONICS:MEASURE:FLAG?

This command queries the state of the measurement.
The return signal is 0 (unfinished) or 1 (finished).

HARMONICS:MEASURE:RUN

This command runs the measurement of the harmonics.
The return signal is OK.

HARMONICS:MEASURE:STOP

This command stops the measurement of the harmonics.
The return signal is OK.

HARMONICS:MEASURE:FREQ: <NR2>

This command sets the measurement frequency of the harmonics, 0 (50Hz) and 1 (60Hz).
The return signal is OK or FALSE.

HARMONICS:MEASURE:TIMES: <NR2>

This command sets the measurement times of the harmonics, 0 (Single) and 1 (Continue).
The return signal is OK or FALSE.

HARMONICS:MEASURE:SOURCE: <NR2>

This command sets the measurement source of the harmonics, 0 (Voltage) and 1 (Current).
The return signal is OK or FALSE.

HARMONICS:MEASURE:ALL?

This command queries all the 41 harmonics parameters, separated by commas.

9.1.11 Master-slave Mode Commands

PARA:SLAVEA:VOLT?

This command queries the RMS voltage of slave 1 in volts.

PARA:SLAVEA:CURR?

This command queries the RMS current of slave 1 in amperes.

PARA:SLAVEA:POWER?

This command queries the output power of slave 1 in watts.

PARA:SLAVEA:VDC?

This command queries the DC output voltage of slave 1 in volts.

PARA:SLAVEB:VOLT?

This command queries the RMS voltage of slave 2 in volts.

PARA:SLAVEB:CURR?

This command queries the RMS current of slave 2 in amperes.

PARA:SLAVEB:POWER?

This command queries the output power of slave 2 in watts.

PARA:SLAVEB:VDC?

This command queries the DC output voltage of slave 2 in volts.

PARA:SLAVEC:VOLT?

This command queries the RMS voltage of slave 3 in volts.

PARA:SLAVEC:CURR?

This command queries the RMS current of slave 3 in amperes.

PARA:SLAVEC:POWER?

This command queries the output power of slave 3 in watts.

PARA:SLAVEC:VDC?

This command queries the DC output voltage of slave 3 in volts.

PARA:SUM:VOLT?

This command queries the RMS voltage of this system in volts.

PARA:SUM:CURR?

This command queries the RMS current of this system in amperes.

PARA:SUM:POWER?

This command queries the output power of this system in watts.

PARA:NUM?

This command queries the number of slaves.

The return signal is 0~3.

PARA:MODE?

This command queries the connection modes.

Return values are:

- 0 (Single Mode)
- 1 (Parallel Mode)
- 2 (Series Mode)
- 3 (Link output for 3-Phase)

PARA:FREQ?

This command queries the frequency in Hertz (Hz).

PARA:SLAVEA:ALL?

This command queries the measurement parameters of slave 1.

PARA:SLAVEB:ALL?

This command queries the measurement parameters of slave 2.

PARA:SLAVEC:ALL?

This command queries the measurement parameters of slave 3.

PARA:MASTER:ALL?

This command queries the measurement parameters of the Master unit.

PARA:PHASEB:VAC: _<NR2>?

This command sets the AC output voltage of phase B in volts. Return OK or FALSE.

PARA:PHASEB:VDC: _<NR2>?

This command sets the DC output voltage of phase B in volts. Return OK or FALSE.

PARA:PHASEC:VAC: _<NR2>?

This command sets the AC output voltage of phase C in volts. Return OK or FALSE.

PARA:PHASEC:VDC: _<NR2>?

This command sets the DC output voltage of phase C in volts. Return OK or FALSE.

PARA:THREEPHASE:CONNECT: _<NR2>

This command sets the connect mode of this 3-phase system.

The setting range is 0~1. Returns OK or FALSE.

0	3 phase 4 wire (Wye configuration)
1	3 phase 3 wire (Delta configuration)

PARA:THREEPHASE:MODE: _<NR2>

This command sets the 3-phase output voltage mode.

The setting range is 0~1. Returns OK or FALSE.

0	3-phase voltage follows the master
1	Each phase voltage can be set individually

9.1.12 Dimmer Function Commands

SYS:DIM:EDGE: _<NR2>

This command sets the edge of the dimmer.

The setting range is 0~1. Return OK or FALSE.

0	Leading edge
1	Trailing dege

SYS:DIM:DEGREE: _<NR2>

This command sets the phase angle of the blanking period.

The setting range is 0.0~180.0. Return OK or FALSE.

9.1.13 System Commands

SYS:RECALLDEFAULT

This command recalls factory default setting. Returns OK.

SYS:LOC

This command enables the local operation. Returns OK.

SYS:RECALLIP

This command resets the IP address setting of the unit. Returns OK.

9.1.14 External Control Mode Commands

EXTERN:CONTROLMETHOD: <NR2>

This command sets the external control mode. Returns OK or FALSE.

0	Amplifier Mode
1	Level Mode
2	Voltage Set Mode

EXTERN:CONTROLMETHOD?

This command queries the external control mode.

0	Amplifier Mode
1	Level Mode
2	Voltage Set Mode

EXTERN:VOLTAGE: <NR2>

This command sets the voltage set of external control. The setting range is 3V, 5V or 10V.

EXTERN:VOLTAGE?

This command queries the voltage set of external control. Returns value is 3V, 5V or 10V.

Chapter 10 : Troubleshooting

Problem	Causes	Solutions
The screen shows the message C001 PRI_OTP.	Primary temperature is too high.	Contact us for technical support
The screen shows the message C002 PRI_OCP.	Input over current.	Contact us for technical support
Black screen.	Input over voltage.	Turn off the output and check the AC input to ensure the voltage can meet the requirement.
The screen shows the message C004 PRI_UVP.	Input under voltage.	Turn off the output and check the AC input to ensure the voltage can meet the requirement.
The screen shows the message C005 BUS_UVP.	Bus over current.	Contact us for technical support
The screen shows the message C006 USB_OCP.	USB over current.	Check the USB memory and USB interface on the front panel.
The screen shows the message C007 DISPLAY EEPROM FAIL.	Display memory error.	Contact us for technical support
The screen shows the message C008 DSP COMM. FAIL	Internal memory error.	Contact us for technical support
The screen shows the message C009 OUTPUT OVP.	Output over voltage.	Check the output voltage range.
The screen shows the message C010 OUTPUT OCP.	Output over current.	Adjust the setting range of the current, or the OCP setting.

Problem	Causes	Solutions
The screen shows the message C011 OUTPUT OPP.	Output over power.	Adjust the OPP setting.
The screen shows the message C012 SEC OTP	Secondary temperature is too high.	Contact us for technical support
The screen shows the message C013 FAN ALARM	Fan failure.	Contact us for technical support
The screen shows the message C014 SHORT ALARM	Output wires are short-circuited or the load connected to the power are short-circuited.	Turn off the output and check the cables to ensure they are properly connected before turning the power back on.
The screen shows the message C015 RCP ALARM	RCP circuit failure.	Contact us for technical support
The screen shows the message C016 OUTPUT 1 OVP	Remote compensation voltage exceeds 5V.	Make sure the remote compensation voltage is no more than 5V.
The screen shows the message Self Test Fail	Self-checking failure.	Contact us for technical support
The screen shows the message Unactivated	Activation failure.	Contact us for technical support

Chapter 11 : Dispatch procedure for service, E-Waste Management & Warranty

11.1 Dispatch procedure for service

No user serviceable parts are inside the instrument, should it become necessary to send back the instrument to factory for service, please observe the following procedure:

Before dispatching the instrument please write to us giving full details of the fault noticed.

1. After receipt of your communication, our service department will advise you whether it is necessary to send the instrument back to us for repairs or the adjustment is possible in your premises.
2. Dispatch the instrument (only on the receipt of our advice) securely packed in original packing duly insured and freight paid along with accessories and a copy of the fault details noticed at our Service Center or factory.

11.2 E-Waste

We support environmentally sustainable measures and solicit your cooperation in this endeavour by way of sending the equipment to us at the end of the life of the product. The equipment will be sent for recycling through authorised recyclers as per E-Waste Management Rules

Please write to us at support@scientificindia.com for this purpose. Your support will go a long way as each and everybody's action can lead to improve global environment.

11.3 Warranty

Scientific warrants all its Instruments to be free from defects in material and workmanship when used under normal operating conditions in accordance with the instructions given in the manual for a period of 12 (Twelve) months from date of purchase from Scientific or its authorized dealers. The service during the warranty period will be rendered on return to factory / service center basis.

1. Its obligation under this warranty is limited to repairing or replacing at its own discretion. This warranty shall not apply to any defect, failure or damage caused by accident, negligence, misapplication, alteration or attempt to repair, service or modify in any way.
2. This warranty does not include display, fuses, batteries or accessories. This warranty is only valid with the original purchaser who must have properly registered the product within 15 days from date of purchase. No other warranty is expressed or implied.
3. When it becomes necessary to return the instrument to our Factory facility, kindly pack it carefully in the original carton or equivalent and ship it duly insured, transportation charges prepaid.
4. Your Scientific instrument is a complex electronic device and deserves the best service available by technicians thoroughly familiar with its service and calibration procedures.