

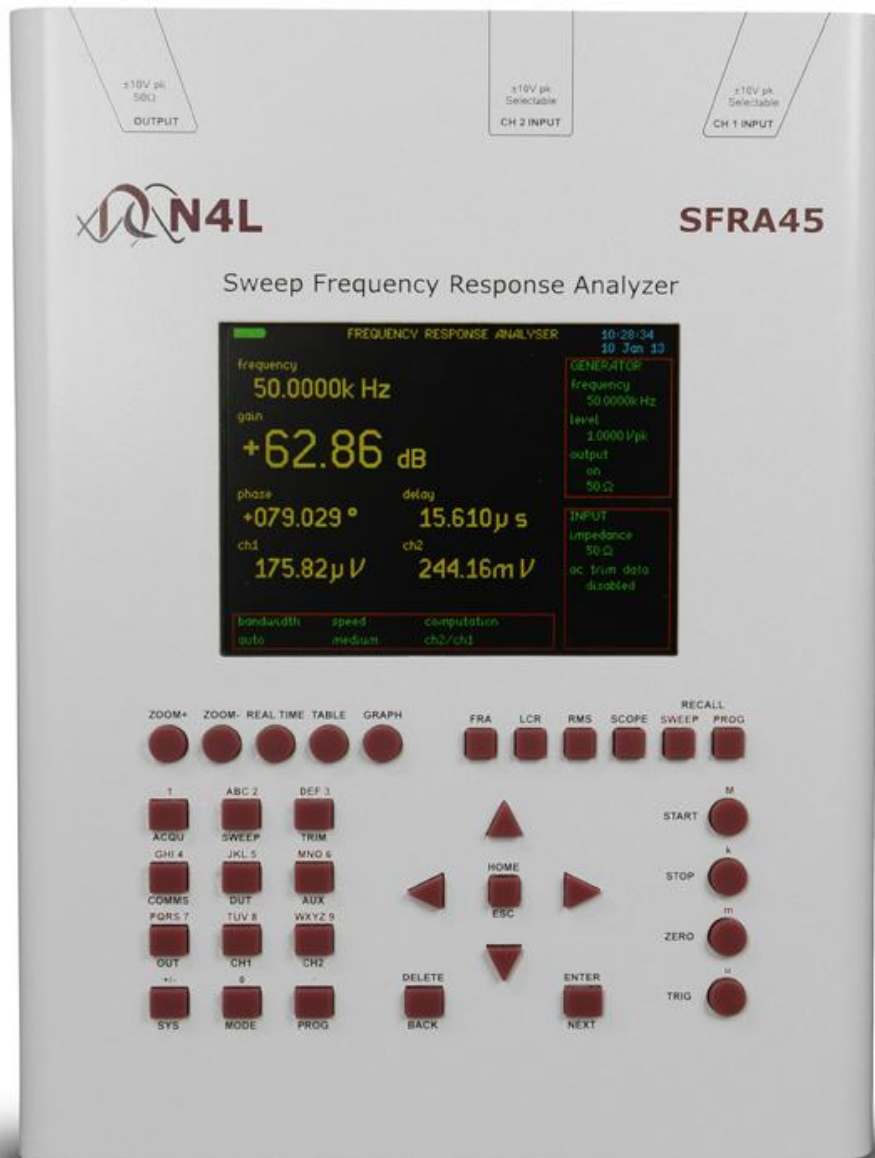

SFRA45

USER MANUAL

Version 2.10 November 2018



“Do not be hasty when making measurements.”

The SFRA455 is a precision instrument that provides you with the tools to make a wide variety of measurements accurately, reliably, and efficiently - but good metrology practice must be observed. Take time to read this manual and familiarise yourself with the features of the instrument in order to use it most effectively.

IMPORTANT SAFETY INSTRUCTIONS

This equipment is designed to comply with BSEN 61010-1 (2010) (Safety requirements for electrical equipment for measurement, control, and laboratory use) – observe the following precautions:

- Keep the ventilation holes on the underneath and rear free from obstruction.
- Do not operate or store under conditions where condensation may occur or where conducting debris may enter the case.
- There are no user serviceable parts inside the instrument – do not attempt to open the instrument, refer service to the manufacturer or his appointed agent.

Note: Newtons4th Ltd. shall not be liable for any consequential damages, losses, costs or expenses arising from the use or misuse of this product however caused.

DECLARATION OF CONFORMITY



We declare that the product:

Description: Sweep Frequency Response Analyser
Model: SFRA45

Conforms to the EEC Directives:

2014/30/EU relating to electromagnetic compatibility:
EN 61326-1:2013

2014/35/EU relating to Low Voltage Directive:
EN 61010-2-030:2010:

IP Protection of Inputs and Outputs: IP 30 – CEI EN
60529

Operating Temperature: -5° to 50° C

Storage Temperature: -10° to 60° C

Relative Humidity Range: 20-90% Non Condensing

Max Altitude: 2,000 Metres

Stuart Chappell
(Director Newtons4th Ltd.)

WARRANTY

This product is guaranteed to be free from defects in materials and workmanship for a period of 36 months from the date of purchase.

In the unlikely event of any problem within this guarantee period, first contact Newtons4th Ltd. or your local representative, to give a description of the problem. Please have as much relevant information to hand as possible – particularly the serial number and release numbers (press SYSTEM then LEFT).

If the problem cannot be resolved directly then you will be given an RMA number and asked to return the unit. The unit will be repaired or replaced at the sole discretion of Newtons4th Ltd.

This guarantee is limited to the cost of the instrument itself and does not extend to any consequential damage or losses whatsoever including, but not limited to, any loss of earnings arising from a failure of the product or software.

In the event of any problem with the instrument outside of the guarantee period, Newtons4th Ltd. offers a full repair and re-calibration service – contact your local representative. It is recommended that the instrument be re-calibrated annually.

ABOUT THIS MANUAL

This manual describes the general features, usage and specifications of the SFRA45 (Sweep Frequency Response Analyzer)

Detailed descriptions of the communications command set for RS232, USB and LAN is given in the separate manual "SFRA45" communications manual".

Version 2.1

5th November 2018

This manual is copyright © 2006 - 2018 Newtons4th Ltd. and all rights are reserved. No part may be copied or reproduced in any form without prior written consent.

SFRA45 User Manual

CONTENTS

1	Introduction – general principles of operation	1-1
2	SAFETY	2-1
3	Getting started	3-1
4	Quick Start guide	4-1
4.1	Operating Mode Keys.....	4-1
4.2	Menu Control Keys	4-2
4.3	Display Control Keys	4-3
4.4	Setup Keys/Keypad	4-4
4.5	Control Keys.....	4-5
4.6	Data Entry Guide	4-6
4.7	Power Transformer Mode	4-6
5	Using the menus	5-1
5.1	Selection from a list	5-3
5.2	Numeric data entry	5-4
6	Special functions	6-1
6.1	Display zoom.....	6-1
6.2	PROG – non volatile memory store and recall	6-1
6.3	Zero Compensation	6-3
6.4	Using Remote Control	6-5
6.5	Standard event status register.....	6-7
6.6	Serial Poll status byte	6-8
6.7	RS232 connections.....	6-9
6.8	RS232 printer	6-10
7	System options	7-1
7.1	User data	7-2
8	Setup / Key Functions.....	8-1
8.1	Acquisition Mode (ACQU)	8-1
8.2	Sweep Mode / Key (SWEEP)	8-3
8.3	Trim mode (TRIM).....	8-6
8.4	Comms Key (COMMS)	8-7
8.5	DUT Key	8-7

SFRA45 User Manual

8.6	AUX KEY	8-9
8.7	OUTPUT KEY.....	8-10
8.8	Input Channels	8-11
8.9	System Key Functions	8-14
8.10	Prog Key Functions.....	8-17
8.11	Storing Results	8-18
8.12	Recalling Results.....	8-20
8.13	Deleting Results.....	8-20
8.14	Memory Status	8-22
9	Frequency Response Analyzer.....	9-1
9.1	(FRA) Screen Display Areas.....	9-5
10	Impedance Mode.....	10-1
10.1	(LCR) Screen Display Areas.....	10-2
11	AC RMS Mode	11-1
12	Oscilloscope Mode.	12-1
13	Technical Specifications	13-1
14	Appendix A – Text File Format	13-2
14.1	Example Text File.....	14-2
14.2	Text File Header Format Explanation	14-3
14.3	Text File Example Sweep Data	14-4
	Appendix A – Contact details.....	14-6

SFRA45 User Manual

APPENDICES

Appendix A	Accessories
Appendix B	Serial command summary
Appendix C	Available character set
Appendix D	Configurable parameters
Appendix E	Contact details

SFRA45 User Manual

1 Introduction – General principles of operation

The SFRA45 Selective Level Meter is designed to provide a single instrument solution for multiple applications in the Power Transformer industry and specifically the Power Testing Systems environment. Features include:

- AC RMS Voltmeter
- Signal Generator
- Frequency Response Analyzer
- LCR Meter-Inductance, Capacitance, Resistance Measurement
- Oscilloscope

The SFRA45 has a wide bandwidth generator output that can be used as a signal generator for sine, square or triangular waveforms.

The SFRA45 has two high bandwidth voltage inputs, which use direct digital analysis at low frequencies and a heterodyning technique to give high accuracy at high frequencies. The voltage inputs are simultaneously sampled and the data is analysed in real time by high speed DSPs (digital signal processors). A separate CPU (central processing unit) takes the DSP results for display and communications. At the heart of the system is an FPGA (field programmable gate array) that interfaces the various elements.

The whole operation of the instrument may be controlled remotely via a serial interface (RS232/USB), or a LAN Interface. The programmable nature of the instrument means that new functions can be added as they become available, or existing functions can be enhanced, by simple firmware download.

Both the input channels are calibrated digitally so there are no physical adjustments to be made.

2 SAFETY

READ THIS GUIDE AND SAFETY INFORMATION BEFORE USING THE INSTRUMENT.

- Only use the instrument under the conditions and purpose for which it is intended.
- Ensure that the AC supply Voltage and the power pack supplied are at the same ratings. AC operation is intended for indoor use only.
- This instrument is NOT "field" repairable. Return the unit to Newtons4th Ltd for repair or replacement.
- The instrument is NOT waterproof or airtight. Return to the factory for evaluation if exposed to abnormal environmental conditions.
- Do not operate or store under conditions where condensation may occur or where conducting debris may enter the case.
- Keep the ventilation holes on the top and bottom ends of the instrument clear.
- **NOTE:** Operators should follow all standard and specific company safety procedures when using this product and accessories. Special precautions must be adhered to when working with or around antennas, power lines, radio frequency sources, etc. **FAILURE TO COMPLY WITH SAFETY RULES MAY RESULT IN INJURY OR DEATH.**

SFRA45 User Manual

3 Getting started

The SFRA45 is supplied ready to use – it comes complete with an appropriate power lead and a set of test leads. It is supplied calibrated and does not require anything to be done by the user before it can be put into service.



The instrument is housed in a rugged aluminium case and is provided with various accessories together as shown above.

SFRA45 User Manual

5.7" Colour Display to maximize Visibility in all conditions

Weight
2.7 Kgs
~5 lbs

Operates from an internal rechargeable Lithium Ion Battery, an AC/DC Power Source or an external 12V Vehicle Battery

Rugged metal casing ideal for field use

Tablet Style Dimensions
12" x 9" x 1.75"
305mm x 230mm x 45mm

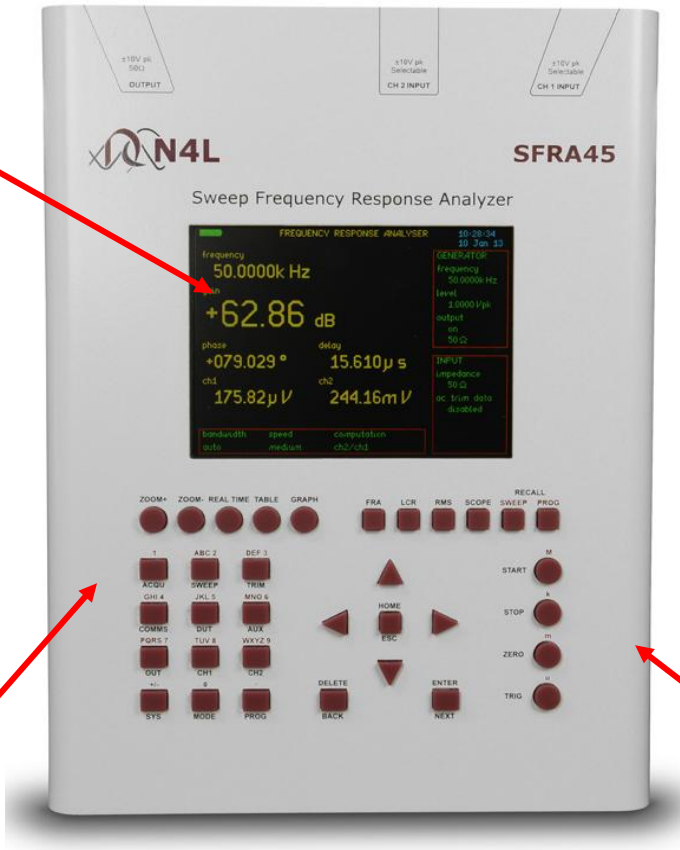

Further Features Include:

- Up to 1000 analyzer setups, readings and sweep results can be stored
- On board real time clock
- 6 digit freq, 5 digit volts and 4 digit dBm resolution
- Operational temperature range -5 to +50°C
- 1GB internal flash storage and ports. Many of the instrument test functions will provide the user with valuable information. Therefore 1 Gigabyte of memory, an external USB port and an RJ45 input connection for laptop connectivity provides a versatile solution for storage and communication.

The instrument can be powered by multiple sources; directly from the AC/DC Adapter, from the internal battery source (Lithium polymer batteries) or directly through the DC input, (9-18V @ 3A source required). The instrument is shipped with a 6-metre power adapter lead that permits use through a vehicle DC source outlet socket.

AC/DC Adapter – The AC/DC adapter can accept a wide AC input range (100 to 240Vac). Adapter plugs are available to accommodate the various country standards.

Battery Power – The instrument is shipped with a battery source consisting of (3) lithium polymer rechargeable batteries.

DC Input – The instrument is supplied with a 6-metre vehicle power adaptor lead. The vehicle DC source outlet socket can then be used to power and charge the instrument. The DC input will operate with a 9-18V dc source at 3A; however, the equipment warranty does not cover any damage caused by any other source than the ones provided with this instrument.

Charging the batteries – The instrument has a sophisticated battery monitoring and charging system, providing the user with a battery status indication. When running on battery power, the monitor goes from green to orange to red, indicating the state of the batteries. The instrument will beep and a prompt on the screen appears when power levels are at a stage when data or set-up information should be stored. When receiving the instrument it is recommended that the batteries are first charged and fully discharged two or three times to help extend battery life. Finally, fully charge the batteries before using the instrument.

The system provides the following indications while the batteries are charging:

SFRA45 User Manual

- When charging - blue with >>>>.
- When finished charging, but power connected- blank.
- If batteries get too hot, charging is suspended - red with XXXX

Changing the batteries - Only qualified personnel, trained and knowledgeable in electronic instrument repair and safety, having read this guide should attempt to change the batteries.

Disconnect the instrument from all external power sources. Remove the four (4) hex bolts from the sides of the instrument housing (2 on each side).

NOTE: Proper anti-static precautions should be used when opening the instrument, such as a grounding strap. Note the position and location of all ribbon cables. Disconnect ribbon cables as necessary to securely rest the instrument cover face down. Cut the tie-wraps holding the batteries in and remove all of the old batteries. **NOTE:** All three batteries should be replaced at the same time. Make sure disposal of the used batteries is in accordance with the local country regulations. Make sure the batteries are first charged and fully discharged two or three times to help extend battery life. Then finally fully charge the new batteries before using the instrument.

Communications – The instrument has communication interface ports supporting USB, RS232 and LAN options

Communication and Power Panel

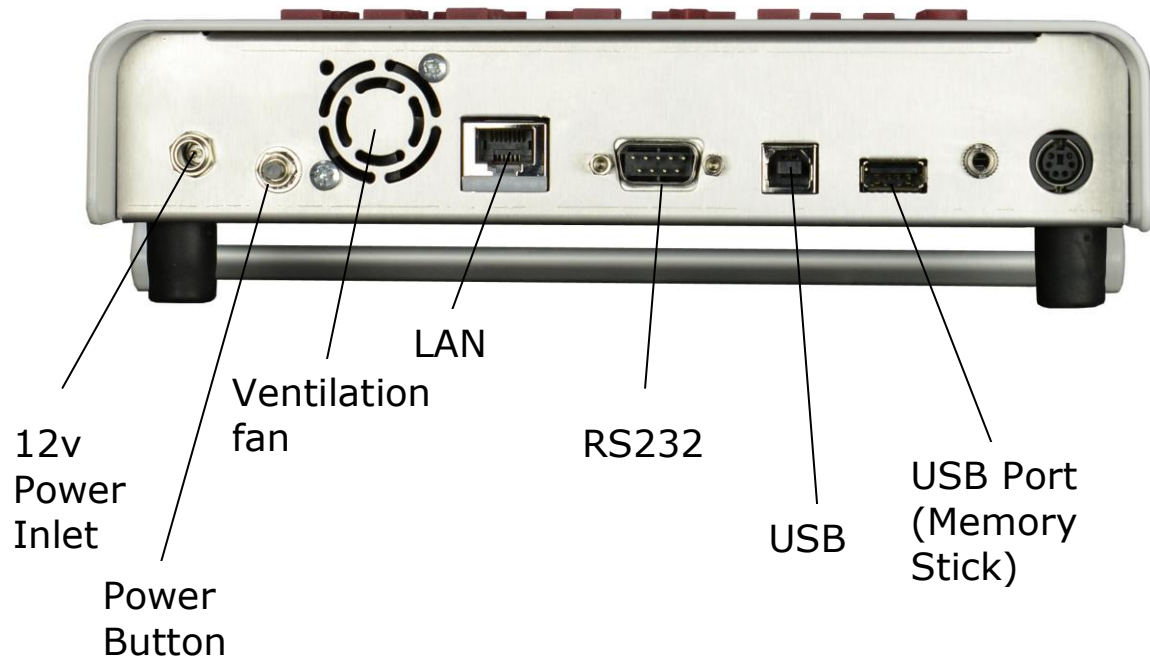

SFRA45 User Manual

Getting started with Initial Signal Capture

This may be the first time the instrument has been operated and therefore the user may not be familiar with the initial setup. This section provides guidance in order to capture signals which are unknown in amplitude.

- Switch on the SFRA45 unit. The display should illuminate with the model name and the firmware version for a few seconds while it performs initial tests. It should then default to the Frequency Response Analyzer (FRA) display.
- Select the RMS mode by pressing the "RMS" button
- Give the unit two minutes to warm up and then press the "ZERO" button
- Connect the output lead of the output BNC to CH1 and CH2 inputs.
- Press the OUT key to call up the output menu and set the output to ON. Set the output amplitude to 2V. Exit the menu by pressing the ENTER button or the HOME Button twice.
- The display should indicate an RMS value of around 470mV (Input Impedance set to 50 Ohms)
- Press the "FRA" key to select the frequency response and check the gain reads $0.000\text{dB} \pm 0.010\text{dB}$, and that the phase reads $0.000^\circ \pm 0.010^\circ$

In the event of any problem with this procedure, please contact customer services at Newtons4th Ltd. or your local authorised representative: contact addresses and telephone numbers are given in the appendix at the back of this manual.

4 Quick Start guide

4.1 Operating Mode Keys



The operating Mode Keys: FRA, LCR, RMS, SCOPE allow direct access to the main operating modes of the instrument

FRA – Frequency Response Analyzer - Selects the *Frequency Response Analyzer* Mode.

LCR – Impedance Analyzer - Selects the *Impedance Analyzer* Mode.

RMS – AC RMS - Selects the *AC RMS* Mode.

Scope – Scope Mode

The factory default setting is the FRA Mode.

Press the operating mode key “FRA” etc a second time, or press the “MODE” key, to access mode-specific options

4.2 Menu Control Keys

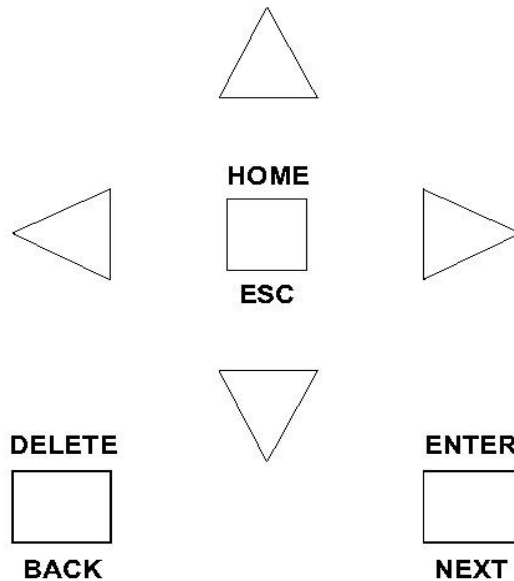

ENTER/NEXT confirms your selection or parameter value/data entry.

HOME/ESC returns to the original entry or to your previous action.

DELETE/BACK removes a previous selection or value, or returns to your previous action.

ARROW KEYS (Up, Down, L, R) to move around menu options, make incremental/decremental changes etc. Also to position cursors in **SCOPE** mode.

SFRA45 User Manual

4.3 Display Control Keys



Display Zoom

- a. Return to no zoom by pressing ZOOM-
- b. Press ZOOM+ to zoom in

Real time

Toggles between continuous display readings and Table graphs.

Table, Graph

Select tabular or graphical presentation of sweep data

4.4 Setup Keys/Keypad

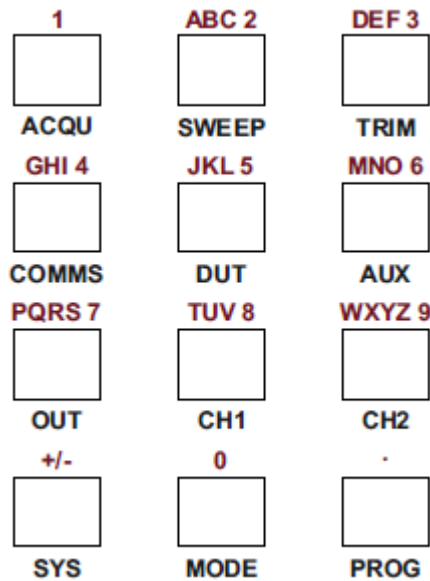

SELECT MENUS for non mode-specific configuration. Also, use as numeric keypad when entering parameter values or data.

ACQU	Data acquisition parameters (speed, filtering)
SWEEP	Frequency Sweep Control
TRIM	Generator Trim Control
COMMS	Communications Option
OUT	Signal Generator Control
CH1	Channel 1 Input Control
CH2	Channel 2 Input Control
SYS	General Systems Options
MODE	Function Control
PROG	Recall / Store / Delete of non-volatile programs

FOR NUMERIC ENTRY see DATA ENTRY GUIDE

4.5 Control Keys

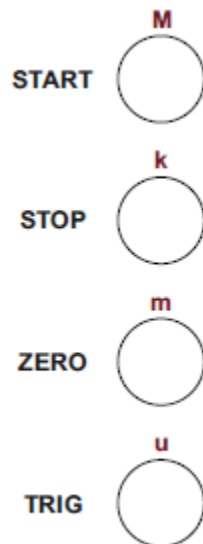

START & STOP (used for Sweeps). Either key also triggers single-shot in **SCOPE** mode.

Use **ZERO** key for:

- LCR Mode provides zero compensation information and is used to remove the capacitive element of test leads from the measured impedance.
- FRA Mode provides 0dB reference and dB calculation information

TRIGGER (or START) returns display to Real Time from Hold. Also triggers single-shot in **SCOPE** mode.

The four circular keys on the right have a second function. The letter above each key is a numeric multiplier 'M' for mega, 'K' for kilo, 'm' for milli and 'μ' for micro. When entering large or small numbers these multipliers may be used to save key strokes.

4.6 Data Entry Guide

TEXT ENTRY

Text entry can be made via the numerical keypad resembling a telephone keypad. Key 1 is symbols, key 2 ABC, key 3 DEF etc.

NUMERIC ENTRY

Use **MODE/ENTRY KEYS** for number, multiplier, decimal point, or +/- to enter parameter value.

Press ENTER (**MENU CONTROL KEYS**) to set value.

Press HOME (**MENU CONTROL KEYS**) to abort data entry, restore original.

(Values may be overwritten, or edited by use of the R, L and DELETE keys)

4.7 Testing a Power Transformer (Example)

The SFRA45 includes a "Power Transformer mode" which fully complies with IEC60076-18. This ensures that all necessary parameters and information are recorded on the instrument without the requirement for a PC. The default settings when the instrument is turned on are intended to provide the user with as few steps as possible in order to begin testing.

Initial Start Up Screen

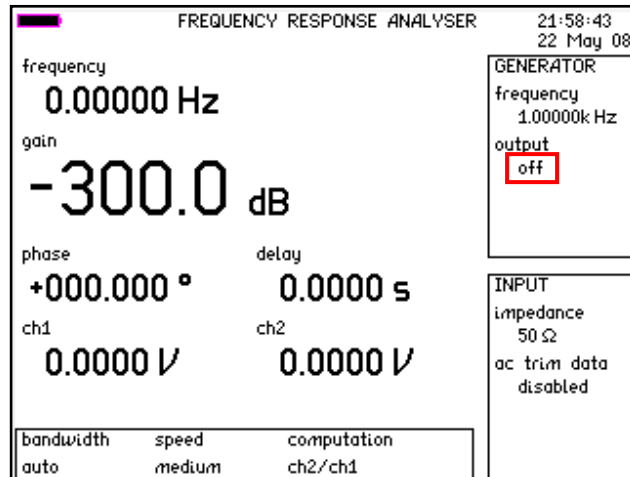

When the unit is first turned on, the generator will be off.

Configure Inputs

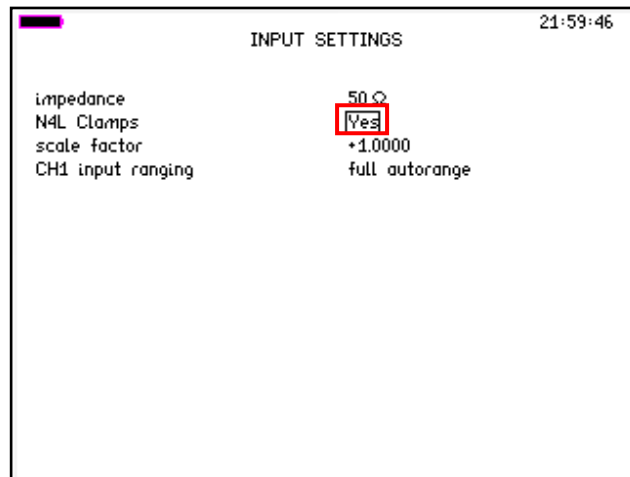

By pressing "**INPUT**" we can view/edit the input settings. The default settings for are an input impedance of 50 Ohms, which should be left the same. The N4L Clamps parameter will be set to "No" If you are using the N4L clamp set, set this to "Yes"

Check Sweep Parameters

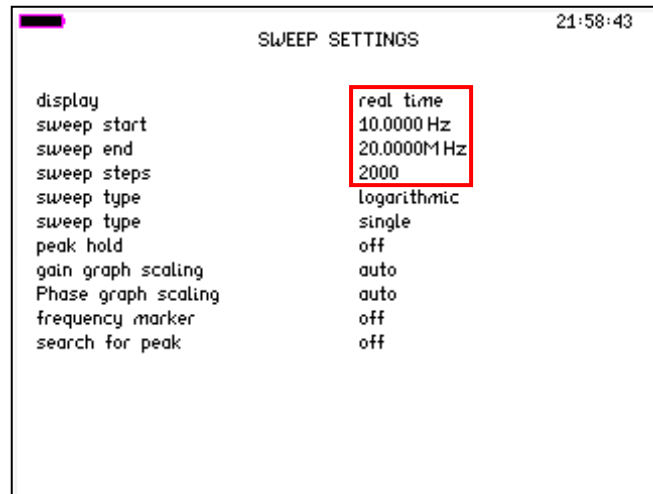

Pressing the "**SWEEP**" button opens the sweep menu, default sweep parameters have been chosen to satisfy a typical transformer test. These can be changed as per the user preference.

Remote communication port settings

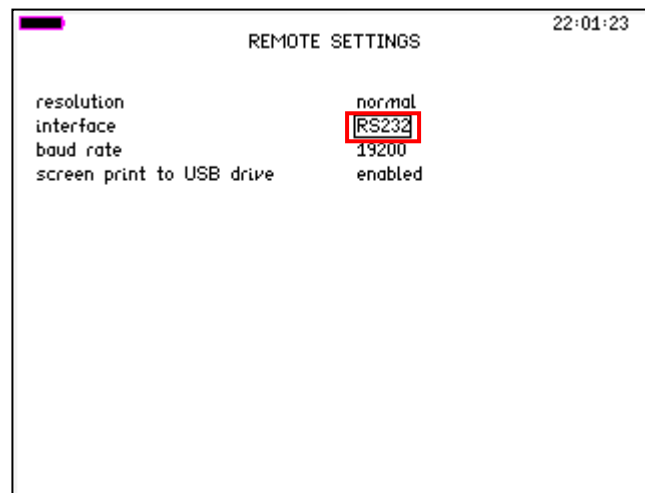

If you are using the unit in conjunction with SFRAComm software, pressing the "**COMMS**" key will reveal the communication menu, the unit should be set as per your communication interface. The options are USB, RS232 and LAN.

Turn Generator ON

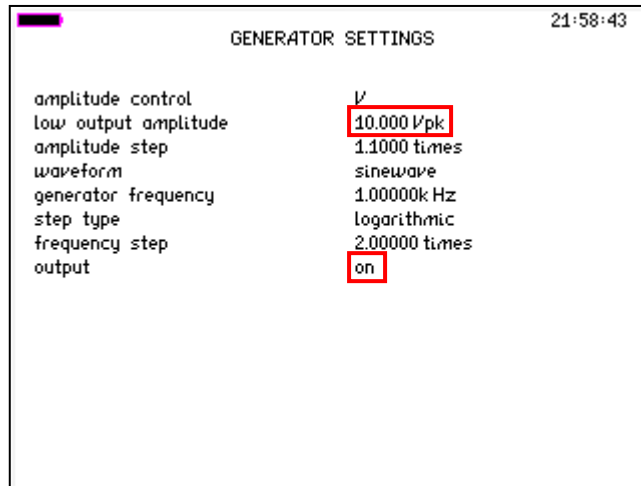

Pressing the “OUTPUT” menu will enable you to change the generator settings and turn the generator on. The default generator signal level is 10Vpk, the generator can be turned on in this menu. It is advisable to connect to the transformer winding before activating the generator in order to prolong battery life.

Loading a Reference Sweep

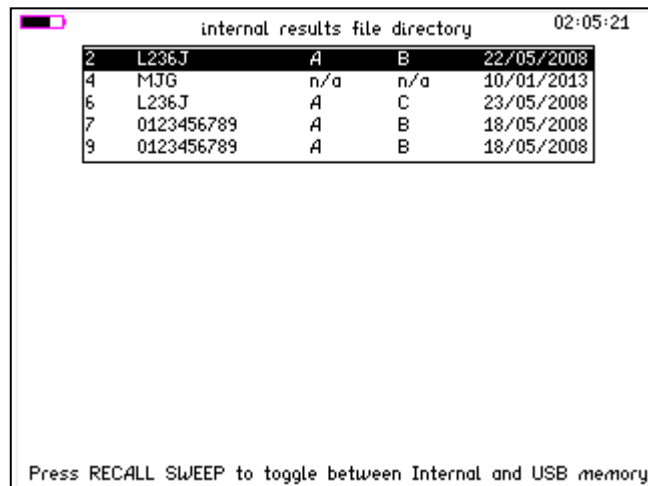

Pressing the “**SWEEP RECALL**” button to the far top right of the keypad will open the file directory. Pressing again will toggle between the external USB memory stick memory and the internal memory.

SFRA45 User Manual

(Note that 2GB is the maximum allowable size of USB memory stick that can be used)

By Pressing "**ENTER**" on the selected sweep (Selected using the **UP** and **DOWN** arrow keys) the sweep data will be loaded including all sweep/acquisition settings.

5 Using the menus

The SFRA45 is a very versatile instrument with many configurable parameters. These parameters are accessed from the front panel via a number of menus shown in the table below

ACQU	Data acquisition parameters (speed, filtering)
SWEEP	Frequency Sweep Control
TRIM	Generator Trim Control
COMMS	Communications Option
OUT	Signal Generator Control
CH1	Channel 1 Input Control
CH2	Channel 2 Input Control
SYS	General Systems Options
MODE	Function Control
PROG	Recall / Store / Delete of non-volatile programs

Each menu starts with the currently set parameters visible but no cursor. In this condition, pressing the menu key again or the HOME key aborts the menu operation and reverts back to normal operation.

To select any parameter, press the UP or DOWN key and a flashing box will move around the menu selecting each parameter. In this condition the keys take on their secondary function such as numbers 0-9, multipliers n-G etc.

SFRA45 User Manual

Pressing the HOME key first time reverts to the opening state where the parameters are displayed but the cursor is hidden. Pressing the HOME key at this point exits the menu sequence and reverts back to normal operation.

To abort the menu sequence, press the HOME key twice.

There are three types of data entry:

- selection from a list

- numeric

- text

5.1 Selection from a list

This data type is used where there are only specific options available such as the smoothing may be 'normal', 'slow', or 'none', the graph drawing algorithm may use 'dots' or 'lines'.

When the flashing cursor is highlighting the parameter, the RIGHT key steps forward through the list and the LEFT key steps backwards through the list. The number keys 0-9 step directly to that point in the list, which provides a quick way to jump through long lists. There is no need to press the ENTER key with this data type

For example, if the smoothing selection list comprises the options:

normal	(item 0)
slow	(item 1)
none	(item 2)

and the presently selected option is normal, there are 3 ways to select none:

- press RIGHT two times
- press LEFT once
- press number 2

5.2 Numeric data entry

Real numbers are entered using the number keys, multiplier keys, decimal point key, or +/- key (if signed value is permitted). When the character string has been entered, pressing the ENTER key sets the parameter to the new value. Until the ENTER key is pressed, pressing the HOME key aborts the data entry and restores the original number.

If a data value is entered that is beyond the valid limits for that parameter then a warning is issued and the parameter set as close to the requested value as possible. For example, the minimum user-defined measurement window 10ms; if a value of 5ms is entered, a warning will be given and the amplitude set to the maximum of 10ms.

When the parameter is first selected there is no character cursor visible – in this condition, a new number may be entered directly and will overwrite the existing number.

To edit a data value rather than overwrite it, press the RIGHT key and a cursor will appear. New characters are inserted at the cursor position as the keys are pressed, or the character before the cursor position can be deleted with the DELETE key.

Data values are always shown in engineering notation to at least 5 digits (1.0000-999.99 and a multiplier).

6 Special functions

6.1 Display zoom

The SFRA45 normally displays results on the screen with a combination of small font size (no zoom) and in a larger font size.

6.2 PROG – non volatile memory store and recall

There are 3 types of data which can be saved in non-volatile locations:

- Programs
- Data log
- Measurement results

There are 1000 non-volatile program locations where the settings for the entire instrument can be saved for recall at a later date. Each of the 1000 locations has an associated name of up to 200 characters that can be entered by the user to aid identification.

Program number 1 (if not empty) is loaded when the instrument is powered on so that the SFRA45 can be set to a user-defined state whenever it is switched on. This is particularly useful to set system options such as phase convention. If no settings have been stored in program 1 then the factory default settings are loaded (program number 0).

Program numbers 1-6 may be recalled with a single press of the function keys if the direct load option is selected in the system menu (see system options).

The instrument can be restored to the factory default settings at any time by recalling program number 0.

SFRA45 User Manual

The program menu is accessed using the PROG key. The program location can be selected either by stepping through the program locations in turn to see the name or by entering the program number directly.

When storing a configuration in a program, there will be a short pause of about 1 second if the program location had previously been written or deleted. The process will be very quick if the location has not been used.

When recalling a program it may be desirable for the program to recall the selected communications interface that was in use when the program was stored (RS232 or USB etc). Alternatively, it is more common for the communications interface to be associated with the instrument rather than a stored program. There is a selectable option in the REMOTE menu to enable the "recall with program". If this is "off" then recalling the program will not change the communications interface.

All file directory information can be displayed by pressing the "Prog" key and then the "Start" button. This will allow all the information to be displayed as a table and show what the internal file directory contains. (By pressing the "Start" button again exits the directory).

Data and files can also be stored and downloaded via a USB memory device. (Note that 2GB is the maximum allowable size of USB memory stick that can be used). When using a large capacity or slow device all the data may not be transferred within the transfer time window. If this happens it will be recognised and a display caption appears to prompt the user to press "any Key" to terminate the transfer when completed.

6.3 Zero Compensation

There are 2 levels of zero compensation:

Trim out the dc offset in the input amplifier chain.
Measure any remaining offset and compensate.

The trim of the dc offset in the input amplifier chain can be manually performed with the ZERO key, or over the RS232 with the REZERO command. This dc offset trim measures the dc present while the autozero switch is active and applies an equal and opposite offset via the D/A converter so that the input range to the A/D is optimised.

The measurement of the remaining offset also happens when the offset is trimmed but is also repeated at regular intervals. This is to compensate for any thermal drift in the amplifier chain.

Real-time measurement is not possible while the autozero measurement is in progress so this repeated autozero function can be disabled via the SYSTEM OPTIONS menu.

(LCR) mode provides zero compensation information and is used to remove the capacitive element of test leads from the measured impedance. Select "*compensate*" then Enter, to start zero compensation or, "*clear compensation*" then Enter to clear any previous compensation. The display shown below appears when the zero key is pressed. "DUT" means 'Device under Test', be sure to clear compensation before doing further testing.

ZERO COMPENSATION

To compensate for long connection leads when making impedance measurements, connect the cables to the instrument but leave them disconnected from the DUT.

Ensure that the disconnected terminals are not touching anything. Select the compensate option below and press ENTER.

compensate

In case you want to clear the compensation

Select the clear compensation option below and press ENTER.

clear compensation

(FRA) mode provides 0dB reference and dB calculation information. It is useful when looking for changes in gain under specific conditions such as where an attenuator -3dB cut off point occurs in relation to the 0dB reference.

SFRA45 User Manual

6.4 Using Remote Control

The SFRA45 is fitted with an RS232 serial communications port, a USB port and a LAN port as standard. All the interfaces use the same ASCII protocol

	Rx expects	Tx sends
RS232	carriage return	carriage return
USB	(line feed ignored)	and line feed
LAN		

All the functions of SFRA45 can be programmed via any of the interfaces, and results read back.

The commands are not case sensitive and white space characters are ignored (e.g. tabs and spaces). Replies from the SFRA45 are always upper case, delimited by commas.

Fields within a command are delimited by a comma, multiple commands can be sent on one line delimited with a semi-colon. Eg.

BANDW ,LOW;SPEED,SLOW

Mandatory commands specified in the IEEE488.2 protocol have been implemented, (e.g. *IDN?, *RST) and all commands that expect a reply are terminated with a question mark.

Data values returned by the SFRA45 are in scientific notation, with a 5 digit mantissa by default. For extra resolution, this can be increased to 6 digits by setting the resolution to 'high' in the REMOTE menu.

The SFRA45 maintains an error status byte consistent with the requirements of the IEEE488.2 protocol (called the

SFRA45 User Manual

standard event status register) that can be read by the mandatory command *ESR? (see section 5.1).

SFRA45 also maintains a status byte consistent with the requirements of the IEEE488.2 protocol, that can be read either with the IEEE488 serial poll function or by the mandatory command *STB? over RS232 or USB or LAN (see section 5.2).

Setting the LAN IP address to 0.0.0.0 will enable the DHCP and the unit will obtain its IP-Address from the DHCP server. DHCP server must be present on the network for this to work. The LAN will not start normal operation until it receives an IP address from the server.

Setting the LAN IP manually will disable the DHCP and the unit will use a fixed IP address, defined by the IP Address setting in the REMOTE menu.

RS232 data format is: start bit, 8 data bits (no parity), 1 stop bit. Flow control is RTS/CTS (see section 5.2), baud rate is selectable via the REMOTE menu.

A summary of the available commands is given in the Appendix. Details of each command are given in the communications manual.

Commands are executed in sequence except for two special characters that are immediately obeyed:

- Control T (20) – reset interface (device clear)
- Control U (21) – warm restart

6.5 Standard event status register

PON		CME	EXE	DDE	QYE		OPC
-----	--	-----	-----	-----	-----	--	-----

- bit 0 OPC (operation complete)
cleared by most commands
set when data available
- bit 2 QYE (unterminated query error)
set if no message ready when data read
- bit 3 DDE (device dependent error)
set when the instrument has an error
- bit 4 EXE (execution error)
set when the command cannot be executed
- bit 5 CME (command interpretation error)
set when a command has not been recognised
- bit 7 PON (power on event)
set when power first applied or unit has reset

The bits in the standard event status register except for OPC are set by the relevant event and cleared by specific command (*ESR?, *CLS, *RST). OPC is also cleared by most commands that change any part of the configuration of the instrument (such as MODE or START).

SFRA45 User Manual

6.6 Serial Poll status byte

		ESB	MAV	ALA	FDV		RDV
--	--	-----	-----	-----	-----	--	-----

- bit 0 RDV (result data available)
set when results are available to be read as enabled by DAVER
- bit 2 FDV (fast data available (streaming))
set when data streaming results are available to be read as enabled by DAVER
- bit 3 ALA (alarm active)
set when an alarm becomes active as enabled by ALARMER
- bit 4 MAV (message available)
set when a message reply is waiting to be read
- bit 5 ESB (standard event summary bit)
set if any bit in the standard event status register is set as well as the corresponding bit in the standard event status enable register (set by *ESE).

SFRA45 User Manual

6.7 RS232 connections

The RS232 port on SFRA45 uses the same pinout as a standard 9 pin serial port on a PC or laptop (9-pin male 'D' type).

Pin	Function	Direction
1	DCD	in (+ weak pull up)
2	RX data	in
3	TX data	out
4	DTR	out
5	GND	
6	DSR	not used
7	RTS	out
8	CTS	in
9	RI	not used

The SFRA45 will only transmit when CTS (pin 8) is asserted, and can only receive if DCD (pin 1) is asserted. KinetiQ constantly asserts (+12V) DTR (pin 4) so this pin can be connected to any unwanted modem control inputs to force operation without handshaking. KinetiQ has a weak pull up on pin 1 as many null modem cables leave it open circuit. In electrically noisy environments, this pin should be driven or connected to pin 4.

To connect the SFRA45 to a PC, use a 9 pin female to 9 pin female null modem cable:

1 & 6	-	4
2	-	3
3	-	2
4	-	1 & 6
5	-	5
7	-	8
8	-	7

6.8 RS232 printer

The RS232 port can also be connected to a serial printer for making a hard copy of any screen. When printing is enabled in the REMOTE menu then pressing START will commence a screen dump to the printer. The graphic protocol used is the ESC/P so any printer which supports this protocol should work such as the Seiko DPU-414.

The other communication options, USB, LAN or GPIB, can still be used while the RS232 printer is enabled.

7 System options

Press SYS to access the system options.

Measurements of phase can be expressed in one of three conventional formats:

- 180° to +180° (commonly used in circuit analysis)

- 0° to -360° (commonly used in power applications)

- 0° to +360°

The measurement is exactly the same it is only the way that it is expressed that changes.

The oscilloscope display may be made up of single points or lines.

Each key press is normally accompanied by an audible 'beep' as well as the tactile 'click'. The 'beep' can be disabled for quiet environments if the feel of the key is sufficient feedback

Regular autozero measurements can be suppressed.

The main function keys can be used to load stored configurations as a "one-touch" way of configuring the instrument for specific applications. This is particularly useful in a production environment where an operator has a small number of specific tests to perform.

To save these system settings as default, store the setup in program 1 so that they are reloaded on power on.

Pressing RIGHT from the SYSTEM OPTIONS menu selects the USER DATA screen where up to three lines of user-specified text may be entered. The first line is displayed on power up; all three lines may be read remotely by the command USER? to identify the instrument.

SFRA45 User Manual

Pressing LEFT from first SYSTEM OPTIONS menu displays the serial number, manufacture code, release versions, and calibration date. These cannot be changed by the user.

7.1 User data

The SFRA45 can be personalised by entering up to 3 lines of user data as text (see section on text entry).

User data is displayed every time that the instrument is switched on to identify the instrument. The entered text may also be read over the communications to identify the instrument (see USER?).

Typical arrangement of the user data might be:

- line 1 company name
- line 2 department or individual name
- line 3 unique identifying number (eg. asset number)

Any user data may be entered as required, as the lines are treated purely as text and are not interpreted by KinetiQ at all.

After changing the user data, execute 'store' to save the data in non-volatile memory.

8 Setup / Key Functions

8.1 Acquisition Mode (ACQU)

In normal acquisition mode the window over which the measurements are computed is adjusted to give an integral number of cycles of the input waveform. The results from each window are passed through a digital filter equivalent to a first-order RC low pass filter.

Speed – Has six pre-set speed options – “*very slow, slow, medium, fast, very fast and window*”– it adjusts the nominal size of the window, and therefore the update rate and the time constant of the filter. Greater stability is obtained at the slower speed at the expense of a slower update rate. Note that at low frequencies, the window is extended to cover a complete cycle of the input waveform even if this is a longer period than the nominal update rate.

Filter - Filter has three options: “*normal*”, “*slow*” and “*none*”. This sets how many samples the instrument takes before updating the display and effectively smoothes the readings. If none is selected then the readings are unfiltered and more prone to noise.

The nominal values are:

speed	update rate	normal time constant	slow time constant
fast	1/20s	0.2s	0.8s
medium	1/3s	1.5s	6s
slow	2.5s	12s	48s
very slow	10s	48s	192s

Minimum Cycles – There is also an option to set a specific size of the window to a value other than the preset options. In order to synchronise to an integral number of cycles, the window size is either reduced by up to 25% or increased as necessary.

Graph - Graph has three options: "*dual, gain* and *phase*". This sets how the frequency response is displayed, the two options work in conjunction with the computation option. Selecting '*gain*' plots the gain or loss of the signal levels between the two channels. '*Phase*' plots the phase angle difference between the two channels.

Bandwidth - Bandwidth has two options: "*auto* and *wide*". The bandwidth of the instrument, usually set to "*auto*", can be forced to "*wide*". When not in auto selection, heterodyning is disabled and the bandwidth is wide.

8.2 Sweep Mode / Key (SWEEP)

All ac measurements using the SFRA45 generator can be swept across a frequency range. The start frequency, stop frequency and number of steps up to 2000 can be specified. The measurements are subjected to the same speed constraints set in the ACQU menu, but the filtering does not apply on each measurement point. If continuous sweep is selected, then the filtering is applied to each successive sweep.

Display – Has three options: “*real time*”, “*table*” and “*graph*”. Sweeping a band of frequencies stores each step into a table. After the sweep is completed this information may then be displayed as either a table or a graph depending on the option selected. Selecting “*real time*” returns the display back to normal operation.

This information may be saved via the ‘PROG’ key either internally, on a memory stick, or directly to a PC.

Sweep Start, Sweep End and Sweep Steps – The “*sweep start*” and “*sweep end*” sets the two frequencies over which the band will cover.

The “***sweep steps***” sets the number of steps taken to cover the frequency band, at each step a reading is taken and is set depending on the accuracy and resolution required. This can be a maximum of 2000, however, the more steps entered the more memory is required.

Sweep Type – Is displayed twice on the function menu as there are two different options for each function. These options are ‘*linear/ logarithmic*’ and ‘*single/continuous*’, these are set depending on the type of sweep required.

The ‘*continuous*’ option repeats the sweep until the ‘HOME/ESC’ key is pressed which stops the sweep.

Peak Hold – Has two options “on” and “off”. However, it is only operational when the “continuous sweep” option is selected. As the sweeps continue this allows the present sweep readings to be compared against the previous readings which then determines the highest level reached.

(Phase / Gain) Graph Scaling – Has two options, “auto” and “manual”, in most cases auto-scaling will work and adjusts the graph scale automatically to suit the measurement levels.

When a more specific graph scale is needed then the “**manual**” option may be selected. This adds two functions to the left menu, “*graph maximum*” and “*graph minimum*”, here both levels can be specifically set

Frequency Marker–Has three options “off”, “single” and “dual”. If “single” is selected this adds “marker 1” function to the left menu and If “dual” is selected this also adds “marker 2” function to the left menu, allowing the setting of a specific frequency to be entered. While in the sweep mode it draws a vertical line on the graph at that frequency allowing the user to determine the measurement at that desired frequency.

Search for Peak–Has two options “on” and “off”. However, in LCR mode it has three options, “Off”, “Single”, and “Dual”. If “on” is selected, this draws a vertical line at the frequency of peak measurement, or the option of one or two frequency peaks in LCR mode.

At the end of a sweep, the generator may be set to be on or off. The settings used are those in the normal generator menu.

SFRA45 User Manual

The graph is normal scaled to +100dB and -22dB, this can be manually set to other values or set to auto-scale.

A vertical marker can be placed on the graph to reference a specific frequency.

Up to 30 sweeps may be stored in non-volatile memory using the PROG key. Sweeps are stored in blocks of 50 points, larger sweeps use contiguous blocks eg:

steps in sweep	blocks per sweep	max number of sweeps
2-50	1	30
51-100	2	15
101-150	3	10
151-200	4	7
201-250	5	6
251-500	8	3
501-1000	15	2
1001-2000	30	1

8.3 Trim mode (TRIM)

The trim function is a powerful and versatile feature that allows closed loop control of the generator amplitude. It allows a specific measurement to be programmed for either CH1 and CH2 and the generator output will be adjusted to maintain the measured voltage or current. This allows the excitation level to be controlled over changing conditions such as a frequency sweep.

AC Trim Data – Has three options: “*disabled, Ch1 and Ch2*”

AC Level, Tolerance - At each measurement point, the measured level is checked against the specified level and tolerance; if an adjustment is needed the data is discarded and a new measurement made at the new output level. The user is alerted to the adjustment by an audible beep.

Particularly important in control loop analysis, where it is sometimes referred to as amplitude compression, it prevents the control loop being overdriven as the frequency changes.

It is also useful in a more general case where test levels are specified.

Note When dBm mode level control is selected, the trim level is entered as dBm but the tolerance remains a linear percentage of the actual voltage not the logarithmic dBm measure.

8.4 Comms Key (COMMS)

Resolution – Has two options: “normal” and “high” this alters the number of digits being displayed.

Interface - Has three options: “RS232”, “USB” and “LAN” depending on the interface the user requires to connect the instrument with.

Baud Rate – Only appears when RS232 interface is selected and has four settings: 38400, 19200, 9600 and 1200 depending on the data rate of the system the instrument is interfacing with.

USB Option – The USB option activates the Type B connector at the bottom of the meter.

LAN Option – This option activates the LAN connector at the bottom of the meter and adds an “IP” address function to the menu. The address can be entered using the arrow keys.

8.5 DUT Key

Select the application-specific options from the MODE menu

Mode – Has two options: “none” and “power transformer mode”

Power Transformers:

In this mode, the measurement results will be stored in XML format which fully complies with **IEC60076-18**. This standard is applicable to power transformers, reactors, phase shifting transformers and similar equipment.

Transformer Setup

Identifier – sequence of letters and/or numbers to identify the unit under test (typically customer serial number or location identifier of the transformer or reactor)

Manufacturer – DUT manufacturer, i.e., the manufacturer of the transformer or reactor by the manufacturer

Serial Number – DUT Serial Number

Measurement Setup

Reference Terminal – identification of the DUT terminal to which the reference and source leads were connected

Response Terminal – Identification of the DUT terminal to which the response lead is connected

Connected Terminals – Identification of all terminals which were connected together during the measurement, for.eg a1-b1-c1, a2-b2-c2 would indicate that a1, b1 and c1 are connected together and a2, b2, c2 were separately connected together.

OLTC – the tap position indicated on the DUT during measurement

Temperature - the temperature of the DUT during measurement (specified in degrees Celsius)

Unshielded Length – Length of the unshielded connection for each lead

Fluid Filled – Has two options – “yes” or “no”. Yes or No depending on whether the test object was fully filled with normal operating fluid during measurement.

8.6 AUX KEY

This is for the Auxiliary Port Settings and is for future applications, it is not functional at this time

8.7 OUTPUT KEY

The Output key controls the *Signal Generator*. The signal generator is a Direct Digital Synthesis (DDS) single or sweep frequency generator. It generates Sine, Square and Triangular waveforms over a frequency range from 5Hz to 45MHz, together with a noise option. The low-level output is 10Vpk into high impedance load, (5Hz to 45MHz). It may be used independently of the other instruments that are connected to the instrument or in conjunction with them. The output negative is connected to the case. The maximum output available from the generator is a function of frequency:

Frequency MHz	output level into 50Ω	
	peak V	rms V
5	5	3.5
10	3	2
15	2	1.4
20	1.5	1
25	1.2	0.8
30	1	0.7
45	0.75	0.5

Amplitude Control – Has two options: "*V or dBm*" and controls how 'amplitude' and 'amplitude step' is displayed on the screen. Amplitude is displayed either in Volts or dBm and is adjusted using the "*output amplitude*" or "*amplitude step*" menu function. Amplitude step is set in either volts or db times the step value. The amplitude step can be set as small as one millivolt or 0.001 dBm. (Once the step has been set, using the up/down arrow keys with the main display will increase/decrease the amplitude by the step factor).

Waveform – Has five options: “*sinewave, squarewave, triangle, ramp* and *white noise*”. The use and selection of the different waveforms are dependent on user need.

Generator Frequency - This function determines the generator output frequency. The “**Frequency Step**” function determines the multiple amounts the frequency changes when required to step up or step down. The “**Step type**” can be either set for linear or logarithmic depending on user preference.

Output – This controls the relevant output connection and has two options: “*off, on*”.

8.8 Input Channels

Input – Has two options from the right menu, “*high Z*”, and “*50 Ohms*”. The two channels are controlled independently but sampled synchronously.

N4L Clamps – Has two options, “*No*”, “*Yes*”. “*No*” will disable clamp correction, “*Yes*” will enable clamp correction.

CHx input ranging – Has three options ‘*full auto range*’, ‘*range up only*’ and “*manual*”. Use full auto range for normal signals allowing the instrument to select the optimum range for the signal level. Range up is useful for rapidly fluctuating signals as the shunt will stay on the range suitable for the highest signal level. Manual will add “CHx input range” to the menu where the user can define which range is used. This is also applicable to Channel 2 when used in FRA mode. The input ranges have nominal full-scale values set with a ratio of $1:\sqrt{10}$ from 1mV to 10V. When the instrument is using selective high-frequency measurements (heterodyning) the ranges

SFRA45 User Manual

extend by approximately 50%. This gives the following ranges:

range	reference	nominal full scale	
		wideband	selective
1	3mV	3.16mV	5mV
2	10mV	10mV	15mV
3	30mV	31.6mV	50mV
4	100mV	100mV	150mV
5	300mV	316mV	500mV
6	1V	1V	1.5V
7	3V	3.16V	5V
8	10V	10V	10V

The maximum input signal that can be accurately measured varies with frequency:

frequency MHz	max input level	
	peak V	rms V
1	10	7
5	6	4
10	3	2
15	2	1.4
20	1.5	1
25	1.2	0.8
30	1	0.7
45	0.75	0.5

The input ranges may be selected manually, or by auto ranging (default). The start range for auto ranging may be selected if it is known that the signal will not be below a certain level.

There is also an option to auto range 'up only' so that a test may be carried out to find the highest range. Once the highest range has been determined, the range can be set to manual and the measurement made without losing any data due to range changing. Pressing the HOME key (or sending *TRG) restarts the auto ranging from the selected minimum range.

When in an input channel menu, the ZERO key provides a quick way to lock and unlock the range. When no flashing box is visible in the input channel menu and auto ranging is selected, pressing the ZERO key selects the range that the instrument is currently using and sets the auto ranging to manual, thus locking the range and preventing further auto ranging. Pressing the ZERO key again returns to full auto ranging from the bottom range.

For most measurement functions full auto ranging is the most suitable option but some applications, such as where transient events are occurring, are more reliable with manual ranging. Manual ranging (or up-only auto ranging) is essential for low-frequency measurements.

Scale Factor - This option is used to compensate for an attenuator or a scope probe. If using a X10 probe, putting '10' in as the scale factor gives the correct value for voltage. A nominal value can be entered or the attenuation factor of the probe can be measured and the precise value entered. The measured voltage will be displayed after multiplication by the scale factor.

8.9 System Key Functions

Language – These menu options depend on the (Country) firmware loaded, ie Italy will provide a choice of Italian or English etc.

Initial settings – This setting has three options which set the instrument initial settings at switch on. These are either the settings stored in memory program 1, as per the factory default or the settings which were last used.

Set Clock – This option sets the time. Use the UP/DOWN arrow keys to highlight hours, minutes or seconds, and the LEFT/RIGHT arrow keys to change the time.

Set Date – This option sets the date. Use the UP/DOWN arrow keys to highlight the month, day or year, and the LEFT/RIGHT arrow keys to change the date.

Display – Has three options: "*colour*", "*white on black*" and "*black on white*". The white on black option is easier to see in natural daylight due to the shielding in the glass of the display. Glare does occur in direct sunlight.

Brightness – The instrument display has two options, "*low*" and "*high*". The default setting is 'low' to conserve battery power. This option works best in the 'colour' or 'white on black' mode and makes the display easier to see in natural daylight.

Enlarge Results – Has two options "*on*" or "*off*" and changes the size of the text/numbers on the display. Each instrument mode is different.

Phase Convention – This is available in both "LCR" and "FRA" mode and displays the phase angle between the

input current and voltage. This phase angle has three options: “ -180° to $+180^{\circ}$ ”, “ 0° to -360° ” or “ 0° to $+360^{\circ}$ ” depending on user preference.

Keyboard Beep – An audible ‘beep’ is available and sounds every time a key is pressed. This option can be “*enabled*”, or “*disabled*” if the sound is not required.

Step Message – Has two options “*enabled*” or “*disabled*”. A single line message appears on the display in real time mode when stepping the frequency or amplitude up or down using the arrow keys. It shows the new value selected. The ‘step message’ may be disabled if desired.

User Settings – This function is accessed by pressing the system key followed by the ‘right arrow’ key, this will then display the screen in figure 14.1. This allows the “user” to enter three separate lines of information which are saved in a data file when “save” is selected and ENTER pressed.

User Data, Example.

(Default 1st “Newtons4th Ltd”, can be overwritten).

Figure 14.2 is an example, which in this case shows the station name, line number and technician name. The third ‘user data’ line (ie technician name), is the data displayed on the ‘PROGRAM STORE/RECALL’ display screen

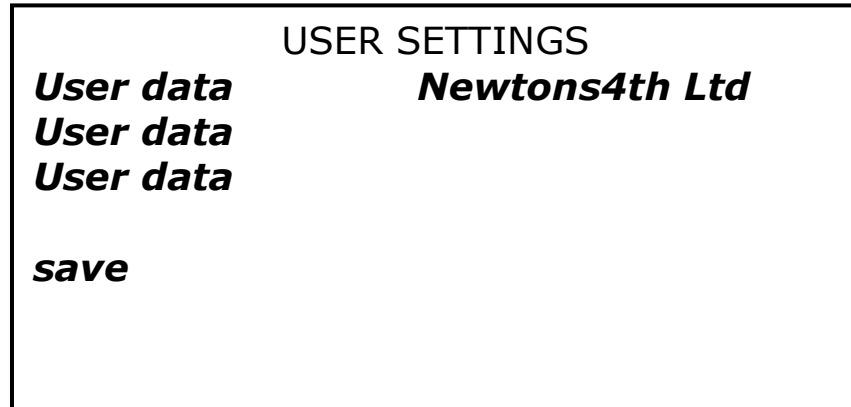

Figure 14.1 (Main Settings)

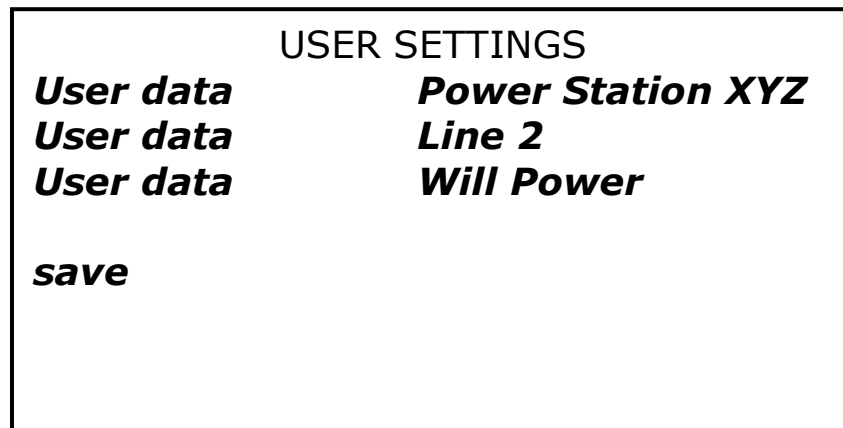

Figure 14.2 (example data)

Data Screen – The instrument Data screen is accessed by pressing the "System Key" followed by the 'left' arrow key. This displays the following system information: "serial number", "impedance", "manufacturing code", "main release", "DSP release", "FPGA release", "boot release" and "last calibration".

From this data, the user can see the instrument traceability information, firmware release levels, calibration date etc and determine if any updates are necessary or if the instrument is due calibration.

8.10 Prog Key Functions

Allows the user to internally or externally store and recall instrument setups and readings. It has the following functions: "memory", "file type", "action", "location", "name" and "execute".

The memory information in red at the bottom of the screen displays, "memory status", "available files" and "free space". This applies to the internal or external memory whichever is selected. They inform the user of the memory status, how many files are available in memory and how much memory space is still available.

All file directory information can be displayed by pressing the "Prog" key and then the "START" button. This will allow all the information to be displayed as a table and show what the internal file directory contains. (By pressing the "START" button again exits the directory).

Note: This information is also available to be read over the instrument communication link.

Memory – Memory has two options: '*internal*' and '*USB memory stick*'. The instrument has one gigabyte of internal memory. Note: "USB Memory stick" appears in blue if no device has been detected.

File type – Data has two options: '*program*' and '*results*'. Program allows the user to store a program setup that may be used to provide a specific set of tests. Results allow the user to store the results with their configuration from a specific reading or sweep.

Action – Action has three options: “recall”, “store” and “delete”. While previously selecting “program” or “results” from the “data” function, the user must decide whether to recall, store or delete the data. When storing, up to 999 setups/readings can be saved and each must have a unique number. Memory location ‘0’ is the ‘factory default’ setting. The ‘delete’ option allows the user to delete any setup or reading.

Location & Name – These functions are used together. Location must have a number but name is optional and can remain as “empty”. Using the LEFT/RIGHT arrow keys allows the location to be incremented or decremented. (0 = factory default).

Execute – Execute is used to control the ‘action’ option. After selecting an action (store, recall or delete), the ‘execute’ option is selected and the ‘enter’ key pressed.

If the memory location selected already has results or a setup stored, then the option: ‘select here and press ENTER to overwrite’, appears warning the user the location “number” already has data stored in it.

8.11 Storing Results

Press the “Prog” key

- Displays the “Program Store/Recall” screen.

Memory:

- Select “internal”.

File type:

- Select “results”.

Location:

- Using the Left/Right arrow keys increase or decrease the number until an "empty" location is found.

Name:

- Using the alpha numeric keys

Action:

- Select "Store" then Enter. This adds "user data" to the function menu, using the alpha numeric keys (This will appear as the 3rd line of user data on the systems user settings screen).

Execute:

- Select "execute" then Enter, data is now stored

8.12 Recalling Results

Press the "Prog" key

- Displays the "Program Store/Recall" screen.

Memory:

- Select "internal".

File type:

- Select "results".

Location:

- Using the Left/Right arrow keys increase or decrease until the number required is found.

Name:

- The correct name should be displayed.

Action:

- Select "recall" then Enter.

Execute:

- Select "execute" then Enter, which should now display the results. In sweep mode selecting either "graph" or "table" will have the results displayed in the desired manner.

8.13 Deleting Results

Press the "Prog" key

- Displays the "Program Store/Recall" screen.

Memory:

- Select "internal".

File type:

- Select "results".

Location:

- Using the Left/Right arrow keys increase or decrease until the number required is found.

Name:

- The correct name should be displayed.

Action:

- Select "delete" then Enter.

Execute:

- Select "execute" then Enter, this should now display the name "empty" for that location number.

8.14 Memory Status

(Displayed In Red) – “Memory status” monitors one of two items. It lets the user know how much memory is available either internally or on the USB memory stick.

The ‘available files’ function lets the user know how many data files are stored either internally or on the USB memory stick.

Storing data to the memory stick creates two files. One file extension is ‘.pcs’ and is used by the software interface provided by Newtons4th Ltd. The other file is a comma delimited text file with the ‘.txt’ extension. Full information is provided in the appendix on this file format.

(Note that 2GB is the maximum allowable size of USB memory stick that can be used)

9 Frequency Response Analyzer

The instrument measures the gain and phase of channel 2 relative to channel 1 using a discrete Fourier transform (DFT) algorithm at the fundamental frequency.

The DFT technique can measure phase as well as magnitude and is inherently good at rejecting noise – it is much more reliable than measuring the rms at one point relative to another point.

The circuit can be characterised by computing the gain and phase at a number of points over a frequency range. This gives results that show the transfer function of the circuit as a graph on the display.

The DFT analysis yields two components – in-phase and quadrature, or 'a' and 'b' values – from which the magnitude and phase can be derived.

Considering the components at the fundamental frequency:

The fundamental in-phase and quadrature values of a periodic waveform, $v(\phi)$, are given by:

$$a_1 = \frac{1}{\pi} \int_0^{2\pi} v(\phi) \cdot \cos(\phi) \, d\phi$$

$$b_1 = \frac{1}{\pi} \int_0^{2\pi} v(\phi) \cdot \sin(\phi) \, d\phi$$

SFRA45 User Manual

For a sampled signal, the formulae become:

$$a1 = \frac{1}{n} \sum_{i=0}^{i=n-1} v[i].\cos(2\pi ci/n)$$

$$b1 = \frac{1}{n} \sum_{i=0}^{i=n-1} v[i].\sin(2\pi ci/n)$$

where n is the number of samples for an integral number of complete cycles of the input waveform, and c is the number of cycles.

Having computed the real and quadrature components, the magnitude and phase of each channel can be derived:

$$\text{mag} = \sqrt{a1^2 + b1^2}$$

$$\theta = \tan^{-1}(b1/a1)$$

The relative gain and phase of the circuitry under test at that particular frequency is derived from the real and quadrature components by vector division:

$$\text{vector gain} = (a + jb) \{ch2\} / (a + jb) \{ch1\}$$

$$\text{gain} = \text{magnitude}(\text{vector gain})$$

$$\text{phase} = \tan^{-1}(b/a(\text{vector gain}))$$

The gain is usually quoted in dB:

$$\text{dB} = 20 \log_{10}(\text{gain})$$

To look at differences in gain from a nominal value, an offset gain can be applied either manually or by pressing ZERO.

$$\text{offset gain} = \text{measured dB} - \text{offset dB}$$

The filtering is applied to the real and quadrature components individually, rather than the derived magnitude and phase values. This gives superior results as any noise contribution to the components would have random phase and therefore would be reduced by filtering.

The instrument can operate either in real time mode at a single frequency where the gain and phase are filtered and updated on the display, or it can sweep a range of frequencies and present the results as a table or graphs of gain and phase.

The frequency points to be measured are specified with three parameters:

- number of steps
- start frequency
- end frequency

The Instrument computes a multiplying factor that it applies to the start frequency for the specified number of steps. Note that due to compound multiplication it is unlikely that the end frequency will be exactly that programmed. The frequency sweep is initiated by the START key, and when completed the data can be viewed as a table or graphs.

Following a sweep on a control loop, the gain and phase margins can be computed and displayed on the graph.

The window over which the measurements are computed is adjusted to give an integral number of cycles of the input waveform. In real time mode the results from each window are passed through a digital filter equivalent to a first-order RC low pass filter; in sweep mode, each result

SFRA45 User Manual

comprises a single window without any filtering unless repeat sweep is selected.

The top of the vertical axis for the graph is normally set to be the highest measured value during the sweep. The bottom of the vertical axis is normally either set to the lowest measured value or the result of the highest value less 20dB/decade of frequency. The vertical axis can be fixed to a manual scale using the menus.

The ZOOM function can be used to select up to four parameters from the display when in real time mode. It has no function following a sweep.

Following a sweep the GRAPH key selects between:
graph of gain v frequency
graph of phase v frequency
graph of gain and phase v frequency.

Pressing HOME or TRIG restarts the real-time measurement at the selected frequency.

9.1 (FRA) Screen Display Areas

The main area shows "frequency", "gain", "phase" and "delay" measurements as follows:

"Frequency": This is the frequency the generator has been set to.

"Gain": Shows the measured amplification/attenuation between the input and output.

"Phase": This is the relationship seen between the input and output phases.

"Delay": This determines the time between the input and output phases and considers this measurement to be the delay time.

"Level": The "bottom left" level displays the input rms voltage being fed into the system under test.

Note: The output level of the generator when connected to one of the inputs may differ to the measurement reading on the FRA display. This is apparent when the load isn't equal to the generator impedance setting.

"Level": The "bottom right" level displays the output rms voltage from the system under test.

SFRA45 User Manual

The other areas are:

'GENERATOR' area: Displays the generator frequency, the output level and if the output is set to 'on'.

'INPUT' area: Displays the input channel selected. When the INPUT displays anything but 'high' it is in the 'terminate' mode. The inputs available are, high and 50Ω

'MEASURE' area: Displays the measurement impedance reference and the speed of the measurement update.

10 Impedance Mode

The meter is used to measure the impedance of different circuits and can range from 100mΩ to 100kΩ. Typically used in power line carrier applications, this could be a line trap or parallel L/C in a line tuner etc.

The signal generator must be turned on to read impedance. Note: when LCR mode is selected it automatically turns the signal generator on.

For impedance measurements, normally the low output of the signal generator is fed into the 'high Z' input and the circuit under test. Through the internal shunt, the instrument measures the current drawn from the signal generator while the input measures the voltage across the circuit being tested. When sweeping across a band the instrument can detect up to two impedance peaks and markers can be set for both.

From the fundamental components of voltage, $(a + jb)$, and those of the current, $(c + jd)$, the complex impedance is given by:

$$\begin{aligned} \mathbf{z} &= \mathbf{v} / \mathbf{i} \\ &= (a + jb) / (c + jd) \end{aligned}$$

10.1 (LCR) Screen Display Areas

The main area shows "frequency", "impedance", "phase" and "level" measurements as follows:

"Frequency": is the frequency the generator is currently running at.

"Impedance" is the value (Ω) measured as a ratio of the voltage and phase angles.

"Phase" is the phase angle in degrees between the voltage and current phases.

"Level" is the rms voltage and current levels measured.

The other areas are:

'GENERATOR' area: Displays the generator frequency, the output level and if the output is set to 'on'

'INPUT' area: Displays the input channel selected. When the INPUT displays anything but 'high' it is in the 'terminate' mode. The inputs available are, high Z, 50 Ω 18 W, low level and balanced.

'MEASURE' area: Displays the measurement impedance reference and the speed of the measurement update.

11 AC RMS Mode

The RMS voltmeter measures the AC rms of the signal present at the input terminals to the bandwidth of the instrument (>1MHz). Care must be taken when measuring low signal levels to minimise noise pick on the input leads.

The RMS voltmeter measures the elementary values:

- rms
- peak
- surge

and derives the values: ac, dBm and crest factor.

The rms value of a periodic waveform, $v(\phi)$, is given by:

$$\text{rms} = \sqrt{\left[\frac{1}{2\pi} \int_0^{2\pi} v^2(\phi) d\phi \right]}$$

For a sampled signal, the formula becomes:

$$\text{rms} = \sqrt{\left[\frac{1}{n} \sum_{i=0}^{i=n-1} v^2[i] \right]}$$

where n is the number of samples for an integral number of complete cycles of the input waveform.

These are fundamental definitions that are valid for all waveshapes. For a pure sinewave, the formulae equate to $\text{peak}/\sqrt{2}$, but this cannot be applied to other waveshapes. The SFRA45 computes the true rms value from the fundamental definition for sampled data.

SFRA45 User Manual

$$dc = \frac{1}{2\pi} \int_0 v(\phi) d\phi$$

Having computed the true rms and the dc component, the ac component can be derived from:

$$rms^2 = ac^2 + dc^2 \quad \Rightarrow \quad ac^2 = rms^2 - dc^2$$

The ac component is also expressed in dB referred to 1mW into 600Ω (dBm):

$$dBm = 20 \log (V_{ac}/V_{ref})$$

where $V_{ref} = \sqrt{(1mW \times 600\Omega)}$

or $20 \log (I_{ac}/I_{ref})$

where $I_{ref} = \sqrt{(1mW / 600\Omega)}$

The peak measurement is simply the value with the largest magnitude. Positive and negative peaks are independently filtered then the result with the largest magnitude is taken as the peak value.

In order to measure surge conditions, the maximum instantaneous peak value (unfiltered) is also recorded. It is important that the device does not auto range while measuring surge – either set the range to manual or repeat the test with ranging set to up only. To reset the maximum, press START.

Crest factor is derived from the peak and rms:

$$cf = peak / rms$$

SFRA45 User Manual

The measurements are computed over rectangular windows with no gaps. The processing power of the DSP allows the measurements to be made in real time without missing any samples. In this way, the measured rms is a true value even if the signal is fluctuating. The only occasion when data is missed is when an autozero measurement is requested – this can be disabled in the SYSTEM OPTIONS menu if required.

The ZOOM function can be used to select any combination of up to four parameters from the display.

Note that the wideband nature of true rms measurements prevents the use of heterodyning so the frequency range of the measurement is limited to 5MHz. To minimise noise, there is a 50kHz filter applied by default. To obtain the full bandwidth press ACQU, highlight bandwidth and select “wide”.

12 Oscilloscope Mode.

The oscilloscope can be either single or dual trace and has a sample rate of 5Msamples/s and a time base sweep of 5 μ s/div to 5s/div, this provides the user with a convenient tool for displaying and analyzing input waveforms.

The oscilloscope has six functions available: '*timebase*', '*trigger level*', '*trigger mode*', '*trigger polarity*', '*pretrigger*' and '*traces*'.

Timebase - Sets the sweep rate of the oscilloscope, the setting can be adjusted by following the "Keypad Operation" instructions in section 4.1.

Trigger level – Sets the minimum voltage required to start a sweep and can be adjusted by following the "Keypad Operation" instructions in section 4.1.

Trigger mode – Has three options: '*auto*', '*normal*' and '*single shot*'.

'Auto' puts the oscilloscope in the *auto run* mode where the trace is synchronized to the trigger event. However, in this mode it draws a trace even if no trigger event is seen.

'Normal': Sets the trace to respond to each trigger event. If there are no trigger events the display is not updated until a trigger event occurs.

'Single shot': Sets the trace to respond only to the first trigger event captured. By pressing the "Home/Esc" key re-arms the trigger circuit for the next event capture.

Trigger Polarity - Has two options: '*rising edge*' and '*falling edge*'. Selecting '*rising edge*' sets the oscilloscope to start the sweep when the trigger voltage goes positive.

Selecting 'falling edge', sets the oscilloscope to start the sweep when the trigger voltage goes negative.

Pre-trigger – Has four options: '*none*', '*25%*', '*50%*' and '*75%*'. This determines the amount of pre-trigger or waveform display delay based on the mark/space ratio time of the waveform. '*None*' has no pre-triggering and therefore the waveform starts at the beginning of the trace. '*25%*' has a pre-trigger time of a quarter of the mark/space ratio time, so the triggering edge of the waveform is displayed after the trace starts by 25% of the mark/space ratio time. This is also applicable for 50% and 75% depending on the pre-trigger time required.

Traces – Traces has three options: '*single*', "*dual*" and "*ch2 current*". This selects either single or dual trace input voltage operation. However, in ch2, this will show the current waveform developed across the generator shunt.

SFRA45 User Manual

13 Technical Specifications

AC RMS	
Channels	2 (Ground Referenced)
Measurement	AC RMS, dbm, peak, cf, surge
Frequency	5Hz to 5MHz
Inputs (Unbalanced) Type & Connection	Ground Referenced BNC
Input Impedance	1M or 50 Ohms (selectable)
Accuracy (ac)	0.05% range + 0.05% reading + 0.1mV < 1KHz 0.15% range + 0.15% reading + 0.1mV < 10KHz 0.5% range + 0.5% reading + 0.0025%/KHz + 0.4mV < 5MHz
Frequency Setting	All frequencies to 6 digit resolution

SIGNAL GENERATOR	
Generator Type	Direct Digital Synthesis (DDS), Single Frequency or sweep
Generator Waveforms	Sinewave, Square, Triangle, Ramp, White Noise
Frequency Accuracy	±5ppm overall temperature range
Magnitude Accuracy	±5% <10MHz ±10% <45MHz

IMPEDANCE ANALYZER	
Impedance Range	100mΩ to 100KΩ
Accuracy	±0.5% +2%/MHz
Frequency Range	5Hz to 5MHz
Features	LCR Measurements (Inductance, Capacitance, Resistance, Tan delta QF). Impedance versus frequency curve.

OSCILLOSCOPE	
Sample Rate	5 Msamples/S
Timebase	5μs/div to 5s/div
Trigger	Auto, Normal, or Single shot
Pretrigger	None, 25%, 50%, 75%
Input Ranges	As Selective level Meter
Second Input (CH2)	±10v Peak 1MΩ ±5% // 30pf

SFRA45 User Manual

FREQUENCY RESPONSE ANALYSER	
Frequency Range	5Hz to 45MHz
Gain Accuracy dB	0.02dB < 50KHz 0.02dB + 0.05dB/MHz < 5MHz 0.1+0.04dB/MHz < 45MHz
Phase Accuracy°	0.05° < 10KHz 0.007°+0.0009°/KHZ<5MHz 5.05+0.0001*/KHZ<45MHz
GENERAL SPECIFICATIONS	
Sweep Steps	Up to 2000 steps in all sweep functions
Set-up and Data Storage	Up to 1000 analyzer setups, readings and sweep results can be stored.
Interface	USB, RS232, LAN
Real Time Clock	Time and date stamp for data stores
Data Storage	Internal 1Gb flash, external USB pen port *
Display and Resolution	¼ VGA Colour, 6 digit frequency, 5 digit voltage, 4 digit dBm
Power Source	9 – 18v @ 3A AC adapter or 12v dc from vehicle or external batteries
Battery Type and capacity	3 x Lithium polymer (up to approx 2 hours)
Temperature Range	-5°C to +50°C

*(Note that 2GB is the maximum allowable size of USB memory stick that can be used)

14 Appendix A – Text File Format

Saving test results generates two files. The file name is represented by the number location chosen (1-999) from the 'PROGRAM STORE/RECALL' menu. For example, if the file location chosen is: 11, the files generated would be PCA_R011.pcs and PCA_R011.txt. Each file has the same name but different extensions. The first file with the .pcs extension name is the file that the instrument uses to display the test results when that file is recalled.

The second file is a comma delimited text file (CSV) and may be viewed using any text editing/viewing program. The text file has two parts, the header section and the data/results section. The header includes the status of the instrument at the time the test results were taken. This information includes all three USER data inputs from the 'USER SETTINGS' menu, the file name, time and date stamp, serial number, last calibration date and other pertinent information.

The data may be imported into Excel or other programs that can access comma delimited files. Section 21.1 is the header information from a sample impedance sweep file. The information in the header is explained in the '**Header Format**' following the example file.

Note: The header information varies based on the setup of the instrument.

14.1 Example Text File

```
NEWTONS4TH LTD
Instrument,type,SFRA45
,serial number,1216
,firmware version,2.13
,calibration,10_DEC_2008_1029_SBC
User ID
,user name 1,PowerComm Solutions
,user name 2,
,user name 3,John Doe
Record,file name,PCA_R011.TXT
,name,Test
,datestamp (mmddyyyy),05262009
,timestamp,1132
measurement settings,mode,impedance meter
,measurement,impedance magnitude
,speed,medium
,filter,normal
generator settings,amplitude control,V
,low output amplitude, 2.0000E+00,Vrms
,amplitude step, 1.1000E+00
,fsk control,disabled
,generator frequency, 5.0000E+04,Hz
,frequency step, 1.0000E+02,Hz
,waveform,sinewave
,output,low
,output impedance,50 Ohms
input settings,input,high Z
,scale factor, 1.0000E+00
,CH1 input ranging,full autorange
sweep settings,display,graph
,sweep start, 3.0000E+04,Hz
,sweep end, 5.0000E+05,Hz
,sweep steps,32
,sweep type,linear
,sweep type,single
,graph scaling,auto
,marker,off
,search for peak,off
```

14.2 Text File Header Format Explanation

- The first line 'NEWTONS4TH LTD' is the name of the company that manufactures the instrument and is embedded in the firmware.
- Lines two to five are the serial number of the instrument, manufacturing code, firmware release versions and date of the last calibration. This information is accessed by pressing the 'SYSTEM' key and the 'LEFT ARROW' key.
- Lines six to nine are the 'user data' area. This information is accessed by pressing the 'SYSTEM' key and the 'RIGHT ARROW' key.
- Lines ten to thirteen are from the 'PROGRAM STORE/RECALL' menu. These lines provide the number (000 to 999) of the file (location), the name of the file and the date and time stamp that was provided at the time the data was saved in the instrument.
- Lines 14 to 17 are from the 'MEASUREMENT SETTINGS' menu. These lines provide the mode the instrument was in when the data was acquired, how the measurement was taken and the speed and filter settings.
- Lines 18 to 26 are the 'GENERATOR SETTINGS'. These lines provide the settings of the generator at the time the data was acquired.
- Lines 27 to 29 are the 'INPUT SETTINGS'. These lines provide the input settings at the time the data was acquired.
- Lines 30 to 38 are the 'SWEEP SETTINGS'. These lines provide the input settings at the time the data was acquired.

14.3 Text File Example Sweep Data

The data portion of the file starts at 'Results, sweep data'. This example is an impedance sweep. There are five columns of data: Frequency (Hz), Impedance (Ohms), Phase (degrees), Resistance (Ohms) and Reactance (Ohms).

The two columns Frequency and Impedance may be used in Excel to plot a frequency versus impedance graph. All information is given in scientific notation.

In this example, the frequency starts at 150 kHz and goes to 210 kHz. The impedance starts at 252 ohms and goes to a peak impedance of 6700 ohms and then down to 235 ohms. Note: the headers and columns do not line up.

Results,sweep data

Frequency(Hz),Impedance(Ohm),Phase(deg),Resistance(Ohm),Reactance(Ohm)

```

1.5000E+05, 2.5299E+02, 8.9272E+01, 1.9924E+04, 2.5301E+02
1.5122E+05, 2.6595E+02, 8.9195E+01, 1.8921E+04, 2.6597E+02
1.5245E+05, 2.8018E+02, 8.9104E+01, 1.7916E+04, 2.8021E+02
1.5367E+05, 2.9589E+02, 8.8996E+01, 1.6897E+04, 2.9594E+02
1.5490E+05, 3.1331E+02, 8.8875E+01, 1.5960E+04, 3.1337E+02
1.5612E+05, 3.3274E+02, 8.8739E+01, 1.5113E+04, 3.3282E+02
1.5735E+05, 3.5461E+02, 8.8583E+01, 1.4334E+04, 3.5471E+02
1.5857E+05, 3.7929E+02, 8.8400E+01, 1.3579E+04, 3.7944E+02
1.5980E+05, 4.0746E+02, 8.8190E+01, 1.2898E+04, 4.0767E+02
1.6102E+05, 4.4011E+02, 8.7904E+01, 1.2031E+04, 4.4040E+02
1.6225E+05, 4.7794E+02, 8.7612E+01, 1.1468E+04, 4.7835E+02
1.6347E+05, 5.2246E+02, 8.7259E+01, 1.0924E+04, 5.2306E+02
1.6469E+05, 5.7575E+02, 8.6835E+01, 1.0430E+04, 5.7663E+02
1.6592E+05, 6.4062E+02, 8.6313E+01, 9.9621E+03, 6.4195E+02
1.6714E+05, 7.2129E+02, 8.5656E+01, 9.5223E+03, 7.2337E+02
1.6837E+05, 8.2443E+02, 8.4810E+01, 9.1143E+03, 8.2782E+02
1.6959E+05, 9.6025E+02, 8.3673E+01, 8.7134E+03, 9.6614E+02
1.7082E+05, 1.1480E+03, 8.2109E+01, 8.3617E+03, 1.1589E+03
1.7204E+05, 1.4224E+03, 7.9769E+01, 8.0082E+03, 1.4454E+03
1.7327E+05, 1.8611E+03, 7.5908E+01, 7.6439E+03, 1.9189E+03
1.7449E+05, 2.6516E+03, 6.8864E+01, 7.3535E+03, 2.8428E+03
1.7571E+05, 4.3198E+03, 5.2361E+01, 7.0735E+03, 5.4552E+03
1.7694E+05, 6.7700E+03, 6.1537E+00, 6.8092E+03, 6.3152E+04
1.7816E+05, 4.6626E+03,-4.4704E+01, 6.5601E+03,-6.6282E+03
1.7939E+05, 2.8250E+03,-6.3450E+01, 6.3203E+03,-3.1581E+03
    
```

SFRA45 User Manual

1.8061E+05, 1.9707E+03,-7.1084E+01, 6.0789E+03,-2.0832E+03
1.8184E+05, 1.5017E+03,-7.5157E+01, 5.8618E+03,-1.5535E+03
1.8306E+05, 1.2105E+03,-7.7630E+01, 5.6503E+03,-1.2393E+03
1.8429E+05, 1.0138E+03,-7.9289E+01, 5.4552E+03,-1.0318E+03
1.8551E+05, 8.7227E+02,-8.0463E+01, 5.2643E+03,-8.8450E+02
1.8674E+05, 7.6550E+02,-8.1345E+01, 5.0871E+03,-7.7432E+02
1.8796E+05, 6.8228E+02,-8.2022E+01, 4.9162E+03,-6.8895E+02
1.8918E+05, 6.1556E+02,-8.2563E+01, 4.7553E+03,-6.2078E+02
1.9041E+05, 5.6086E+02,-8.3000E+01, 4.6022E+03,-5.6507E+02
1.9163E+05, 5.1521E+02,-8.3355E+01, 4.4521E+03,-5.1870E+02
1.9286E+05, 4.7641E+02,-8.3605E+01, 4.2773E+03,-4.7939E+02
1.9408E+05, 4.4332E+02,-8.3859E+01, 4.1438E+03,-4.4587E+02
1.9531E+05, 4.1459E+02,-8.4073E+01, 4.0149E+03,-4.1682E+02
1.9653E+05, 3.8945E+02,-8.4259E+01, 3.8935E+03,-3.9142E+02
1.9776E+05, 3.6727E+02,-8.4421E+01, 3.7777E+03,-3.6902E+02
1.9898E+05, 3.4753E+02,-8.4561E+01, 3.6662E+03,-3.4910E+02
2.0020E+05, 3.2988E+02,-8.4684E+01, 3.5609E+03,-3.3131E+02
2.0143E+05, 3.1396E+02,-8.4787E+01, 3.4556E+03,-3.1526E+02
2.0265E+05, 2.9957E+02,-8.4880E+01, 3.3566E+03,-3.0077E+02
2.0388E+05, 2.8649E+02,-8.4962E+01, 3.2622E+03,-2.8760E+02
2.0510E+05, 2.7451E+02,-8.5035E+01, 3.1716E+03,-2.7555E+02
2.0633E+05, 2.6356E+02,-8.5098E+01, 3.0842E+03,-2.6452E+02
2.0755E+05, 2.5345E+02,-8.5156E+01, 3.0014E+03,-2.5436E+02
2.0878E+05, 2.4412E+02,-8.5210E+01, 2.9231E+03,-2.4497E+02
2.1000E+05, 2.3547E+02,-8.5255E+01, 2.8464E+03,-2.3628E+02

SFRA45 User Manual

Appendix A – Contact details

Please direct all queries or comments regarding the SFRA45 instrument or manual to:

Newtonson4th Ltd.
1 Bede Island Road
Leicester
LE2 7EA
United Kingdom

Tel: (0116) 230 1066 international +44 116 230 1066
Fax: (0116) 230 1061 international +44 116 230 1061

E-mail address: sales@newtonson4th.com
 office@newtonson4th.com

web site: www.newtonson4th.com

At Newtonson4th Ltd. we have a policy of continuous product improvement and are always keen to hear comments, whether favourable or unfavourable, from users of our products.

An example comment form can be found at the end of this manual – if you have any comments or observations on the product please fill a copy of this form with as much detail as possible then fax or post it to us.

Alternatively, send an e-mail with your comments.

SFRA45 comments

serial
number:

main release:
dsp release:
fpga release:
boot release:
(press SYS then LEFT)

date:

your contact details:

comments:

detailed description of application or circumstances:

Please post or fax to Newtons4th Ltd.