

**Programmable Switch Mode  
Power Supplies  
DCX 400W series**

**User Manual**

**scientific**

---

Copyright © Scientific All rights reserved.

## Disclaimer

This instrument contains proprietary information, no part of this manual may be photocopied, reproduced or translated without any prior written consent.

Information in this manual supercede all corresponding previous released material.

Scientific continues to improve products and reserves rights to amend part or all of the specifications, procedures, equipment at any time without notice. Scientific shall not be liable errors contained in this document or if for incidental or consequential damages in connection with the furnishing, performance or use of this material.

Rev 1.02/ 0222

Scientific Mes-Technik Pvt. Ltd.,  
B-14 Industrial Estate, Pologround,  
Indore- 452015,  
India  
Tel : 0731-2422330/31/32/33  
Fax : 0731-2422334,561641  
Email : [info@scientificindia.com](mailto:info@scientificindia.com)  
Website: [www.scientificindia.com](http://www.scientificindia.com)



# Programmable Switch Mode Power Supplies

## DCX Series 400 W

### Table of Contents

<b>Introduction</b>	6
<b>Safety instructions</b>	7
<b>Safety symbols</b>	9
<b>Chapter 1 Technical specifications</b>	10
1.1 Specifications	10
1.2 Power supply outline drawings - dimension	14
<b>Chapter 2 Panel controls</b>	17
2.1 Front panel controls	17
2.2 Rear panel controls	19
2.3 Sockets, connector description used on rear panel	21
2.4 Connection diagram for interface cables	23
<b>Chapter 3 Installation</b>	25
3.1 AC Input mains connections	25
3.2 Cooling	25
3.3 Use of instrument on table top	26
3.4 Use of instrument in 19" Rack mounting cabinet	26
3.5 High Voltage Protection	27
3.6 First time operation power ON	28
3.6.1 AC mains input	28
3.6.2 Connecting to AC mains	28
3.6.3 DC output check	29
3.6.4 DC constant current check	29
<b>Chapter 4 Descriptions</b>	31
4.1 Safety first - grounding	31
4.2 Input Voltage	31
4.3 Operating conditions	31

4.3.1	Temperature & humidity	31
4.3.2	Storage	32
4.4	Thermal protection	32
4.5	Cooling	32
4.6	Output	32
4.7	Connecting the load	34
4.8	Local & remote Sensing	35
4.9	Constant voltage and constant current mode	36
4.10	Hold up time	36
4.11	Over voltage protection	36
4.12	Under voltage limit	37
4.13	Fold back protection	37
4.14	AC fail	37
4.15	Analog programming	38
4.16	Description of analog connector pins and application	38
4.17	Safe start - auto start mode	42
4.18	Last save memory	42
4.19	Front panel locking	42
4.20	Remote control RS232 , RS485	42
4.21	Connecting load	42
4.22	Connecting power supplies in series and parallel	44
4.23	Power supply as battery charger	44
<b>Chapter 5</b>	<b>Menu controls</b>	<b>45</b>
5.1	Power ON switching	45
5.2	Voltage & Current setting	46
5.3	Over Voltage setting	46
5.4	Under Voltage setting	47
5.5	Fold back protection	47
5.6	Output On / OFF	47
5.7	Communication set menu	48
5.8	Front panel lock	50
<b>Chapter 6</b>	<b>Communication interface protocol</b>	<b>51</b>
6.1	SCPI Commands	51
6.2	Additional Control Commands	54

**Chapter 6 Maintenance** ..... 59

    6.1 Troubleshooting ..... 59

**Chapter 7 Dispatch procedure for service & Warranty**..... 62

    7.1 Dispatch procedure for service ..... 62

    7.2 Warranty ..... 62

## Programmable Switch Mode Power Supply DCX Series 400 W

- Compact 2 U - 1/6<sup>th</sup> 19" rack size
- Multi range Output
- Fast transient response
- High slew Rate
- Interface USB, RS232 , RS485 , LAN
- Universal Mains

The DCX Series 400 W power supplies are designed for compact 85 mm height (2U) - in 1/6<sup>th</sup> 19" Rack size with user friendly operation and higher efficiency. This range offer multi ranging output characteristic, which delivers multiple voltage and current combination in a single power supply.

Transient response better than 100 us, ensures that the output of the power supply recovers much faster and remains constant and oscillation free for dynamic loads.

Power supplies can be remotely controlled & programmed through any of interface analog programming , USB, Rs232, RS485 or Ethernet (LAN). Power supplies can be programmed from 0 to full scale voltage and current. SCPI compatible commands offer flexibility in programming and system integration.

With various protection features, over voltage protection, short circuit protection, protects expensive loads circuits in testing.

The power supply unit can work on universal mains input range for worldwide operation. It can be operated from line voltage 90 V ~ 270 V , 47 Hz ~ 63 Hz. Power factor correction also provides to ensure low harmonic content.

## Safety instructions

The general safety instructions and symbols must be observed during all phases of operation of this instrument. Failure to comply with these precautions or with specific warnings or instructions given in this manual violates safety standards of design, manufacture, and intended use of the instrument. Scientific assumes no liability for the customer's failure to comply with these requirements.

- Before applying power, verify all the safety precautions are taken, make all the connections firm.
- Make sure the protective ground of the unit is connected with system ground.
- Always operate the instrument only in prescribed operating conditions.
- Do not modify the instrument. This instrument is designed to meet all the safety and operating conditions. Any modification done may not be complying to the safety requirement and instrument may be damaged, causing hazardous conditions.

## Environmental conditions

Please do not operate the instrument in the place that vibrates, dusty, under direct sunlight or where there is corrosive air. The Scientific Power supplies are designed for safety, applies to following conditions.

- Indoor use.
- Ambient temperature 0 ~ 50°C non condensing 75% RH , 0~40°C non condensing 95% RH
- Altitude up to 3000 meters
- Pollution degree 2

## Installation category

These instruments are designed for installation category II, Over voltage category II.

## Grounding

The instrument ground must be well connected to instrument chassis of AC power mains input supply. The instrument must be connected through three conductor power cable, with the ground wire firmly connected to the electrical safety ground of power outlet. Any interruption in protective ground conductor , or disconnection will cause potential hazard that might cause personal injury.

## **Mains Input rating**

This power supply unit is designed for specific mains input connections, as specified in the Technical specifications. Do not use AC supply exceeding the limits. For safety reasons the mains AC may should not fluctuate more than  $\pm 10\%$  of nominal voltage.

## **Fuse**

Fuses must be changed by authorized Scientific service personal only for continued protection against risk and safety.

## **Live circuits**

There are no serviceable part or alignment required by Operating personnel. Operator must not remove the instrument cover. No internal adjustment or component replacement is allowed by non-Scientific authorised qualified personnel. Never replace components with power cable connected. To avoid injuries, always disconnect power, discharge circuits and remove external voltage source before touching components.



## Safety symbols

### Caution !

Caution ! : Denotes a hazard. Failure to follow instructions could result in minor personal injury and/or property damage. Follow the instructions for proper procedures.

### Warning !

Warning ! : Denotes a hazard. Failure to follow instructions could result in **SEVERE** personal injury and/or property damage. Follow the instructions for proper procedures.

### Symbols marked on instruments



Attention refer to the manual.



Hazardous voltage exists,  
**Caution !** Electric shock.



Indicates Protective Ground  
Terminal



Indicates Ground Terminal



Off ( Supply )



On ( Supply )

### Information on electrical and electronic equipment recycling

Our Equipment contain high quality components and material and are designated to facilitate recycling. After appropriate use of this equipment , when this is to be discarded , the equipment must not be treated as municipal waste. This must be disposed of separately via the appropriate return and collection system available. By following these instructions, you ensure that the product is treated correctly and help to reduce potential impacts on the environment and human health, which otherwise result from inappropriate handling. Recycling helps to conserve natural resources and protect environment.

For more information on collection and return, please contact dealer / from where you have purchased / to us giving full details.

## Chapter 1 Technical specifications

Unless otherwise stated these specifications are defined over the temperature range of 0 to 40° C .

### 1.1 Specifications

	DCX20M40	DCX60M14	DCX160M5	DCX300M2.6
DC Outputs Voltage	20 V	60 V	160 V	300 V
	Multi Ranging (Parabolic)*			
DC Output Current	40 A	14 A	5 A	2.67 A
Power	400 W	432 W	400 W	400W
Efficiency at 230V full load	82 %	85 %	86 %	87 %
Constant Voltage Mode				
Load regulation 0 ~ 100%	3mV	5mV	10 mV	15mV
Line Regulation	2 mV	3 mV	5 mV	8 mV
Ripple 5Hz~1MHz	5mV <sub>rms</sub>	5mV <sub>rms</sub>	20mV <sub>rms</sub>	30mV <sub>rms</sub>
Ripple 20 MHz	40mV <sub>rms</sub>	50mV <sub>rms</sub>	80mV <sub>rms</sub>	130mV <sub>rms</sub>
Constant Current Mode				
Load regulation 0 ~ 100 %	10 mA	7 mA	5 mA	5 mA
Line Regulation	8 mA	5 mA	3 mA	3 mA
Ripple BW= 5 Hz ~1MHz	50mA <sub>rms</sub>	20mA <sub>rms</sub>	10mA <sub>rms</sub>	8mA <sub>rms</sub>
Remote sense drop typically	1 V	2 V	2 V	2 V
Programing Speed				
Rise time ( 10% to 90% ) into resistive load				
Time 100% load	10V:6.5ms	30V:20ms	80V:50ms	150V:100ms
	20V:15ms	60V:55ms	160V:170ms	300V:240ms
Fall time ( 90% to 10% ) into resistive load				
Time 100% load	10V:6.5ms	30V:6ms	80V:30ms	150V:60ms
	20V:25ms	60V:70ms	160V:200ms	300V:300ms
Time No load	10V:150ms	30V:400s	80V:1.2s	150V:3s
	20V:250ms	60V:700ms	160V:2.5s	300V:5ms

	DCX20M40	DCX60M14	DCX160M5	DCX300M2.6
Recovery Time				
Recovery within	50 mV	75 mV	200 mV	350mV
time @ 50 step 100 % load	100 us	100 us	100 us	100 us
Temperature Coefficients	CV : 50 ppm/°C CC : 100 ppm after warm up of 30 min and during 8 hrs			
Output Stability	CV : 100 ppm/°C CC : 300 ppm after warm up of 30 min and during 8 hrs			
Analog Programming (Rear panel 15 pin D connector (Female))				
Programming	Voltage : 0 ~ 5 V, Accuracy : $\pm 1$ % of Vout rated, Input impedance : 1 M Current : 0 ~ 5 V, Accuracy : $\pm 1$ % of Iout rated, Input impedance : 1 M $\Omega$			
Monitoring	Voltage : 0~5V, Accuracy : $\pm 1$ % of Vout rated Output impedance : < 2 $\Omega$ / 0.4 mA max Current : 0~5V, Accuracy : $\pm 1$ % of Iout rated Output impedance : 2 $\Omega$ / 0.4 mA max			
V reference	5.1 V $\pm$ 10 mV			
Resistor Programming	Voltage : 0~100%, 0~5 kOhm full scale , Accuracy and linearity: $\pm 1$ % of Vout rated Current : 0~100%, 0~5 kOhm full scale , Accuracy and linearity: $\pm 1.5$ % of Iout rated			
Status Input / outputs	Power Supply : OK = Logic 1 (High),			
Remote Shut Down	with +5V or relay contacts			
Remote Programming				
RS232 / USB / RS485/ LAN	ADC : 16 Bits, DAC : 16 Bits			
Voltage Programing	Resolution : Better than 15 bit Accuracy : 0.05% Vout + 0.05% Vrated			
Current Programing	Resolution : Better than 15 bit Accuracy : 0.1% Iout + 0.1% Irated			
Monitor Voltage	Resolution : Better than 15 bit Accuracy : 0.1% Vout + 0.1% Vrated			
Monitor Current	Resolution : Better than 15 bit Accuracy : 0.25% Iout + 0.2% Irated			
OVL & UVL Programing	Resolution : Better than 15 bit Accuracy : 0.05% Vout + 0.05% Vrated			

		DCX20M40	DCX60M14	DCX160M5	DCX300M2.6
Front Panel controls	Mains ON/ OFF, Voltage and Current setting with Encoders, Switch Settings: Set, Over Voltage, Under Voltage, Foldback, Remote & Output				
Indicators (LED)	CV, CC, Over Voltage, Under Voltage, Foldback, Remote & Output ON				
Display	4 digit, voltage and current separately				
	Accuracy : $\pm (0.5 \% + 2 \text{ d})$				
Display scale	Voltage	0~20.00V	0~60.00V	0~160.0V	0~300.0V
	Current	0~40.00A	0~14.00A	0~5.00A	0~2.67A
Protections	Over voltage: Adjustable from 0.5 V ~ 105 % of Vmax, Output shut-down, reset by Output switch				
	Over current: Max current limited by CC setting, / Output Disable via Foldback				
	Over temperature: Output gets OFF, after preset internal safe temperature				
	Foldback Protection: Selectable from CV to CC mode or CC to CV mode transition with Programmable Delay for output switched OFF				
Output Terminals	Bus bar and 2 wire connections for remote sense / Optional Front Terminals				
Parallel operation	upto 6 units in Master/Slave Mode				
Serial operation	2 Units in series of same models, max 600V to chassis				
Mains Input	Universal AC input, Single phase, 90 ~ 270V, 50 / 60 Hz ( 47 ~ 63Hz) , Input connector : IEC320/C14 , EN 60320/14, Standby Power : 13 Watts @ 230V (Vout max, No load) Internal Fuse L : 6 A, 5 x 20 mm ceramic fuse.				
Power Factor	0.97 @ full load / 0.98 @ 50% load				
Turn On delay	600 ms after mains switched ON				
Inrush current	<15A				
Hold up Time	20 ms				
Environment Conditions					
Operating Temperature	0 ~ +50°C; with 100% load; derated to 75% at 60°C				

	DCX20M40	DCX60M14	DCX160M5	DCX300M2.6
Storage	-40 ~ + 85°C			
Humidity	max. 95% non condensing at 40°C, max. 75% non condensing at 50°C			
Safety	Insulation : Input to Output : 1500 Vdc for 1 min ; Input to case : 1500 Vdc , Insulation resistance : 100 MΩ at 25°C, 70% RH, 500 Vdc			
Dimension	W x D x H : 70 x 421 x 85 mm ( 2U, 1/6 19" Rack size) W x D x H : 70 x 421 x 125 mm ( For front output option) excluding connectors, terminals, switches, front and back panel controls, handles etc.			
Weight	3.2 kg			
Cooling	Forced , temperature controlled variable speed			
Accessories Supplied	Mains Cable, PC Interface Cable, Manual			

**Notes:**

1. Sensing at the rear panel of the power supply unit at sense terminals.
2. Unit warm up time is 30 min.
3. Minimum output voltage guaranteed to maximum of 0.2% rated.
4. Minimum output current guaranteed to maximum of 0.4% rated.

(Subject to change without notice.)

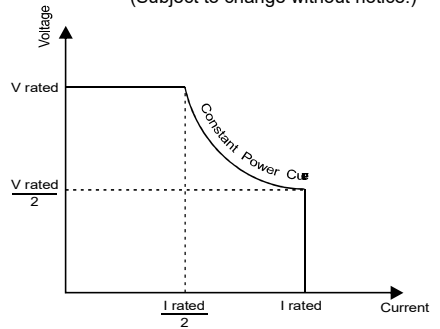

## 1.2 Power supply outline drawings - dimension

Front panel when unit is used on table top :

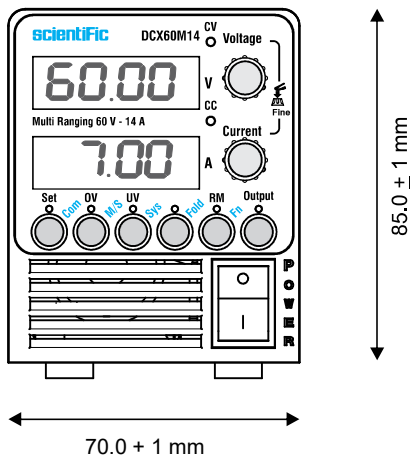

Note : Height excluding instrument feet

Front panel when unit is mounted in 19" rack cabinet :

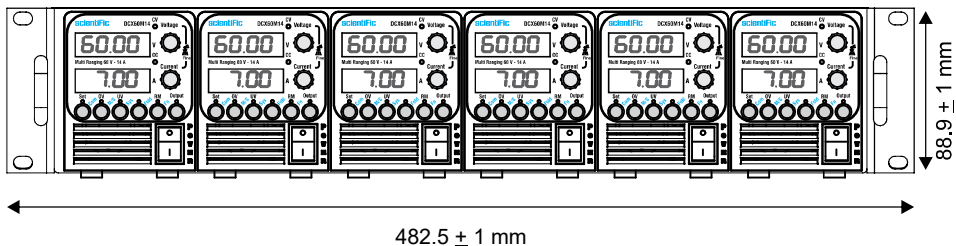

Note : When the power supply unit is mounted in 19" rack cabinet, instrument feet are removed and maximum 6 units can be assembled in 19" rack mount kit.

**Rear panel when unit is used on table top :**

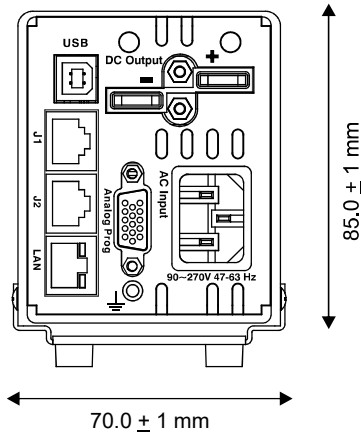

**Side view when unit is used on table top :**

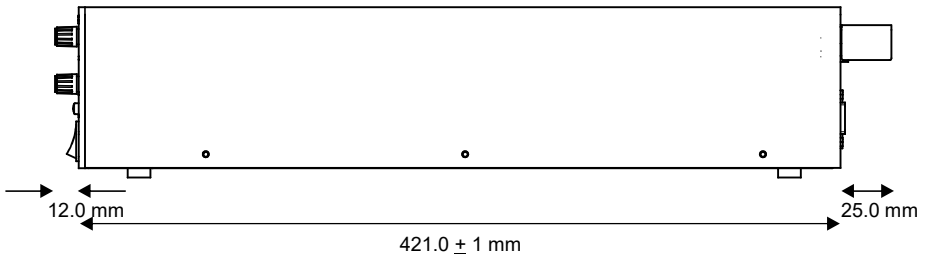

**Top view :**

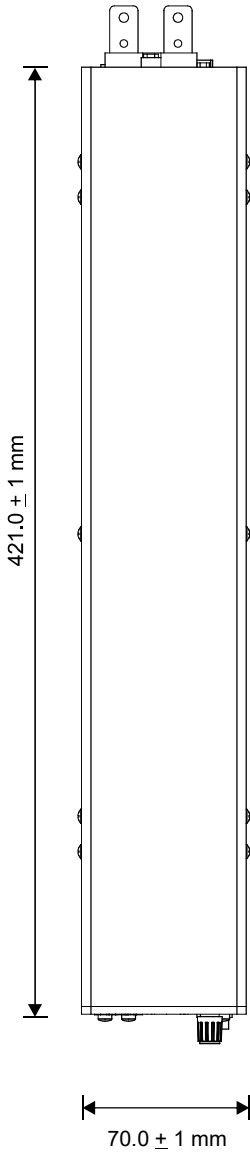

**Output bus dimension :**

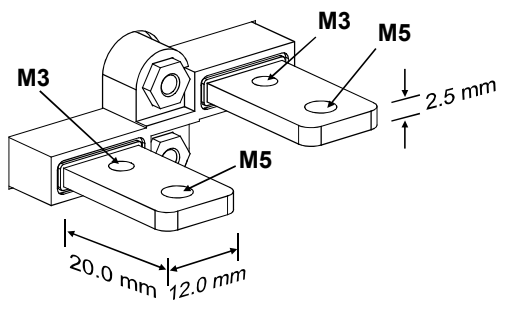



## Chapter 2 Panel controls

### 2.1 Front panel controls

The front panel controls are arranged ergonomically to ease in operation with indicators. Before using the power supply unit, please read the following explanation to each control, terminals and IO connectors.

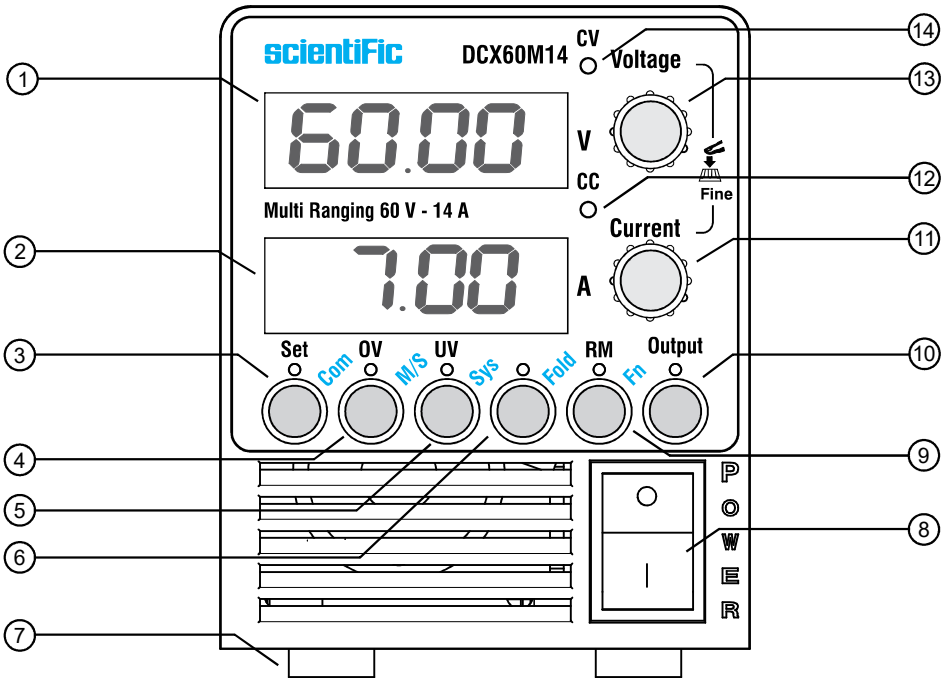

- ① Display Voltage : 4 digit display for setting and measured of output voltage.
- ② Display Current : 4 digit display for setting and measured of output current.

- ③ Set : Push button control for selecting setting for voltage or current. When pressed in combination with “RM” button, “Comm” mode selected. Comm mode used for communication parameters. Associated LED above the button, lights when voltage and current settings selected.
- ④ OV : Push button control for selecting setting for over voltage. Associated LED above the button, lights when over voltage setting is selected. When used with RM button, it is used for Master/Slave settings.
- ⑤ UV : Push button control for selecting setting for under voltage. Associated LED above the button, lights when under voltage setting is selected. When used with RM button, it is used for System settings.
- ⑥ Fold : Push button control for enabling / disabling Fold mode. Associated LED above the button, lights when fold back protection enabled. It works with Fn button.
- ⑦ Instrument Feet : Used when the power supply unit is used on table top. These are removed when used in 19” rack mount kit.
- ⑧ AC Power Switch : Mains AC power ON/Off control, when switched to ON, supplies main AC power to unit.
- ⑨ RM : Push button control for releasing instrument from Remote control. Associated LED above lights when instrument is in remote control mode. When pressed in local mode it acts as a function button for setting configuration.
- ⑩ Output : Push button to control DC output ON / Off. Associated LED above lights when the output is ON.
- ⑪ Current : Current control encoder for setting the current. When pressed, it gives fine adjustment control. When used with Menu, it is used for setting the parameters in Menu selection.
- ⑫ CC LED indicator : LED indicator for CC , lights when power supply is in constant current mode.
- ⑬ Voltage : Voltage control encoder for setting the voltage. When pressed, it gives fine adjustment control. It is also used for setting the over voltage, under voltage level settings. When used with Menu, it is used for setting the parameters in Menu selection.
- ⑭ CV LED indicator : LED indicator for CV, lights when power supply is in constant voltage mode.

## 2.2 Rear panel controls

The rear panel is arranged with mains inlet connector, output terminals and analog programming ports etc. .

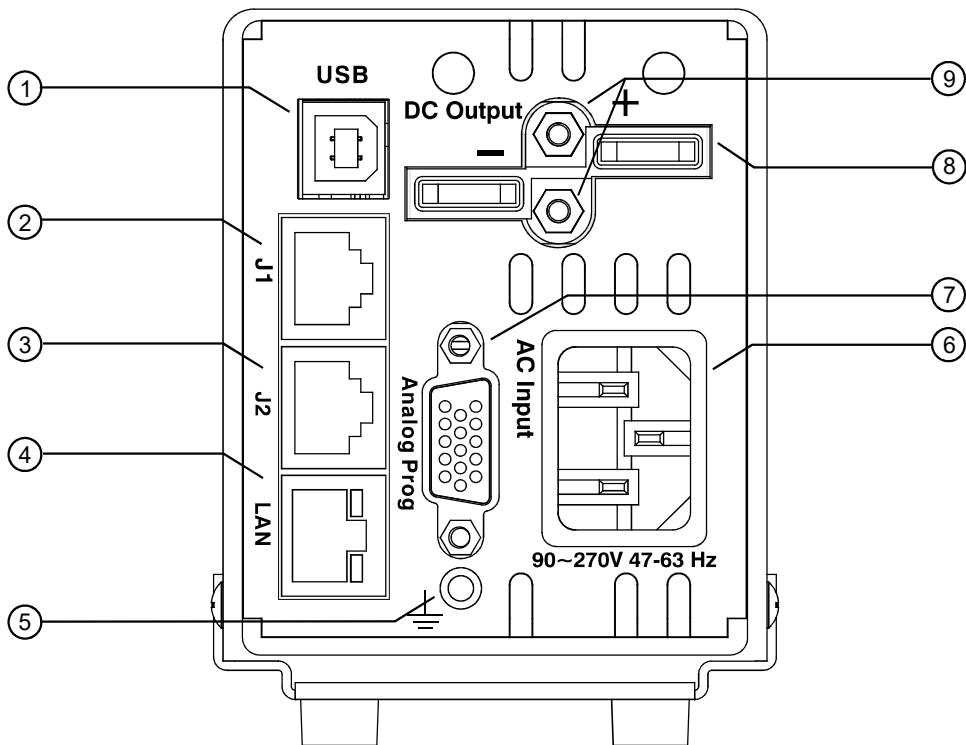

- ① USB : USB "B" connector, to connect the power supply to computer for remote control operations.
- ② J1 : RJ45 connector , gives connections for RS232, Rs485.

- ③ J2 : Slave (RJ45) Reserved for future use.
- ④ LAN : LAN ( RJ45) connector for connecting PC for remote operations.
- ⑤ Ground : 4 mm banana screw terminal for grounding the chassis.
- ⑥ AC Input : AC mains inlet socket to power the instrument.
- ⑦ Analog Programming: 15 pin (F) D type connector for remote analog programming. Refer 4.15 page 38 for details.
- ⑧ – DC Output + : DC Output Bus bars, to connect the load.
- ⑨ Sense Terminals : Remote sense terminals.

### 2.3 Sockets, connector description used on rear panel

The rear panel has different types of connections to other equipments for DC output, controlling, monitoring etc. , followings are connections for quick understanding. Detailed description on each is in specific inside the manual.

#### Output Bus Terminals + ve and - ve

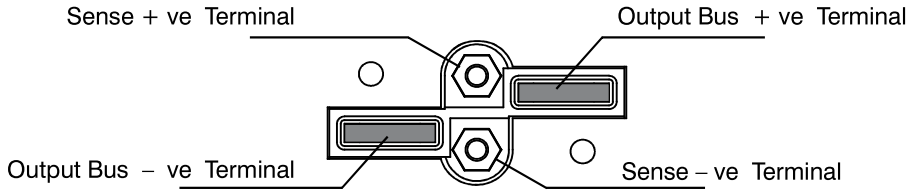

Output Bus Terminals is provided with,

1. Output Bus + ve Terminal
2. Output Bus - ve Terminal
3. Remote Sense + ve Terminal
4. Remote Sense - ve Terminal

#### Analog Programming Connector

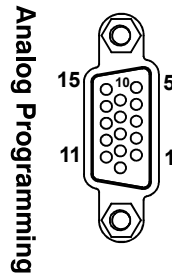

Pin 1	Vpgm Voltage Programming input
Pin 2	Ipgm Current Programming input
Pin 3	Vmon Voltage Monitoring Output
Pin 4	Imon Current Monitoring Output
Pin 5	RCVP Resistance constant Voltage Programming
Pin 6	RCCP Resistance constant Current Programming
Pin 7	Ipgm_RM
Pin 8	Vpgm-RM

Pin 9	+5 V Reference
Pin 10	Ground Analog Programming
Pin 11	RSD Remote Shut Down input
Pin 12	I share
Pin 13	Interlock
Pin 14	Reserved
Pin 15	PS OK

LAN Socket (RJ45 socket) : Standard LAN / Ethernet socket.

RS232 / Rs485 (RJ45 socket) :

- Pin 1 Return ground
- Pin 2 Not used
- Pin 3 RS485 Rx +
- Pin 4 RS485 Tx +
- Pin 5 RS485 Tx –
- Pin 6 RS485 Rx –
- Pin 7 RS232 Tx
- Pin 8 RS232 Rx

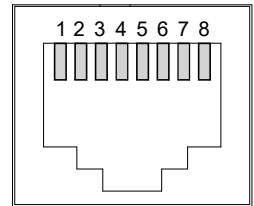

Slave (RJ45 socket) : (For future release)

- Pin 1 Return ground
- Pin 2 Slave Connect
- Pin 3 Tx +
- Pin 4 Rx +
- Pin 5 Rx –
- Pin 6 Tx –
- Pin 7 Not Connected
- Pin 8 Not Connected

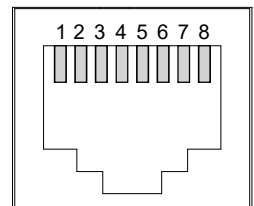

USB : Standard USB B type socket

## 2.4 Connection diagram for interface cables

To connect the power supply unit for remote control, the connecting cable wiring diagram are given below.

### 2.4.1 USB Cable

This is a standard USB cable connector type A to type B, used for connecting power supply to host ( computer or others). This is supplied as standard accessories with the unit.

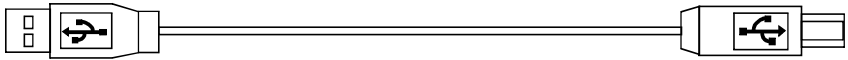

### 2.4.2 RS232/RS485 Cable

This cable is end User specific depends on the connections to remote units, panels etc. One end of this cable is RJ45 (male) and other end is DB 9 (Female) connector. User can assemble it as per their required length, but not more than 9 meter. Also available as optional accessories from Scientific.

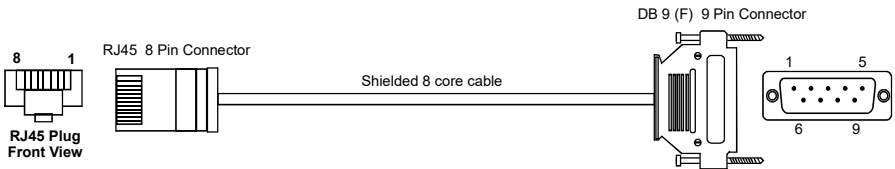

8 Pin RJ45 Connector		DB 9 (F) Connector	
Pin No.	Signal	Pin No.	Signal
1	Signal ground	5	Signal ground
2	Not connected	1	Not connected
3	RXD +	4	RXD+
4	TXD+	6	TXD+
5	TXD –	7	TXD–
6	RXD –	8	RXD –
5	Rx	3	Tx
8	Tx	2	Rx

### **2.4.3 Analog programming cable**

This is cable is end User specific depends on the connections to remote units, panels etc. To prepare cable, you will need standard DB 15 (male) connector, which connects the power supply rear panel at Analog programming connector, DB 15 (Female) connector. Depending on the required connection any good quality multi core shielded cable can be use. For pin details please refer Analog programming page 38 for connections.



## Chapter 3 Installation

Your instrument is thoughtfully designed, manufactured, tested and inspected, found free of mechanical and electrical defects. When you receive the instrument, some inspections are necessary, the condition must be understood and available before installing the instrument. Inspect the shipping container for damage if any after unpacking it. It is not recommended to use the instrument in the case of a damaged container. Keep all packing material until the inspection has been completed. If damage is detected, file a claim with carrier immediately and inform the Dealer ,sales or authorized service facility nearest to you or Scientific.

If the contents in the container do not conform to the packing list, notify us or your dealer. Before putting this instrument in operation, make sure you go through the manual, Safety and Cautions guidelines.

Ensure that the environmental conditions are fulfilled. Ensure that the instrument is not be used in place with vibrations, heating or exposed to sky , direct sunlight, for proper functioning and extensive life of service.

### 3.1 AC input mains connections

The mains AC socket ( IEC compatible ) is provided on the rear panel. Use the staight mains cord provided with the instrument , alternative ensure appropriate rating cable is used for connections as per the standard mains cord used in your country. This power supply unit can be operated from 90 V ~ 270V, 47 ~ 63 Hz.

### 3.2 Cooling

The power supply unit is forced air cooled, it has one internal fan, the speed of the fans depends on the temperature of internal heat sinks. The air movement is from front to rear. Allow approximately 10 cms of free space on front and rear

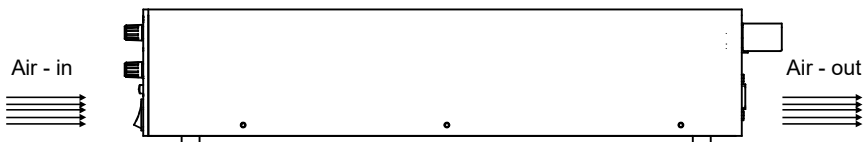

of the instrument, for free air movement. This allows stacking power supplies one above other and in 19" rack cabinets. For prolonged life of the power supply, the inlet temperature of air should be below 35°C. The instrument control circuit senses heat sink temperature, power delivered and adjust the fan speed accordingly. Thus the speed is controlled in pulsating mode, during this period , high pitch sound is produced, this is normal.

### **3.3 Use of instrument on table top**

While the power supply unit is delivered, it is ready for use on table top. No additional accessory needs to be fitted.

However, while using in 19" rack, the instrument feet needs to be removed.

### **3.4 Use of instrument in 19" rack mounting cabinet**

This power supply unit is designed to fit in standard 19" rack mount cabinet. it requires few parts to be installed before placing it in cabinet. Maximum 6 units can be fitted in 2U height in 19" , with the help of optional 19" Rack mounting kit available at extra cost. You can order these kits , depending the number of units to be fitted. These are available, on order 2, 3, 4, 5 & 6 units.

1. Use the Rack mount kit parts and fix the desired number of units, with the supplied hardware.

#### **Caution !**

Ensure that the supplied screws used for mounting only, else use appropriate screws of size M3x 6 mm. Ensure that they do not penetrate more than 6 mm inside.

### 3.5 High Voltage Protection

For safety, while using power supplies above 60V, the output terminals / Bus bars are to be protected for accidentally being touched for the safety of the operator. A Safety protection cover is provided with power supply unit as an accessory. We highly recommend to install it to avoid any potential hazard to the operator / User / personnel.

Mounting of this part is very simple. Pass the cables through the protection cover before mounting the cables on bus bar. Connect the cables on bus bar, push the protection cover to touch the rear panel and fix with the screws.

Before any making electrical connections or removing the connections, ensure the power supply bus is fully discharged. Please refer to safety instructions, before connecting / disconnecting the output connections.

#### Assembling Protection Cover on rear panel

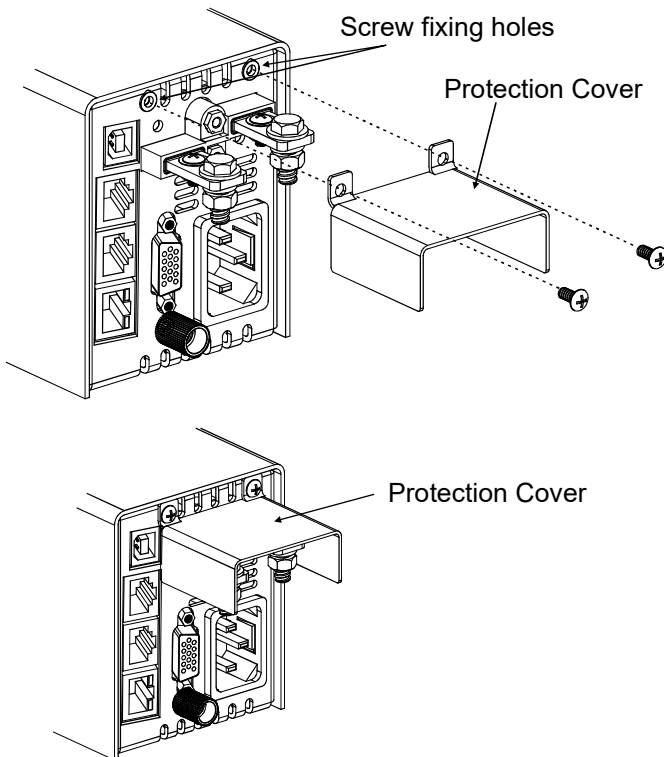

### 3.6 First time operation Power ON

Prior to power ON , ensure the followings,

- POWER On/Off switch on front panel is in Off position.
- There is no condensation on the unit, if any, allow some time to get it dry.
- Remote sense wires are connected as shown below, if not, make the connection as shown below.

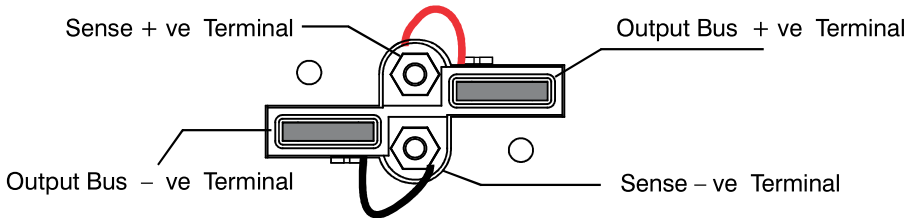

#### 3.6.1 AC mains input

This power supply unit is designed for universal mains input. The mains input can be connected from 90V to 270 V 50 Hz / 60 Hz.

#### Caution !

1. The Power Supply Unit must be connected to mains inlet having earth connection.
2. For safety the chassis of this unit is connected to protective earth potential.
3. Do not interrupt earth connection, else chassis will be floated and unsafe. Personal touching, in this case liable to get electric shock.
4. Do not touch wires connected with output terminal when the output is ON. Do not touch such parts immediately after output is cutoff. Failure to do so could result in serious injuries or could be fatal.
5. When the mains cord is connected, even in power off conditions, few components in power supply unit is still connected to the AC mains. To avoid any electrical shock, first remove the mains cord, wait for two to three minutes, before opening the instrument cover.

#### 3.6.2 Connecting to AC mains

- Connect the AC mains inlet cable, after ensuring correct AC mains availability.

- Switch the POWER switch to ON position.
- The display will light and display will show voltage as the voltage setting and current zero as the load is not connected, this means the power supply is connected to AC mains and power supply is ready to use.
- Switch the POWER switch to Off position.

### **3.6.3 DC output check**

- Connect the DVM/DMM in appropriate voltage range depending on power supply output voltage.
- Press the push button “Output”, the associated output LED will light, indicating the output is available on bus bar at the rear panel.
- Rotate the Voltage control knob, the displayed voltage will vary with knob variation.
- Observe the DMM reading and check with power supply display reading, the DMM reading should be within the stated accuracies of the output voltage.
- The minimum voltage reading is close to zero to maximum voltage as per specification of the model.
- Press the push button “Output”, the DC output will be switched off and output LED will be off.
- Switch Off the AC power switch.

### **3.6.4 DC constant current check**

- Connect the DC shunt across the power supply output terminals with appropriate cables of current capacity. Ensure that the shunt and wire capacities are more than the power supply power.
- Connect the DMM in mV range across the DC shunt .
- Switch the POWER to ON position.
- Press “Set” push button, the associated output LED will light, indicating that voltage and or current now can be set , before the output is switched ON.
- Rotate the Voltage encoder, such that the voltage set is approx. 1.00 Volts
- Rotate the Current encoder, such that the current set is approx. 1.00A.
- Press the “Output” push button, the associated output LED will light, indicating the output is available on bus bar at the rear panel.
- Observe the DMM reading and compare it with the current displayed reading, it should be in specified accuracy.
- The minimum to maximum constant current can be checked with connecting the appropriate DC shunts.
- Press the push button “Output” , the DC output will be switched off and

output LED will be off.

- Switch off the AC power switch.

These two simple tests, ensure that the power supply is largely working and further can be checked and tested for the other modes and features after going through manual.

In Description chapter, all the features and modes are explained in details. Request to go through each for better understanding and use.

## Chapter 4 Descriptions

### 4.1 Safety first - grounding

The power supply unit to be connected to the mains input as per the specification with firm protective earth grounding. The chassis of the unit is connected to ground potential. When the mains cord is connected, even in power off conditions, few components in power supply unit is still connected to the AC mains. To avoid any electrical shock, first remove the mains cord, wait for two to three minutes, before opening the instrument cover. Failure to do so will result in potential electric shock and serious injuries or could be fatal.

### 4.2 Input voltage

The power supply unit is designed for universal mains input . The mains input can be connected from 90V to 270 V 50 Hz / 60 Hz. The power supply cord must be used as per the country specific approved mains cord to avoid damage to unit and personal hazard.

There is no external fuse in the unit, a safety fuse is installed inside the unit. In event of fuse blown, the fuse must be replaced only by Scientific authorised service personal.

When power supply unit is switched ON, its inrush current is limited by internal circuitry. Switching ON and OFF at faster rate, may result in over heating of current limiter, resulting higher inrush current.

The power supply is designed with active power factor correction, therefore the power factor is very close to unity, also the input mains current is almost sine wave. It's standby power is also very low, resulting in very high efficiency and low losses - lower heat generation.

### 4.3 Operating conditions

#### 4.3.1 Temperature and humidity

The power supply can be used safely at fully from 0 ~ 50 °C, with a condition that the surrounding free air movement is maintained for cooling. The normal humidity in ambient condition do not pose any problem, the heat produced in the instrument is sufficient to keep it dry.

In case of any condensation, allow the time to get it dry, before the instrument is switched ON and kept in use.

When power supply is mounted in 19" cabinet, ensure the free air movement.

Industries and environment, with chemicals in air, e.g. chemical process industries, galvanizing industries, should take extra care to isolate the power supply unit by installing it in a clean room. This aggressive atmosphere, reacts with electronic component, damaging the parts and copper tracks etc. reducing the product life to standstill.

#### 4.3.2 Storage

The power supply unit when not in used, or for transportation, should be kept in dry place. It can be stored or transported from -20 ~ 70°C without any problems.

#### 4.4 Thermal protection

The power supply unit has thermal protection, against internal temperature when exceeds the safe limit. This only happens when adequate air circulation is not provided or very high environment temperature or in case of any fault in the unit. When this condition occurs, the power supply output gets switched OFF.

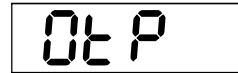

Allow some time to cool down the power supply unit, you may observe the cooling fan speed is high. Once the temperature reaches below the set safe limit, the speed of fan reduces and in few minutes and it may stop.

Once the temperature reduced and is below the safe limit, output will switched ON automatically. If the problem reappears, check for space for air movement and clear the space. If it still persists, contact Scientific or dealer close to you.

#### 4.5 Cooling

The power supply has fan installed to cool down the internal temperature. The fresh air is taken from front side and exit on rear side. There is no ventilation holes on top and bottom side, this allows number of power supplies can be stack one over other.

The speed of the fan is governed by internal circuitry, it starts at predefined temperature and power when drawn.

#### 4.6 Output

The DC output of power supply unit is switchable to ON or OFF. This can be done by pressing the output switch on front panel or remote interface.



The DC output is available on bus bar on the rear panel. The cable/ wire are connected with the help of M5 bolt and nut provided.

The output can be either CV (constant voltage) with current limiting or CC (constant current) with voltage limiting. These power supplies are design for multi-ranging, meaning it follows a constant power curve within the specified maximum voltage and current for that model.

For example model DCX60M14 allows the drawing load current of maximum 7 A up to 60 V and maintains CV mode. Similarly we can draw load current of 14 A at 30 V maintaining the CV mode.

From 60 V to 30 V the maximum current will be decided internally such that the product of voltage and current is equal to approx. 400W. It follows the curve as shown below.

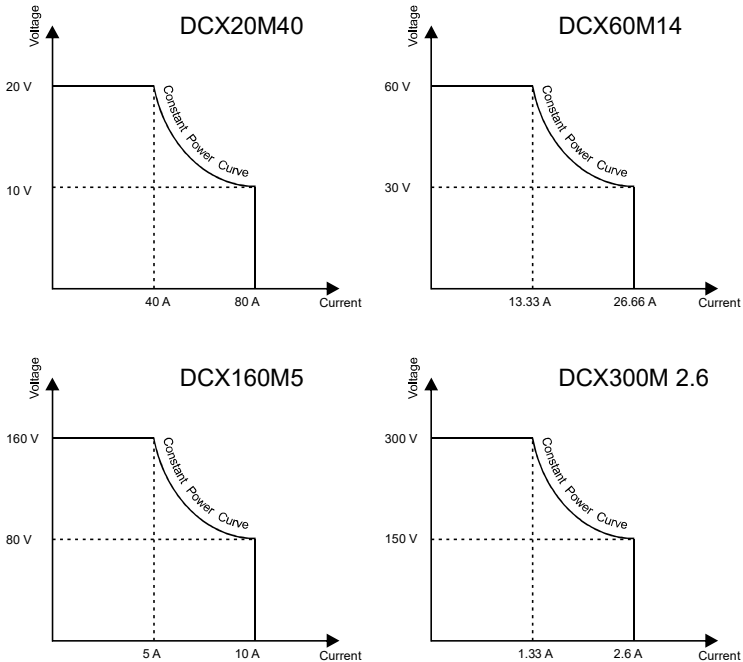

The transition of mode from CV to CC, depending on the load current is very sharp and respective LED indicators CV or CC will light on the front panel. The power supply is fully protected against all type of overload conditions including short circuit at output.

The power supply has very low ripple and noise. If needed, the ripple and noise

has to be measured directly on the sense terminals. To measure the ripple and noise very sensitive measuring instruments and probes are required. To measure the correct ripple amount, there are a few standardized methods for ripple and noise measurements. One of which is the JEITA-RC9131A standard.

#### 4.7 Connecting the load

##### Caution !

Before connecting any output cables, turn OFF the output. While output is ON , there is potential electric shock hazard where the power supply models having output voltage greater than 40 V .

While connecting the cable, observe the following steps for precaution.

- Switch OFF the unit , disconnect the mains from the unit.
- Wait un til the output capacitor gets discharge , for approximately two minutes.
- Connect the appropriate output cable on the output bus.
- If required connect the sense wires at load points, else local sense can be used.

Select the output cable / wire with power rating higher than the power supply unit ratings. The size and length of the output cable is such that at maximum load the drop across each line conductor does not exceed the maximum permissible line drop of 2 V. If the drop is more load regulation may not be maintained. In addition, there will be unnecessary power loss in cables.

The recommended cables for connecting the output are as below.

Model	Cable Size	Fixing Bolt size	Torque
DCX20M10	4 mm <sup>2</sup>	M5	20 Nm
DCX60M14	4 mm <sup>2</sup>	M5	20 Nm
DCX160M2.5	1.5 mm <sup>2</sup>	M5	20 Nm
DCX300M2.6	1.5 mm <sup>2</sup>	M5	20 Nm

The output cable is terminated with appropriate size of Copper lug. While making connection, place the copper lug directly to the bus, followed by washers and bolt. If the sequence is not followed, contact resistance will be introduced between the output bus and the cable, will cause excessive heat at bus. To reduce the output line inductance, keep both positive and negative cable close to each other.

While connecting inductive loads, care must be taken to protect power supply unit from the spikes that may produced when output is switched ON and OFF. An appropriate rating of bypass diode should be connected at the output. The cathode of diode is connected to + ve output and anode to – ve output. The diode rating must be greater that the power supply voltage and current ratings. Similarly when the inductive motors are connected as load, that may give back emf. This back emf may cause a damage to the power supply, if protective measures are not taken. Connect a suitable surge suppressor of voltage of say 10 % to 15% of the maximum voltage of power supply unit.

Ensure that the output cable/ wire connected on output terminal are securely tightened before applying the power.

#### 4.8 Local and remote sensing

In most cases, local sensing is used. Power supply units are delivered with local sensing. On the rear panel, two sense terminals are provided. Figure below shows the local sense connections.

If the voltage regulation is to be maintained at load point, external wires are to be connected to sense points. Connect the wiring as shown below. Before detaching or connecting the sense wires, switch off the power supply output, and ac mains to the unit. Wait for two minutes, until the output get discharged.

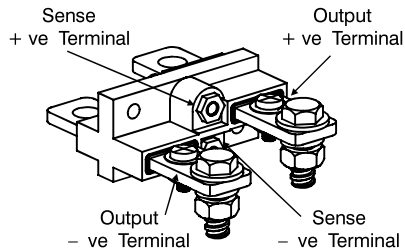

Local Sense wiring

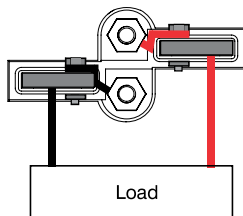

Remote Sense wiring

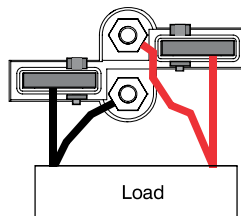

To keep the minimum external interference, the cables/ wires used to connect must be twisted pair. The wires should have good insulation to avoid any electrical contact with other equipments, ground or so. The power supply is floated and has no reference to other electrical circuit, unless physically connected. Such as grounded positive power supply where the negative output terminal is connected to protective earth potential, similarly negative power supply where the positive output terminal is connected to protective earth potential.

#### **4.9 Constant voltage and constant current mode**

Power supply can be used in either constant voltage mode - CV or constant current mode - CC. The mode is indicated by front panel LEDs. The DCA series has multi-ranging, the advantage is, it serve purpose of two models higher voltage - lower current and lower voltage - higher current in one unit.

Care must be taken while measuring ripple current voltage, it must be measured on output directly, other wise few additional length of probe wire will add few mV of noise present in the field.

While using CC mode, do not use external Remote sense, otherwise it may add error in current set. While in CC mode DC fail signal will be generated usually.

#### **4.10 Hold up time**

Hold up time is the duration of time to which the output is available, when the mains ac input is switched OFF. This time depends on the load connected, lower the load current drawn higher will be the duration. If no load is connected, you will observe the display is still ON for some time, when AC power switched to OFF. This time helps the control system in power supply to communicate the failure of AC to other systems connected.

#### **4.11 Over Voltage Protection**

Over Voltage Protection (OVP) protects the load / circuits connected to the set over voltage value. When OVP occurs, the output gets switched OFF. To enable the output, press the Output switch again. Thus it protects the load circuit, in the event of excess of output voltage in local or in remote mode of operation.

The minimum Over voltage can be set to approx. 105 % the set voltage or 1V. The maximum over voltage can be set to approximately 105 % of the maximum settable voltage range.

When Over voltage protection is not required it should be set to the maximum value.

When over voltage occurs , the output gets switched OFF and display will show “OVP”. To reset the power supply output, press the output ON/OFF switch. The power supply returns to previous state, if the voltage at output terminals diminishes, else again the over voltage protection comes into action.

A rectangular digital display showing the text "OVP" in a seven-segment font.

The setting of over voltage also works as over voltage limit, as it will not allow to set output voltage above OVP set value.

#### 4.12 Under Voltage limit

Under Voltage Limit (UV) limits the voltage setting. This useful in the event where test circuit input voltage should not go below certain level. By setting under voltage limit, it prevents accidental lowering the voltage. By using over voltage protection and under voltage limit, gives a window for sensitive circuits. Under voltage can be set from 0 V to 95% of the set output voltage. Under voltage can be set from front panel controls through Menu or from remote programming.

#### 4.13 Fold back protection

To protect the sensitive load from the set current value or from short circuit conditions, Fold back protection is used. This function can be enabled or disabled from the front panel in both cases output ON or OFF. When the function is enabled Fold LED will light. When the load current crosses set current or CC value, the output will be switched OFF. The display will show “FOLD” Once the output is switched OFF, it can be reset, by pressing Output push button.

A rectangular digital display showing the text "FOLD" in a seven-segment font.

#### 4.14 AC fail

The power supply is in use and it's mains AC input fails or it is low or it was intermittent because of bad power conditions, the power supply display will show “ACF”. It remains until the power supply has energy to support the load and the output charge gets discharged. This depends on the load connected, normally in seconds.

A rectangular digital display showing the text "ACF" in a seven-segment font.

To switch power supply again, first resolve the mains connections, and then switch ON power supply.

When power supply is in operation and you switch OFF the power supply, then also it will show the ACF on the display, however it is not a fault, just indication of AC mains switched OFF.

#### **4.15 Analog programming**

The programmable power supply can be controlled from remote analog inputs apart from the front panel controls. For controlling the power supply from external analog input, select Vana, short pin 8 Vpgm rmt to pin 10 ground. When V or I programming is selected to external, front panel encoders will be disabled.

To maintain the power supply isolation and to prevent the ground loops, use an isolated programming source.

The power supply analog input and output signals are very sensitive and precise, any external disturbances may lead to errors in setting and measurements. Use a shielded cables for the analog control signals, if unshielded cable is use, provide EMI filters, suppressor to the cable. Keep the cable lengths as short as possible.

Apart from the setting the voltage and current, there is PS OK status outputs available which helps in remotely knowing the health condition of power supply.

For measuring the voltage and current, monitor outputs are available in scale of 5 Volt. Note that, the Analog connector input signals for remote control, have reference to – ve output terminals and they are not floated. Wrong connection can cause earth loops, may cause faults. Care must be taken before connecting the analog connector after ensuring.

Analog Connector Pin layout : The connector pin layout and description is discussed in section 2.3 .

The Analog input output connector is D type 15 pin Female connector. Use appropriate mating connector always to give firm contacts and reliable connections.

#### **4.16 Description of analog connector pins and their application**

**Pin1 V Prog** - Voltage Programming input :

In remote analog programming, to control the output voltage, V programming set value is fed to pin 1. Programming voltage in the scale of 5 V is applied.

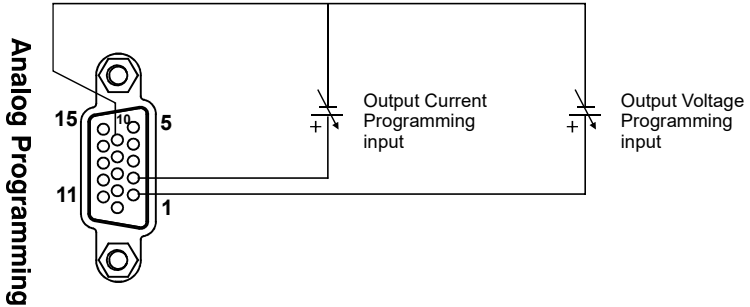

The relation between the  $V_{set}$  and  $V_{out}$  is ;

$$V_{set} = (5 \times V_{out}) / V_{rated}$$

where  $V_{set}$  is voltage to be fed to pin 1 ;  $V_{out}$  is required output voltage ;  $V_{rated}$  is the rated output voltage of power supply unit

e.g. : in DCX60M14 model  $V_{rated}$  is 60V , and we wish to set output to 40V, then  $V_{set}$  will be  $(5 \times 40) / 60 = 3.33 \text{ V}$

**Pin 2 | Prog** - Current Programming input :

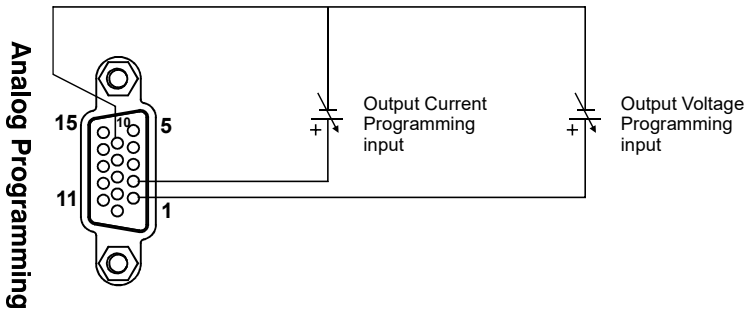

In remote analog programming, to control the output current  $I_{programming}$  set value is fed to pin 10. Programming voltage in the scale of 5 V is applied.

The relation between the  $I_{set}$  and  $I_{out}$  is ;

$$I_{set} = (5 \times I_{out}) / I_{rated}$$

where  $I_{set}$  is voltage to be fed to pin 2 ;  $I_{out}$  is required output current ;  $I_{rated}$  is the rated output current of power supply unit

e.g. : in DCX60M14 model  $I_{rated}$  is 14.0A , and we wish to set output to

10.00A , then Iset will be  $(5 \times 10.0) / 14.0 = 3.57 \text{ V}$ .

**Pin 3 V Mon - Voltage Monitor output & Pin 4 I Mon - Current Monitor output :**

In remote analog programming, you can monitor the output voltage and current on external measuring device e.g. on Digital Multimeter. The monitor outputs is in the scale of 5 V. These outputs are with reference Pin 8 ground / return path.

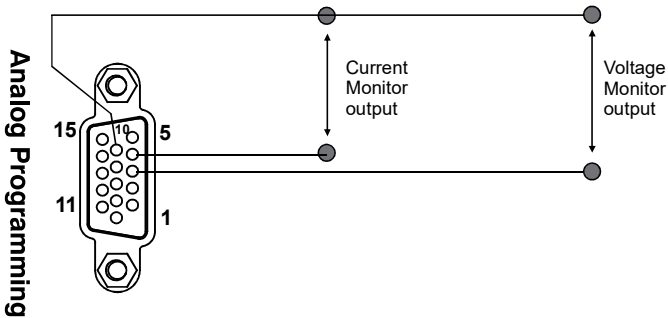

The relation between the Vmonitor and Vout is ;

Vmonitor with 5 V reference ;

$$V_{\text{monitor}} = (5 \times V_{\text{out}}) / V_{\text{rated}}$$

where Vmonitor is output voltage from pin 3 ; Vout is output voltage ; Vrated is the rated output voltage of power supply unit

e.g. : in DCX60M14 model V rated is 60V , and if the output voltage is 40V, then V monitor will be  $(5 \times 40) / 60 = 3.3 \text{ V}$  .

Imonitor with 5 V reference ;

$$I_{\text{monitor}} = (5 \times I_{\text{out}}) / I_{\text{rated}}$$

where Imonitor is output voltage from pin 4 ; Iout is output current ; Irated is the rated output voltage of power supply unit

e.g. : in DCX60M14 model I rated is 14.0A , and if the output current is 7.0 A, then I monitor will be  $(5 \times 7) / 14.0 = 2.5 \text{ V}$  .

**Pin 5 & Pin 6 Resistor Voltage and Current Programming**



A known resistance proportional to the desired voltage and current can be connected between Pin 5 and Pin 10 to adjust the voltage and between Pin 6 and Pin 10 for current settings. The resistor programming is corresponds to 5k Ohms as full scale value.

**Pin 7 I<sub>PGM\_RM</sub>**

Short Pin 7 to Pin 10 (ground) , to enable current analog programming from remote.

**Pin 8 V<sub>PGM\_RM</sub> :**

Short Pin 8 to Pin 10 (ground), to enable voltage analog programming from remote.

**Pin 9 Reference Voltage output + 5V :**

When power supply is to be controlled through remotely using external potentiometers, this reference voltage can be used as reference supply to potentiometers. The potentiometer value must be 10 k Ohms or higher to avoid any loading effect on reference voltage.

**Pin 10 Ground Analog Programming :**

Ground terminal for Analog Programming inputs.

**Pin 11 RSD Remote Shutdown input :**

In remote programming, the output of power supply can be remotely switched OFF by applying TTL ( 5 V) at pin 11 of analog connector , with reference to ground at Pin 10. The power supply remain switched OFF, until the TTL voltage is goes 0V. To enable the RSD, select RSD logic = High from front panel setting.

**Pin 11 & Pin 13 Interlock**

Interlock mode is used in series with external switch to enable the DC output to OFF , with external switch is ON. Connect a switch between Pin 12 and Pin 13 to use this function. Note that these pins are not potential free, they must be isolated from any other circuit. To enable Interlock, select RSD logic = High from front panel setting.

**Pin 12 : I<sub>share</sub>**

Used for Master/Slave operation.

**Pin 14 : Not used (NC)**

**Pin 15 PS OK**

The power is healthy when the PS OK status is logic High.

#### **4.17 Safe start - auto start mode**

When the power supply AC mains switch is pressed, ON, the DC output state can be controlled. The output can be made ON with mains AC ON, or OFF with mains AC ON. To select mode, set it ON in Menu facton. Refer 5.10 for setting.

#### **4.18 Last save memory**

When power supply is switched OFF , it records the setting and save it in memory. When next mains switched ON , the save setup is loaded.

Following settings are saved, with each mains switch OFF.

1. Set voltage
2. Set current
3. Over voltage level
4. Under voltage level
5. Baud rate
6. Communication mode
7. Power supply address
8. Last status of Output ON, if selected.

#### **4.19 Front panel locking**

You can lock the front panel of power supply, to protect the settings against any accidental change of functioning of any push button pressed or encoder settings. Refer 5.8 for settings.

#### **4.20 Remote control mode in RS232, RS485, USB and Ethernet (LAN)**

The DCX60M14 power supplies can be remotely controlled over RS232, RS485 USB and LAN. End user can use SCPI commands in their control software. All the front panel functions are available on remote host. When the power supply unit is remotely accessed, all the front panel control push buttons gets locked, except push button "RM". By pressing push button "RM", power supply returns to local control mode, and can be controlled from front panel. Remote also can be disabled from remote host. To connect the power supply unit to remote host use appropriate connecting cable. The connecting ports are on rear panel of the unit. The cable wiring diagram is given in this manual helps to fabricate if not available and to ensure that the correct cable is being used. From the front Menu setting, it is possible to select the interface to use RS232, RS485 ,USB or LAN, along with the respective parameter settings.

#### **4.21 Connecting load**

The load is connected on rear panel bus of power supply unit. The connecting wires/ cables should be of appropriate size, with good insulation. The power supply has floated output, this allows, if required the either of terminal can be

connected to ground as per the load requirements. This means a positive or negative power supply can be configured. While connecting load wire / cables, ensure that the power supply is switched OFF, wait for few minutes, until the output charge is discharged. Disconnect the mains, connecting the output wires and sense wires in local or remote sense as the case may be. Never change or remove the sense wire in power supply ON conditions, doing so it may cause a damage to the power supply unit as well as it's dangerous to do so for the person working on it.

**Connecting single loads**

The load can be connected in either in local sense or in remote sense mode. In case of local sense mode the sense points are at output bus , where as when precise regulation is required at load points, the sense wires are connected across the load.

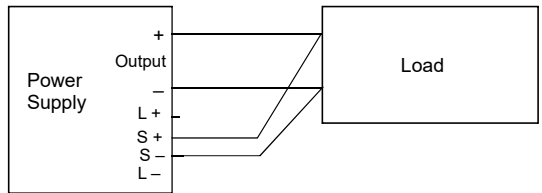
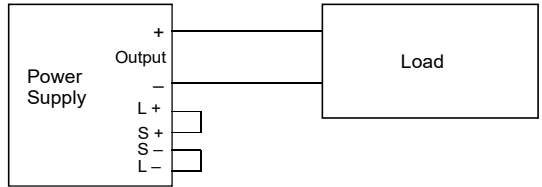

When the regulation is critical, remote sense to be used. Remove the local sense connections and move these sense wires to load end as shown in figure.

While in remote sense, the sense wires should be twisted and or to be shielded to avoid any influence of surrounding noise. The sense wire length should be optimized to get the shortest length.

**Connecting multiple load**

When connecting multiple load, the loads can be connected directly on the output bus of power supply with local sensing or the power supply output can be connected to common bus, on which the multiple loads can be distributed. The regulation at common bus can be maintained by connecting the remote sense wires on common bus.

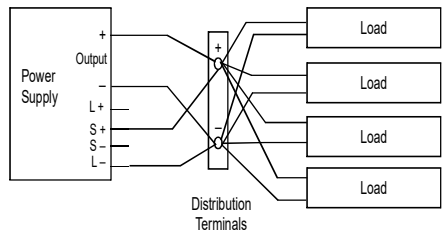
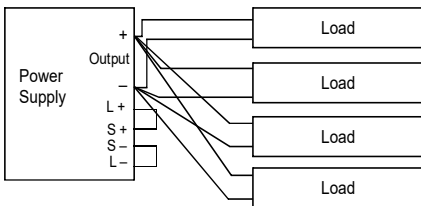

## 4.22 Connecting power supplies in series & parallel

To increase the current or voltage rating of power supply system, it is possible to connect the power supplies in series for increasing the voltage rating and connecting in parallel to increase the current rating. While connecting ensure that the models are same. Do not connect other models in series or in parallel, else there are possibilities of damaging the power supply units.

When the power supplies are connected in series the maximum output voltage will be the addition of all the units connected in series. Total maximum added output should be less than 600V.

In Remote control in analog programming care must be taken, the programming voltage fed has reference to output negative terminal and when the power supplies are in series the input programming voltage must be isolated else the power supplies connected will be short circuited through analog programming connectors return points / reference grounds.

When the power supplies are connected in parallel the current capacity gets multiplied by the number of units in parallel. There is no limit on number of power supplies connected in parallel.

## 4.23 Power supply as battery charger

The DCX 400 series power supplies can be used as battery charger, CV/CC mode regulates the charging current. To protect the power supply, use a circuit breaker in series with charging cable. In the event of excess current or reverse polarity the circuit breaker will disconnect in very short time. The circuit breaker should have double the battery voltage and fast acting (normally type Z). In case of accidental polarity reversal large amount of current will flow through the power supply, which will damage the power supply. A bypass diode should be connected in parallel to output terminal to protect the power supply. The diode should be of higher rating and should have high heat dissipating capability.

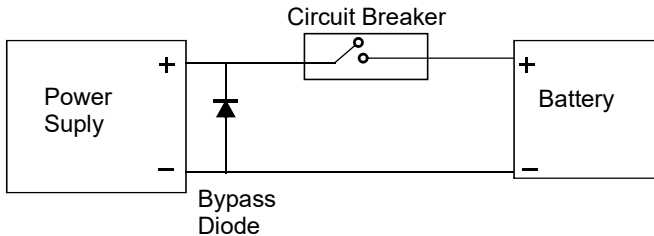

## Chapter 5 Menu controls

The most of the functions are enabled and controlled through Menu setting. The front panel has six push button switches and two encoders.

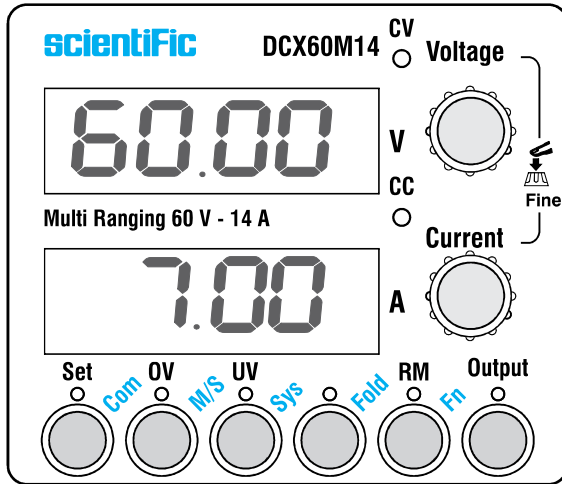

The front panel controls are ergonomically arranged to ease in operation. Two encoders, named as Voltage and Current are used to select the modes, analog programming and parameters, while in Menu selection.

On following pages, menu settings are described. Follow the sequence of pressing of push buttons as described. By pressing any of push button assigned function is selected. If you press it again, the display will return the previous displayed value with updates. If the push button is left as it is, menu will get exit automatically after predefined time, it's approx. 10 seconds.

### 5.1 Power ON switching

With default or factory setting, when the power supply is switched ON, the display indicates "OPOFF"

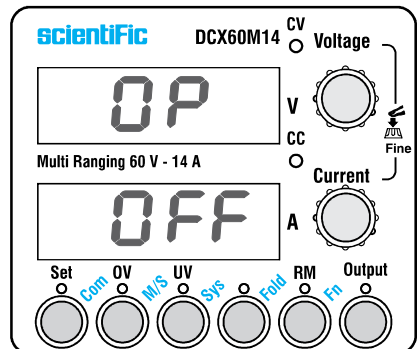

**5.2 Voltage & Current setting :** To set the desired voltage or current, press “set” push button, the set LED will light and the display will show previous voltage current set values. To set the new value of voltage, rotate Voltage encoder until the desired value displayed.

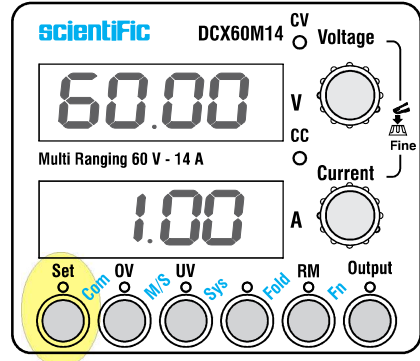

Similarly to set the new value of current, rotate Current encoder until the desired value displayed.

The voltage and current can also be set or changed in output ON condition.

The encoder when moved one step changes value on third digit (coarse), to increase the resolution, press the encoder switch again, the resolution will be changed to second digit (medium), to increase further to first digit (fine) press encoder once more. With next pressing encoder will return to resolution at third digit. The default step resolution is at second digit.

**5.3 Over Voltage setting**

To set the Over Voltage protection value, press “OV” push button. OV LED will light and display will show the previous over voltage set value.

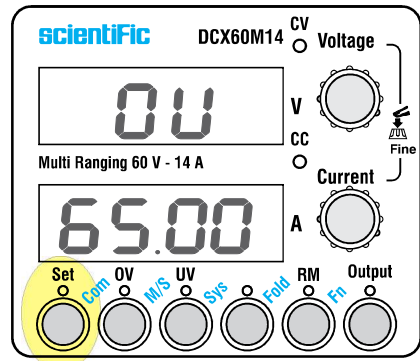

To set the new over voltage protection value, rotate voltage encoder. The new changing value is displayed. You can change the encoder resolution in coarse, medium or fine by pressing voltage encoder switch.

The minimum Over voltage can be set to approx. 105 % the set voltage or 1V.

You can not set over voltage value lower than 1 V. The maximum over voltage can be set to approximately 105 % of the maximum settable voltage.

When Over voltage protection is not required it should be set to the maximum value.

## 5.4 Under Voltage setting

To set the Under Voltage protection value, press “UV” push button. UV LED will light and display will show the previous under voltage set value.

To set the new under voltage limit value, rotate voltage encoder. The new changing value is displayed. You can change the encoder resolution in coarse, medium or fine by pressing voltage encoder switch.

The maximum under voltage can be set to approx. 95 % the set voltage. The minimum under voltage value can be set to 0V.

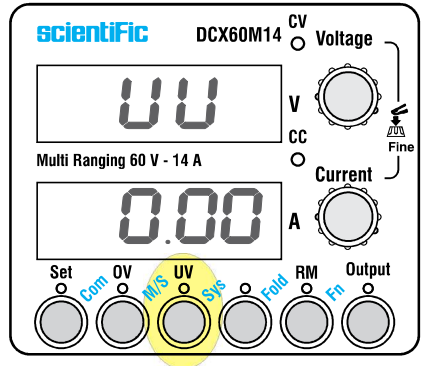

## 5.5 Fold back protection

To enable Fold back protection, press “Fn” + “Fold” push buttons. Select CV / CC or Off. If CV / CC is selected Fold is enabled and LED is lit. You can also select Fold delay time.

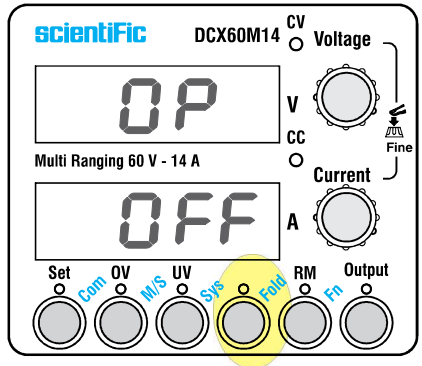

## 5.6 Output On / OFF

To enable the output, press “Output” push button. The output LED will light. The display will show the measured output voltage and current. While the output is ON, you can change the voltage and current by encoders. You can also access “Set”, “OV”, “UV” and “Fold” menu in output ON state.

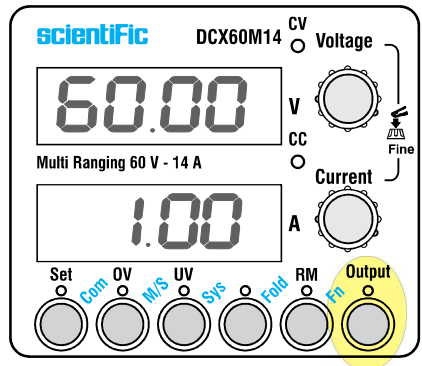

## 5.7 Communication set menu

The communication menu is selected by pressing the “RM” push button, followed by “Set” push button. For the first time / default the display will be as below;

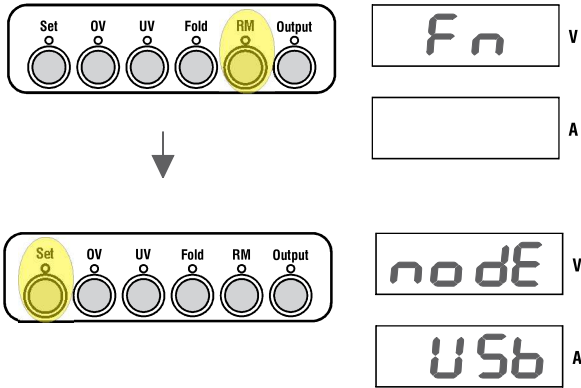

By varying voltage encoder you can select mode , baud and address.

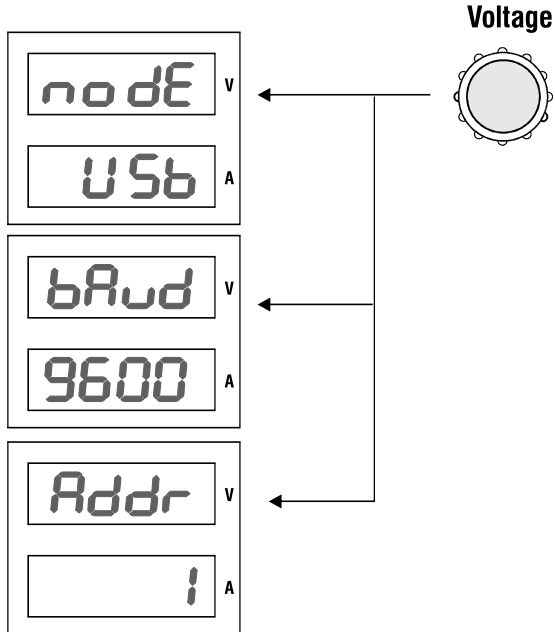



By varying current encoder mode parameters can be changed when mode is selected. Modes are ;

- USB
- RS232
- RS485
- LAN

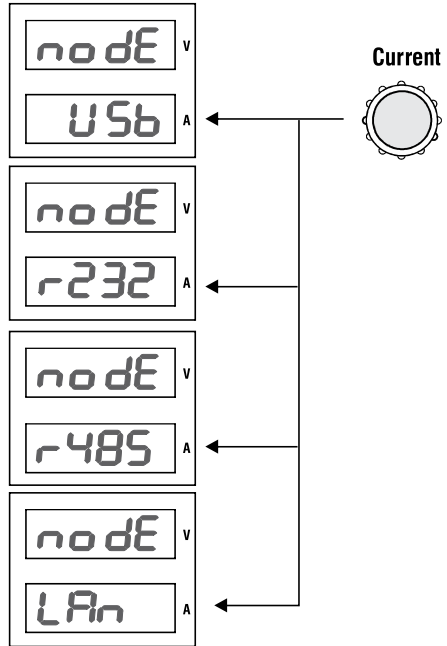

By varying current encoder baud parameters can be changed to 4800, 9600 and 19.2k, when baud is selected.

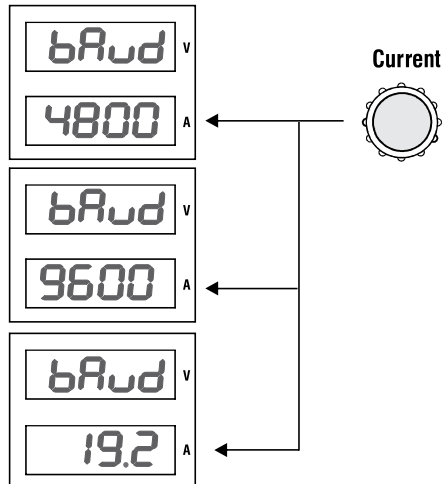

By varying current encoder address can be changed when Address is selected. The address range is 1 to 30.

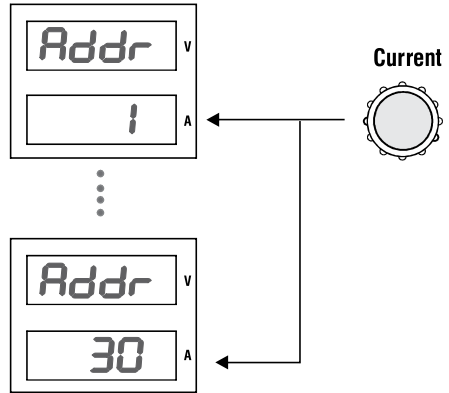

### 5.8 Front panel lock

You can lock the front panel of power supply, to protect the settings against any accidental change of functioning of any push button pressed or encoder settings.

To select this function, press push button “RM” and then Current Encode knob in sequence, the display will show FP in voltage window and LOC in current window.

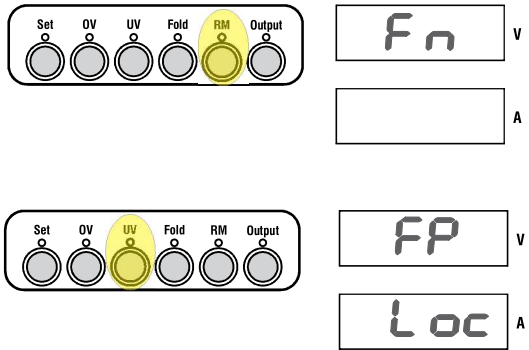

To unlock the front panel, press push button “Fn” and then press Current Encode knob in sequence, the display will show FP in left window and UnLc in right window. the panel will be unlocked.

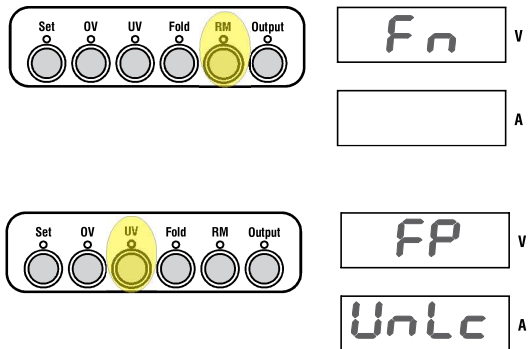

## Chapter 6 Communication interface protocol

The power supply series DCX400 has communication command words, which includes some of SCPI (Standard Commands for Programming Instruments).

Followings are guidelines, to enable End User program to set up communication between the power supply unit and the host (computer).

- The syntax commands may be sent, in any case , lower, upper or mixed.
- The first command to be sent, is power supply unit address.
- Commands with ? is a quarry and power supply unit sends a response to it.
- Space between the command and argument is denoted by <sp>.
- The data string is 8 bit, 1 start bit and 1 stop bit.
- Port address for Ethernet is set on "5000".
- No parity bit is used.
- End of message is Carriage Return (ASCII 13) or \r\n .
- On every command sent to power supply unit is acknowledged by OK or with argument reply.

### 6.1 SCPI Commands:

These SCPI commands are specific to Scientific DCX 400 W series. These are not case sensitive, use complete SCPI text command in full. The power supply when connected in remote control, the first command is CH <PS\_address>. Setting the power supply address is explained in 5.85. The front panel of power supply will be locked and Remote LED will light, which indicates, the power supply is in remote control mode.

S. No.	Command Syntax	Description
1	CH <PS_address>	Remote mode enable. Power supply returns : REMOTE MODE ON ,PS_address is power supply address from 1 to 30. Default address value is 1.
2	EXIT	Remote mode disable. Power supply returns : REMOTE MODE OFF
3	*IDN?	Read instrument identity. This command used to identify the unit connected on remote, returns the Instrument Model number. Power supply returns: DCX60M14 Vx.xx . Examples shown above is in case of DCX60M14. Return reply indicates instrument model DCX60M14 is connected.

S. No.	Command Syntax	Description
4	SO:VO <xx.xxxx>	Set output voltage. This command is used to set the output voltage of power supply. Power supply return : OK. xx.xxxx is set voltage numeric value in Volts, e.g. 10.0500. It may be full number or with decimal values. The set value is displayed on the power supply front panel for few seconds and disappears. The display returns to its previous position.
5	SO:CU <xx.xxxx>	Set output current. This command is used to set the output current of power supply. Power supply returns : OK. xx.xxxx is set current numeric value in Amperes. It may be full number or with decimal values. The set value is displayed on the power supply front panel for few seconds and disappears. The display returns to its previous position.
6	SO:UV <xx.xxxx>	Set Under Voltage limit. This command is used to set the under voltage limit. Power supply returns : OK. xx.xxxx is set voltage numeric value in Volts. It may be full number or with decimal values. The UV setting range is from 0V to 5% less than the present set value e.g. in DCX60M14 the set value is 40 V , the UV can be set from 0 V to 38V ( 40V -5% ). The set value is displayed on the power supply front panel for few seconds and disappears. The display returns to its previous position.
7	SO:OV <xx.xxxx>	Set Over Voltage protection. This command is used to set the over voltage protection. Power supply returns : OK. xx.xxxx is set voltage numeric value in Volts. It may be full number or with decimal values. The OV setting range is from 5% above the present V set value to maximum of Vrated approx. e.g. in DCX60M14 the V rated is 60V , and the present set value is 40V then OV can be set from 42V ( 40V + 5% ) to 60V. The set value is displayed on the power supply front panel for few seconds and disappears. The display returns to its previous position.

S. No.	Command Syntax	Description
8	OUTP 1	Set output On / OFF. This command is used to ON/OFF the output of power supply. Power supply returns : OP ON. To switch OFF the output; send OUTP 0 , Power supply returns: OP OFF.
9	SO:VO?	Read set voltage. This command returns the set voltage of power supply : xx.xxxx, for ex. 10.0000, this means the output voltage is 10.0000 V.
10	SO:CU?	Read set current. This command returns the set current of power supply. Power supply returns : xx.xxxx , for example 10.0000, this means the output current is 10.0000A.
11	SO:UV?	Read Under Voltage set limit. This command returns the under voltage set limit of power supply : xx.xxxx , for example 10.0000, this means the under voltage set is 10.0000 V.
12	SO:OV?	Read Over Voltage protection set. This command returns the over voltage protection set of power supply. Power supply returns : xx.xxxx , for example 10.0000, this means the over voltage protection is set to 10.0000 V.
13	VOLT?	Read measured output voltage. This command returns the measured output voltage of power supply. Power supply returns : xx.xxxx , for example 10.0000 is measured output voltage.
14	CURR?	Read measured output current. This command returns the measured output current of power supply. Power supply returns : xx.xxxx , for example 10.0000, this means the measured output current is 10.0000A.
15	FOLD 0 FOLD 1 & FOLD 2	Fold back enable / disable. This command is used to ENABLE the fold back protection of power supply. Power supply returns : FOLD ON , OFF or CC or CV depending up on the selected Fold back. To disable Fold back, send FOLD 0, send FOLD 1 for Fold in CC, send FOLD 2 for fold in CV mode.

S. No.	Command Syntax	Description
16	TEMP?	Read measured internal temperature. This command is used to read the internal temperature of power supply. Power supply returns : xxx.x °C , for example 100.0°C, this means the internal temperature of power supply unit is 100.0°C.

## 6.2 Additional Control Commands

There are set of other control commands, which commonly used in industries and research organizations. These are listed below.

S. No.	Command Syntax	Description
<b>Initialization Control Commands</b>		
17	ADR n	ADR is followed by address, which can be 0 to 30 and is used to access the power supply.
18	CLS	Clear status. Sets FEVE and SEVE registers to zero
19	RMT	Sets the power supply to local or remote mode: 1. RMT 0 or RMT LOC, sets the power supply into Local mode. 2. RMT 1 or RMT REM, sets the unit into remote mode. 3. RMT 2 or RMT LLO, sets the unit into Local Lockout mode (latched remote mode).
20	RMT?	Returns to the Remote mode setting: 1. "LOC" - The unit is in Local mode. 2. "REM" - The unit is in Remote mode. 3. "LLO" - The unit is in Local Lockout (latched remote) mode.
21	MDAV?	Returns MD MODE OPTION Status. 1 indicates installed and 0 indicates not installed.

S. No.	Command Syntax	Description
22	\	Repeat last command. If \<CR> is received, the power supply will repeat the last command.
<b>ID Control Commands</b>		
23	IDN?	Returns the power supply model identification as an ASCII string
24	REV?	Returns the software version as an ASCII string.
25	SN?	Returns the unit serial number. Up to 12 characters.
26	DATE?	Returns date of last test. Date format: yyyy/mm/dd
<b>Output Control Commands</b>		
27	PV n	Sets the output voltage value in Volts. Returns the set voltage.
28	PV?	Reads the output voltage setting. Returns the string "n" where "n" is the exact string sent in the PV n command. When in Local mode, returns the PREVIEW (front panel) settings in a 5 digit string.
29	MV?	Reads the measured output voltage. Returns a 5 digits string. Example: 60V supply sends 01.150, 15.012, 50.000, etc.
30	PC n	Set the Output Current value in Amperes.
31	PC?	Reads the Output Current setting. Returns the string "n" where "n" is the exact string sent in the PC n command. When in Local mode, returns the PREVIEW (front panel) settings in a 5 digit string.

S. No.	Command Syntax	Description
32	MC?	Reads the measured Output Current. Returns a 5 digit string. Example: 200A supply sends 000.50, 110.12, 200.00, etc.
33	DVC?	Display Voltage and Current data. Data will be returned as a string of ASCII characters. A comma will separate the different fields. The fields, in order, are: Measured Voltage, Programmed Voltage, Measured Current, Programmed Current, Over Voltage Set Point and Under Voltage Set Point. Example: 5.9999,6.0000,010.02,010.00,7.500,0.000
34	FILTER?	Returns the A to D Converter filter frequency: 18,23 or 46 Hz.
35	OUT n	Turns the output to ON or OFF. OUT 1 (or OUT ON)-Turn On. OUT 0 (or OUT OFF)-Turn Off
36	OUT?	Returns the output On/Off status string. ON - output On. OFF - output Off.
37	FLD n	Sets the Foldback protection to ON or OFF. FLD 1 (or FOLD ON) - Arms the Foldback protection FLD 0 (or FOLD OFF) - Cancels the Foldback protection. Sending FLD 2 , will make Fold mode to CV. When the Foldback protection has been activated, OUT 1 command will release the protection and re-arm it, while FLD 0 will cancel the protection.
38	FLD?	Returns the Foldback protection status string: "ON" - Foldback is armed. "OFF" - Foldback is cancelled.
39	FBD nn	Add (nn x 0.1) seconds to the Fold Back Delay. This delay is in addition to the standard delay. The range of nn is 0 to 255. The value is stored in eprom at AC power down and recovered at AC power up.



S. No.	Command Syntax	Description
40	FBD ?	Supply returns the value of the added Fold Back Delay.
41	FBDRST	Reset the added Fold Back Delay to zero.
42	OVP n	Sets the OVP level.
43	OVP?	Returns the setting “n” where “n” is the exact string in the user’s “OVP n”. When in Local mode, returns the last setting from the front panel in a 4 digit string.
44	OVM	Sets OVP level to the maximum level.
45	UVL n	Sets Under Voltage Limit. Value of “n” may be equal to PV setting, but returns “E06” if higher.
46	UVL?	Returns the setting “n” where “n” is the exact string in the user’s “UVL n”. When in Local mode, returns the last setting from the front panel in a 4 digit string.
47	AST n	Sets the Auto-restart mode to ON or OFF. AST 1 (or AST ON): Auto restart On. AST 0 (or AST OFF): Auto restart Off.
48	AST?	Returns the string auto-restart mode status.
49	MODE?	Returns the power supply operation mode. When the power supply is On (OUT 1) it will return “CV” or “CC”. When the power supply is OFF (OUT 0 or fault shutdown) it will return “OFF”.
50	MS?	Returns the Master/Slave setting. Master: n= 1, 2, 3, or 4 Slave: n=0
<b>GLOBAL OUTPUT COMMANDS</b>		
51	GRST	Reset. Brings the power supply to a safe and known state: Output voltage: 0V, output current: 0A, OUT: Off, Remote: RMT 1, AST: Off OVP: Max, UVL: 0. The conditional register (FLT and STAT) are updated. Other registers are <i>not</i> changed. Non-Latching faults (FB, OVP, SO) are cleared, OUT fault stays

S. No.	Command Syntax	Description
<b>GLOBAL OUTPUT COMMANDS</b>		
52	GPV n	Sets the output voltage value in volts. The range of voltage values is shown in Table 7-5. 'n' may be up to 12 char plus dec. pt
53	GPC n	Program the output current value in amperes. The range of current values is shown in Table 7-6. 'n' may be up to 12 char plus dec. pt
54	GOUT	Turns the output to ON or OFF: "OUT 1/ON" = turn on "OUT 0/OFF" = turnoff, clears CV and CC bits in the Status Condition (STAT). OUT ON will respond with "E07" if the output cannot be turned on because of a latching fault (OTP< AC, ENA, SO) shutdown.

## **Chapter 6 Maintenance**

There are no user serviceable part inside the power supply unit. The instrument is carefully tested and calibrated using standards traceable to National Laboratories. To prevent electrical shock, do not remove cover. If you have any questions concerning the maintenance or operation, contact Scientific Customer Support or nearest dealer to you.

No User internal calibration is required during the operational life time of power supply unit. Do not open the power supply unit cover, there exists high voltage points on the PCB circuitry. Only qualified and trained technical person understanding the potential hazards is expected to handle the inside faults if any.

In such case we recommend to send the power supply unit to Scientific for service and repairs.

In case of power supply failure, when it needs service / repairs , there is no User repairs or replaceable parts inside the power supply unit. No User replaceable parts are listed in this manual. Repairs are only made by manufacturer or by authorized service facilities.

No periodic maintenance is required except to take care of your instrument by cleaning the exterior of the instrument regularly with a dusting brush. Dirt which is difficult to remove on the casing & plastic parts, can be removed with a moist cloth ( 99% water, 1% mild detergent) spirit or washing benzene(petroleum ether) can be used to remove greasy dirt. Under no circumstances the cleaning fluid should get into the instrument. The use of cleaning agents can attack the plastic & paint surfaces.

### **6.1 Troubleshooting**

These power supply units are designed for continuous use, as such there are very less probabilities of failures. However, in the event of failure following first hand troubleshooting will help to diagnosis the problem. If the problem is still not solved, please contact nearest dealer to you or Scientific Customer Support giving full details.

	Problem Symptoms	Checks and solutions	
1	No Output	1.1	When power switch is ON no display , no output. Check the mains cord continuity. if faulty replace.
		1.2	Display is ON, but no output even pressing output button to ON. Check if the output cable is shorted. if faulty replace.
		1.3	Check if sense block wires are open or wrongly wired. if yes place it correctly S+ to positive and S- to negative bus outputs.
		1.4	Check if voltage and current both potentiometers are set to zeroes, if yes move potentiometers to desired values.
		1.5	Check the OVP LED lights, if yes over voltage has occurred, remove the conditions and reset the over voltage protection by pressing Output push button.
		1.6	Check for the Over temperature conditions, if yes remove the conditions and reset the output by pressing output push button.
2	Voltage and or Current encoders not working	2.1	Check if the power supply is in Remote analog programming mode. If yes bring the switches to manual mode.
3	Remote Programming does not work	3.1	Check if the power supply unit remote programming is not selected from the rear panel slide switch settings.
		3.2	Check if , analog programming voltages has higher DC offset. if yes , reduce it or use floated / isolated programming input signals.

	Problem Symptoms	Checks and solutions	
4	Output voltage is higher than set value	4.1	Check if the sense wires are open at sense block or at load end if used remote sensing. If yes re-wire the same.
		4.2	Check if the output cable is too long and of lower rating. Reduce the output cable to the possible length and increase the cable capacity using higher cross section cable.
5	High Ripple voltage present of output	5.1	Check if the sense wires are open and output cable is too long. if sense wires open, re-connect the sense wire.
		5.2	Check if Remote sense is used and sense wires are too long and hanging. if yes, optimize the wire lengths and use twisted pair for sense wires.
6	There is no Fuse visible	6.1	There is no user replaceable fuse in the power supply. Only inside power supply unit there are fuses to protect the fault conditions. In case of these gets open, only Scientific qualified or authorized trained personal should replace the fuse.
7	Others	7.1	If fault still persist, the power supply unit should be sent to Scientific for necessary repairs. Please follow the instructions given in Dispatch procedure for servicing the power supply units on next page, before sending the unit.

## **Chapter 7 Dispatch procedure for service & warrantee**

### **7.1 Dispatch procedure for service**

No user serviceable parts are inside the instrument, should it become necessary to send back the instrument to factory for service, please observe the following procedure :

Before dispatching the instrument please write to us giving full details of the fault noticed.

1. After receipt of your communication, our service department will advise you whether it is necessary to send the instrument back to us for repairs or the adjustment is possible in your premises.
2. Dispatch the instrument (only on the receipt of our advise) securely packed in original packing duly insured and freight paid along with accessories and a copy of the faults details noticed at our Service Center or factory.

### **7.2 Warranty conditions**

Scientific warrants all its Instruments to be free from defects in material and workmanship when used under normal operating conditions in accordance with the instructions given in the manual for a period of 12 (Twelve) months from date of purchase from Scientific or its authorized dealers. The service during the warranty period will be rendered on return to factory / service center basis.

1. Its obligation under this warranty is limited to repairing or replacing at its own discretion. This warranty shall not apply to any defect, failure or damage caused by accident, negligence, mis-application, alteration or attempt to repair, service or modify in any way.
2. This warranty does not include display, fuses, batteries or accessories. This warranty is only valid with the original purchaser who must have properly registered the product within 15 days from date of purchase. No other warranty is expressed or implied.
3. When it becomes necessary to return the instrument to our Factory facility, kindly pack it carefully in the original carton or equivalent and ship it duly insured, transportation charges prepaid.
4. Your Scientific instrument is a complex electronic device and deserves the best service available by technicians thoroughly familiar with its service and calibration procedures.

Notes :

Notes :